

SEATING

Price List
USA 2025



logiflex

Table of Contents

Introduction	3	Modular Seating	24	Task Chairs	100
Update Summary	4	SIT - Bench	25	Cyrus	101
Product Map	5	SIT - Corner Bench	27	Texto	105
Our social responsibility	8	SIT - Occasional Tables	28	Texto Mesh	116
Conditions of Sale	8	Infiniti	33	Texto Lab	122
How to Use the Price List	9	Clara	45	Elie	132
Appendix A: Colors and Finishes	10	Leo	49		
Appendix B: Upholstery Specification	12	Leo Flow	57	Accessories	137
Appendix C : SIT	14			SIT - Electrical Accessories	138
Appendix D : Kick plate Colors	15	Soft Seating	58		
Appendix E : Wood Color Selection	15	Bulexi	59		
Appendix F : Backs/Seats Options for Chairs	16	Flint	62		
Appendix G : Base Options for Chairs	17	Magog	71		
Appendix H : Mechanism Options for Chairs	18	Orford	72		
Appendix I : Chairs Options	19	Taylor	73		
Appendix J : Arms Options for Chairs	20	Slim	76		
Appendix K : Legs Chairs Options	22				
Appendix L : Leo Flow Heights	23	Chairs	84		
		Madrid	85		
		Stack6	92		
		Cart	93		
		Sedia	94		
		Milan Bold	95		
		Milan	96		

Update Summary

The Seating price list presents these principal modifications:

DATE	SECTION	MODIFICATIONS
March 27, 2025	Chairs	<ul style="list-style-type: none"> The mechanism of chair 41 is being changed to 41S.

Previous updates:

DATE	SECTION	MODIFICATIONS
March 3, 2025	Modular Seating	<ul style="list-style-type: none"> Removal of the bench BC and the occasionnal tables TB1, TC, FTC, TBC2 and BFT.
	Armchairs	<ul style="list-style-type: none"> Removal of all Alpha armchairs.
	Chairs	<ul style="list-style-type: none"> Modification of Milan product pages.
	Accessories	<ul style="list-style-type: none"> Removal of the connectivity unit MH3C.
	All the Price List	<ul style="list-style-type: none"> All prices have been increased by approximately 3%.
January 14, 2025	Armchairs	<ul style="list-style-type: none"> Removal of Dean armchairs. Modification of Bulexi, Flint and Slim product codes.
October 16, 2024	Modular Seating	<ul style="list-style-type: none"> Removal of Leo models: LEO18, LEO30, LEOT, LEOC18, LEOC30, LEOCT. Addition of Leo models: PR16, PR20, PR24, PS16, PS20, PS24, PI16, PI20, PC16, PC20, TMAR16, TMAR20, TMAR24, TMAS16, TMAS20, TMAS24. Addition of Leo Flow models: PR16, PR20, PR24, PR26.
	Armchairs	<ul style="list-style-type: none"> Removal of Stelli armchairs : 6750, 6753, 6757, 6759.

Introduction



Product Map

Modular Seating

SIT - Bench p. 25

SIT - Occasional Tables p. 28

Fillers p. 32

Electrical Accessories p. 138

Infiniti p. 36

Clara p. 51

Leo p. 49

Leo Flow p. 57

Introduction

Product Map

Armchairs

Bulexi p. 59

Flint

p. 62

Magog p. 71

Orford p. 72

Taylor p. 73

Slim p. 76

Introduction

Product Map

Chairs

Madrid p. 92



Stack6 p. 99

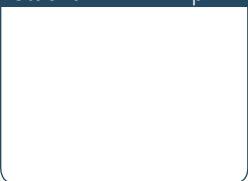

Cart p. 100



Sedia p. 94



Milan Bold p. 95



Milan p. 96



Task Chairs

Cyrus p. 109



Texto p. 113



Texto Mesh p. 124



Texto Lab p. 130



Elie p. 140





Our social responsibility

At Logiflex, we have chosen to be a responsible North American manufacturer by implementing initiatives for sustainable development. As much as possible, we source local materials and partner with suppliers who prioritize clean manufacturing processes. We also consolidate goods during transport to reduce our fuel consumption and we continually make changes that help reduce our waste production.

The company is ISO 9001 certified.

You can consult our eco-responsible approach as well as all our certifications in the [Certifications](#) section of our website. Find out how our products can help you obtain LEED credits and the Logiflex products that are Indoor Advantage Gold certified.

Conditions of Sale

Prices

The amounts listed in this document are suggested retail prices and may be changed without notice. Applicable taxes are not included. If you have an open and active account with Logiflex, merchandise will be invoiced at the prices prevailing at the time of shipment. A deposit may be requested if the opening of your account has not been completed or if your account has become inactive.

Terms of Payment

Net 30 days F.O.B. Sherbrooke, Quebec. The invoice will be assigned the shipping date and is payable 30 days from that date. Logiflex remains the owner of the merchandise until the invoice is paid in full.

Customized Products (Special Items)

Price requests for customized products or special items can be submitted via the ["Member Zone"](#) section of our website, at www.logiflex.ca. Our quotations department will study your request and send you a quotation and a technical drawing for approval as soon as possible. Modifications to quotations or technical drawings can be requested the same way. The approved quotation(s) and technical drawing(s) can then be attached to your purchase order.

Orders

An official purchase order must be issued for all purchases. Your

purchase order must contain the following information:

- Your company letterhead
- Your reference number
- The delivery address (with contact name, email and phone number)
- The complete product codes
- Furniture colour(s)
- Quantities
- Descriptions
- Retail prices and net prices
- Project registration number (if applicable), and your approved quotation and technical drawing (for special items).

Please note that a quotation cannot serve as a purchase order.

Returns

All returns must first be approved by Logiflex. If the return is accepted, a Logiflex customer service representative will send you an official return authorization form in order to facilitate procedures between you, the carrier, and the Logiflex merchandise reception clerk. Additional costs for shipping or other expenses may be applied following any merchandise returns.

Modifications and/or Cancellations

You have 48 hours from the time we acknowledge receipt of your order to make any requests for corrections or modifications. You may cancel your order during this same 48-hour period. If you would like to modify or cancel your order after this 48-hour verification period, please check with a Logiflex customer service representative. Orders cannot be changed or cancelled if production has already begun or if Logiflex has already received the raw materials.

Liability

Logiflex's liability ends once the carrier has delivered all items in good condition. A delivery receipt signed by the customer acknowledges that the shipment is complete and has been received in good condition.

Claims

Logiflex recommends inspecting the shipment before signing the carrier's delivery receipt. You must notify Logiflex of any incomplete shipments or damaged furniture within 30 days after delivery. Requests to replace damaged products can be made via the ["Member Zone"](#) section of our website, at www.logiflex.ca. Our after-sales service department will examine your request and help you correct the situation.

Changes

Logiflex reserves the right to make changes to the materials, accessories, components, specifications and designs, and to discontinue collections and/or models, at any time and without prior notice.

Storage and/or Shipping Fees

According to the terms Logiflex set forth in the transport policy. The transport policy can be consulted online in the Private Space.

Warranty

Logiflex guarantees to the original purchaser that Logiflex products are free from defects in design, materials and workmanship for the product's lifetime, with certain exceptions.

You may consult the full warranty on the website:

[Logiflex Warranty](#)

Introduction

How to Use the Price List

Interactive Menu

Product line

Product group

Product name

Product code

Product image

Product Information

Illustrated options

Navigation Buttons (when blue)

Ordering instructions

Navigation buttons

- Previous View
- Previous Page
- Next Page
- Product Map
- Table of Contents

Product-specific manufacturing standards

Additional Product Information and Notes

Product Code

Prices

Blue text hyperlink

Standard Product Code Details as per the price listed

Options, if desired (\$) Always after the product code

Combination of Colors Laminate finishes and fabric choices

Modular Seating

SIT - Corner Bench with Back

CBD **CBM** **CBH**

Corner bench with short back Corner bench with medium back Corner bench with high back

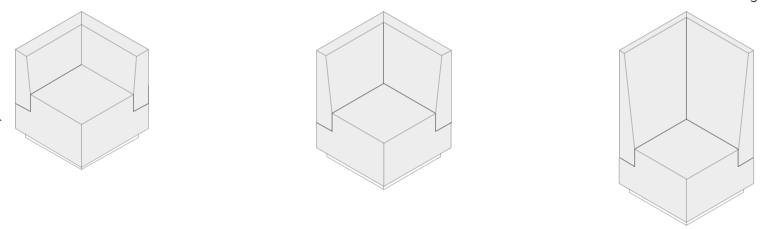

Combination of Colors

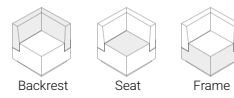

Manufacturing Standards

- Lacquered Russian plywood kick plate;
- 1" laminate construction;
- Firm density antibacterial foam;
- Single row of top stitching.

Kick Plate: Offered in the following 4 colors: Polar White, Mink Grey, Slate and Jet Black.

COM Fabrics: COM Fabrics are provided by the customer. For pricing please refer GR2 grade price.

Dimensions:

Code	Total width	Total depth	Total height
CBD	26.25"	26.25"	29"
CBM	26.25"	26.25"	36"
CBH	26.25"	26.25"	48"

Number of yards for COM fabric: [See Appendix B](#)

Code	Total	Backrest	Seat	Frame
CBD	4.5	2.75	.75	1.25
CBM	5.25	3	.75	1.25
CBH	6.25	4.5	.75	1.25

Note: It is recommend that you include a layout with all orders and that you choose a solid fabric color for the seat portion.

Options

Connectivity **Connectivity Position**

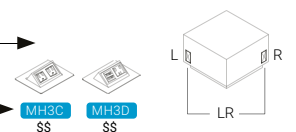

Prices

Code	GRA	GR1	GR2	GR3	GR4	GR5	GR6	GR7	GR8	GR9	GR10	GR11	GR12	Cuir Leather
CBD	****	****	****	****	****	****	****	****	****	****	****	****	****	****
CBM	****	****	****	****	****	****	****	****	****	****	****	****	****	****
CBH	****	****	****	****	****	****	****	****	****	****	****	****	****	****

How to Order

Combination of Colors

SIT	CBD	CBM	CBH	MH3C	MH3D	L	R	LR	Finishes	Fabric		
series	code	code	code	connectivity	connectivity	position	position	position	kick plate	supplier	pattern	color
Example	SIT	CBD		MH3C		L			W	ENNIS	LOFT	AQUA

Introduction



Appendix A: Colors and Finishes

How to specify your laminate colors

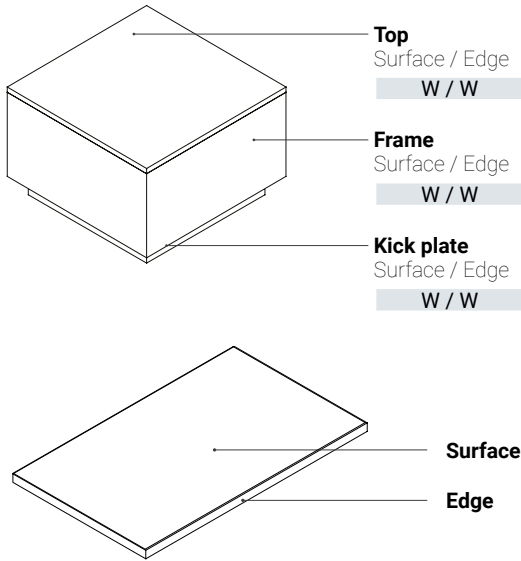

The edge is always the same color as the laminate surface color.

SIT Stretching Upholstery

To know which fabrics have been approved to be used in the SIT collection, refer to our [Upholstery Guide](#).

Availability Chart

FINI FINISH	CODE	COLOR COULEUR	THICKNESS ÉPAISSEUR			HPL	PANVAL CODE
			5/8"	1"	1-5/8"		
OMNIA	DOO	Dosha	•	•		•	K77
	COO	Cosmos	•	•		•	K78
AURA	GIA	Ginger Root Gingembre	•	•		•	H72
	HAA	Haze Brume	•	•	•	•	H57
	OHA	Ohm	•	•	•	•	K69
	STA	Storm Tempête	•	•	•	•	H58
	TUA	Tundra	•	•		•	H75
LYRA	ASY	Asha	•	•		•	K47
	CIY	Chiffon Mousseline **	•	•	•	•	K60
	KAY	Kali	•	•		•	K46
SUPERMAT	IGS	Ingot grey Gris lingot	•	•			828
	WGS	Willow grey Gris saule	•	•			802
DOLOMITE	AU	Audacity Audace **	•	•	•	•	241
	B	Jet Black Noir intense *	•	•		•	888 S405-CA
	BC	Brown cherry Cerisier brun	•	•	•	•	207
	C	Slate Ardoise *	•	•		•	801
	DR	Driftwood Bois de rive	•	•		•	744
	G	Mink Grey Gris vison	•	•		•	805 OU-927
	NM	Natural Maple Érable naturel	•	•	•	•	206
	PO	Porto	•	•		•	913 OU-648
	SW	Smoked Walnut Noyer fumé	•	•	•	•	G21
	TO	Tobacco	•	•		•	205
	W	Polar White Blanc polaire	•	•	•	•	555 459-CA
	WK	Whisky	•	•	•	•	245

* Non recommended color for work surfaces.

** For conference tables with 2 or more parts, we do not recommend the use of colors with irregular and contrasted woodgrain like Chiffon, Audacity or Coastal Pear as it results in a pronounced wood grain mismatch.

Colors may vary from 2% to 5% between tfl and hpl laminates due to different technical applications.

See our complete [Colors & Finishes Guide](#)

New



Appendix A: Colors and Finishes

12 Wood Stains

Logiflex offers varnish and stain selection among the following 12 colors on all wood applications. The selection available may vary depending on the collections: please refer to the product pages for the selection available by collection. For example, the wooden Madrid chair is only available in Golden Wheat.

Knots and color variation can occur between different wood components of the same piece of furniture, or between different pieces of furniture. This variation is due to the natural characteristics of the wood, and is more contrasting for pale wood colors like Golden Wheat.



WW White Wash



GW Golden Wheat



SD Sand

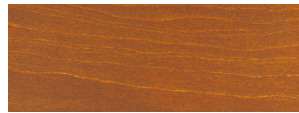

AT Apricot

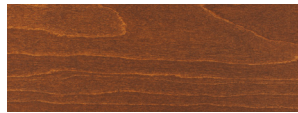

PN Pecan

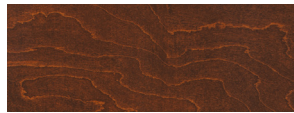

BR Brandy

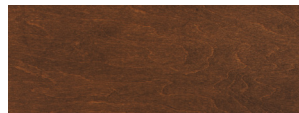

CT Chestnut

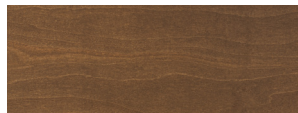

CF Coffee

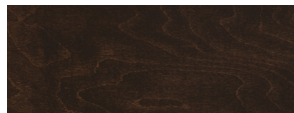

ES Espresso



BO Bordeaux

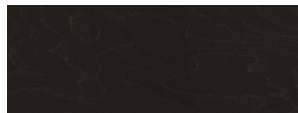

BW Black Wash

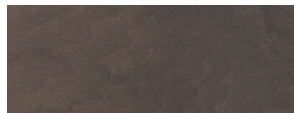

BK Bark

2 Plastic Stains

A choice of 2 colors for the Stack6 chair. [p. 92](#)

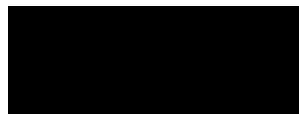

01 Black



10 Charcoal

12 Strap Colors

A choice of 12 colors for the Leo Flow - interactive [p. 53](#)



H01 Black

BLACK



H02 Coal

Pantone 447 U



H03 Grey

Pantone 7535 U



H04 Red

RED 032 U



H05 Orange

ORANGE 021 U



H06 Yellow

Pantone 106 U



H07 Blue

Pantone 2935 U



H08 Navy

Pantone 540 U

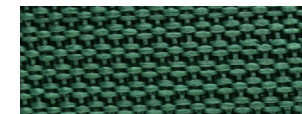

H09 Green

Pantone 342 U

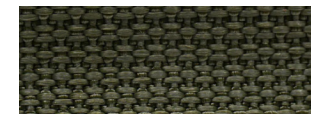

H10 Olive

Pantone 7764 U

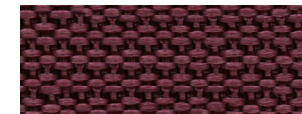

H11 Burgundy Pantone 7421 U



H12 Tan

Pantone 2310 U



Appendix B: Upholstery Specification

Logiflex offers two options for upholstery specification:

Option 1 :	Customers may specify an upholstery from any supplier. Logiflex will then confirm upholstery grade and seat cost.
Option 2 :	Customers may select and purchase upholstery of their choice and ship upholstery to Logiflex (COM)

Option 1 : Specified Upholstery

Customers may consult the websites of our principal suppliers to visualize their complete product range. It is then possible to consult the graded-in list available on Logiflex.ca to be informed of the appropriate Logiflex grade.

Website of the upholstery supplier gives essential information to the maintenance, availability, quality and performance of the selected upholstery. In all cases, the upholstery supplier's warranty will apply.

Information to provide with the order:

Customer name
Purchase order number
Upholstery supplier name
Pattern name/number
Color name/number
Number of yards to order

Principal suppliers:

Momentum Textiles	themomgroup.com
Ennis Fabrics	ennisfabrics.com
Maharam	maharam.com
Designtex	designtex
Mayer Fabrics	mayerfabrics.com

See our Graded-In Program at:

logiflex.ca/medias/documents/logiflex-graded-in.pdf

Graded-in List:

Seat cost depends of selected upholstery. Grade is not established according to upholstery quality or performance, but to its purchase cost. In order to help customers researches, a graded-in list presenting the entire collections of Logiflex's principal suppliers has been prepared. It is possible to consult Logiflex graded-in list by visiting logiflex.ca

Note: The graded-in list is based on information at time of the publication of this document. As upholstery suppliers can discontinue products or increase their prices at their discretion, this list communicated for information purposes only and can not be considered as a sale commitment by Logiflex.

Option 2 : Customer's Own Material (COM)

Logiflex offers the option of providing your own upholstery. The price will be based on the cushion grade 2.

Orders with a COM fabric must be written clearly and indicate the color, pattern, width of the fabric and the manufacturer or distributor. The customer is responsible for providing a 12" x 12" sample to Logiflex for approval of the upholstery and the COM Fabric Sample - Approval Form. Furthermore, Logiflex reserves the right to refuse any upholstery that does not meet Logiflex selection criteria.

COM fabrics must be delivered to the Logiflex factory with freight and duties paid. For COM orders, the order's delivery date is set once Logiflex has received all fabric rolls required for production, following sample approval. All charges to COM acquisition on the customer's behalf will be passed onto the customer.

Logiflex does not assume responsibility for upholstery availability, quality, performance or appearance. In addition, the Logiflex warranty excludes customer's own materials.

Consult Logiflex's [Upholstery Guide](#) for more details.

COM upholstery delivery:

The following information must be included with the COM upholstery delivery and be communicated to the account manager along with the purchase order:

Customer name
Purchase order number
Upholstery supplier name
Pattern name/number
Color name/number
Number of yards delivered

[COM Fabric Sample - Approval Form](#)

Shipping address:

Logiflex
Attn: Receiver
1235 St-Roch North Road
Sherbrooke Quebec
Canada J1N 0H2

Note: A late reception of fabric may cause delivery delays.

Upholstery Quantities:

The quantities of fabric yardage to order for each piece of furniture is indicated in the "Manufacturing Standard" section on the product page indicating the amount of yards required.

Where this option is available, you will see the following table in the "Manufacturing Standard" section on the product page indicating the amount of yards required:

Example:

Number of yards for COM fabric:

Code	Total	Back	Seat	Frame
BD	3.25	1.25	2	1.25
BM	3.5	1.75	2	1.25
BH	4	2.25	2	1.25

Note: It is recommend that you include a layout with all orders and that you choose a solid fabric color for the seat portion.



Appendix B: Upholstery Specification *(continued)*

Seams

Different top stitchings are available for different armchair models.

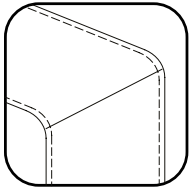

PQS

Single Top Stitch

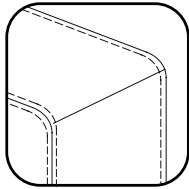

PQD

Double Top
Stitch

Combining Fabrics

Different fabrics can be specified for the bench and back of the same seat at no extra cost.

Where this option is available, you will see the **Combination of Colors** indicator illustrations.

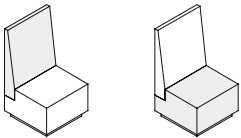

Example:

Backrest: ENNIS / BALANCE / #9009 GR1

Seat: ENNIS / ORNAMENTAL / #302 GR3

The price will be that of the highest-grade fabric chosen.

Application of Upholstery

Application of upholstery will follow the directional orientation of its pattern. Explicit instructions must be given to the customer's account manager if a specific direction is desired. Logiflex will not be responsible of problems related to upholstery direction or positioning unless formal instructions has been given along with the purchase order.

Instruction references:

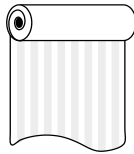

Up the Roll

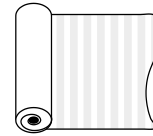

Railroaded
(across the roll)

Leather

All leathers used are "cowhide".

Please note that the warranty does not apply on leather's natural imperfections, such as: scars, marks, and difference in stain within a leather skin or different skins. This specification also applies for standard leather GR5 and Italian leather GR7 and up.

Polyurethane foam

The polyurethane foam used in the manufacturing of our armchairs is antibacterial.

Different densities exist and will vary from one armchair model to the other. Medium-density foam is used for back and seating parts, while the firmer-density foam is used for armrest parts.

CAL 117 Flammability standards

The foam used meets or exceeds the flammability standards of the California Technical Bulletin 117 norms.

CAL 133 Flammability standards

It is possible to order chairs or soft seating that comply with the technical bulletin California 133 (CAL 133) used primarily in public buildings without sprinkler systems. In order to be compliant, the fabrics must be certified CAL 117 and a fire blocking material, which prevents fire from spreading, must be installed under the fabric by Logiflex.

To obtain a certificate from an independent laboratory, you must pay the price of the compliant product to be tested plus a cost to cover the transportation, testing and the issuing of the certificate

Customers interested in ordering a CAL 133 compliant product are encouraged to contact customer service for pricing and instructions.

Introduction



Appendix C : SIT

Manufacturing Standards

Levelers

All modules with a kick plate sit on white nylon levelers.

Fasteners

All modules with a kick plate can be joined to other modules with a fastener (not included), see [p. 138](#).

Dimensions

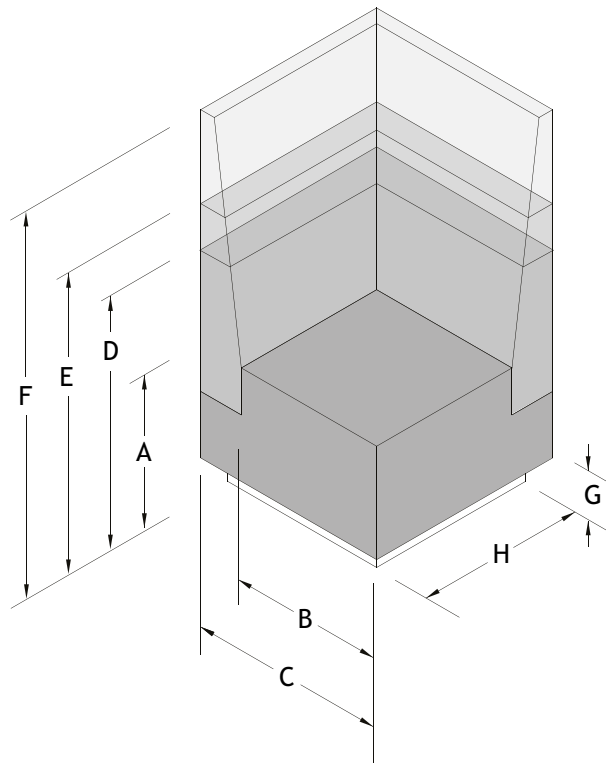

	A. Bench height	18" *
	B. Bench depth to back	20-3/4" *
	C. Bench depth to panel	26-3/4" *
	D. Short back height	29"
	E. Medium back height	36"
	F. High back height	48"
	G. Kick plate height	3-1/2"
	H. Kick plate width	22"

* Dimensions may vary depending on selected fabric thickness.

Wiring Management

All kick plates include a half-round machine-cut on all four sides for feeding cables from one module to the next.

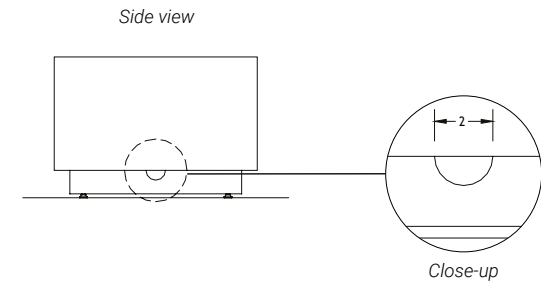

Installation example

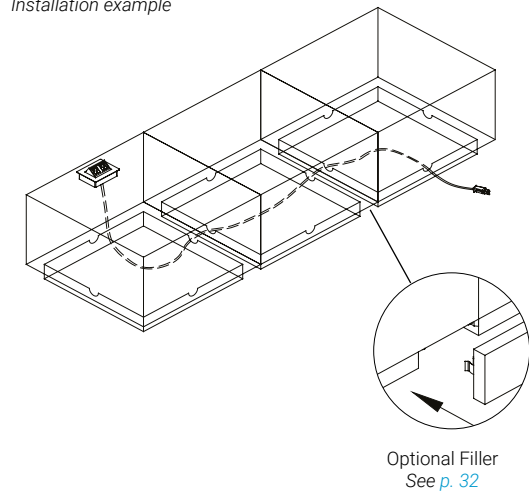

Introduction



Appendix C : SIT

MH3 - Connectivity - positions

Benches and tables

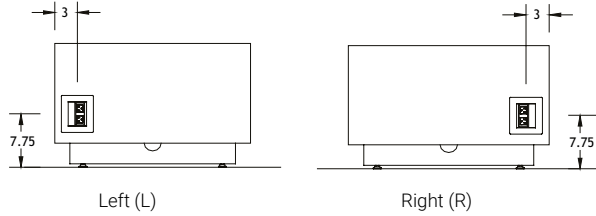

Benches with notch(es)

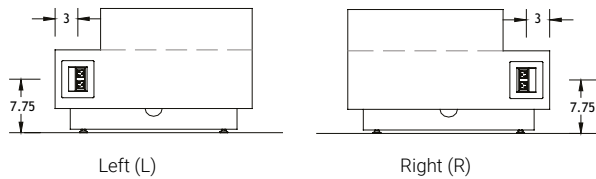
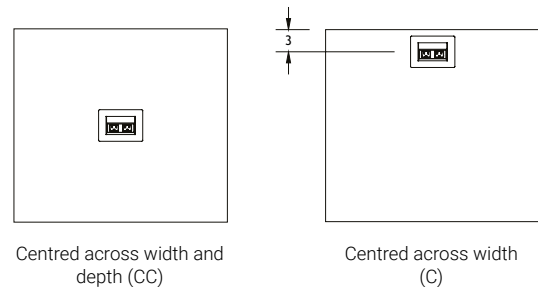
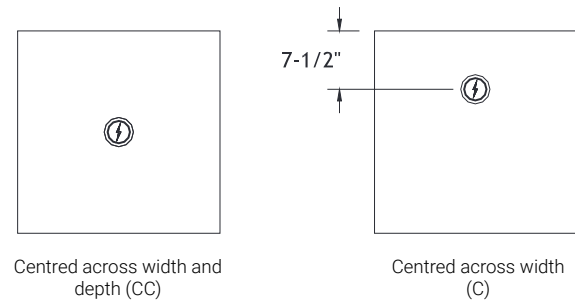

Table tops



Qi - Connectivity - positions



Appendix D : Kick plate Colors

Logiflex offers a selection among the following colors for the SIT collection kick plates:



C Slate

B Jet Black

Appendix E : Wood Color Selection

Logiflex offers varnish and stain selection among the following colors:

- GW** Golden Wheat
- WW** White Wash
- CT** Chestnut
- ES** Espresso
- AT** Apricot
- BW** Black Wash
- PN** Pecan
- CF** Coffee
- BR** Brandy
- BK** Bark
- SD** Sand
- BO** Bordeaux

* Madrid chairs are only available in Golden Wheat (GW)



Appendix F : Backs/Seats Options for Chairs

Seat Width

Available for chairs:

Width	Cyrus	Texto	Texto Mesh	Texto Lab	Elie
Narrow seat		TX1			
Standard seat		TX2	TXM2		
Large seat		TX3	TXM3		

● Not available for chairs with stool height.

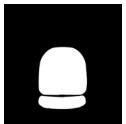

- 1 Narrow seat (-2")**
- Width seat: 17"
 - Width backrest: 16 1/2"
 - Depth seat: 17"



- 2 Standard seat**
- Width seat: 19"
 - Width backrest: 18 1/2"
 - Depth seat: 18"

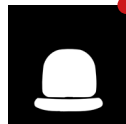

- 3 Large seat (+2")**
- Width seat: 21"
 - Width backrest: 18 1/2"
 - Depth seat: 18"
 - "Heavy duty" type cylinder with a thrust of 450 Newton.
 - Reinforced fixing of the backrest bar to the structure.
- \$155

Back Height

Available for chairs:

Height	Cyrus	Texto	Texto Mesh	Texto Lab	Elie
L - Low		o		o	
M - Medium		o			o
D - Director		o			
H - High		o			o
T - T Shaped back				o	
C - Contour back				o	
X - No back				o	

*For backrest heights, see product pages



L Low back

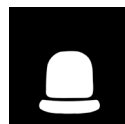

M Medium back



D Director back



H High back with headrest



T T shaped back



C Contour back



X No back



Appendix G : Base Options for Chairs

Chairs Options

Available for chairs:

Code	Cyrus	Texto	Texto Mesh	Texto Lab	Elie
VN	o	o	o		o
ZN	o	o	o	o	o
VC	o	o	o		o
ZC	o	o	o	o	o
TN		o	o	o	
TC		o	o	o	
01	o	o	o		o



VN Black nylon tapered base
 • 27" diameter



ZN Black nylon rounded base
 • 27" diameter

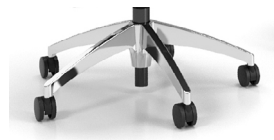

VC Aluminum tapered base
 • 27" diameter
 \$174



ZC Aluminum rounded base
 • 27" diameter
 \$174



TN Black nylon rounded stool base
 • 27" diameter
 • 10 5/8" cylinder
 • 60° footrest, 20" diameter
 • Height-adjustable



TC Aluminum rounded stool base
 • 27" diameter
 • 10 5/8" cylinder
 • 360° footrest, 20" diameter
 • Height-adjustable
 \$174



01 Sled base

● **Cylinders :**

18 - Seat height between 16" - 21", recommended with a work surface height of 30".

24 - Seat height between 18" - 25,5", recommended with a work surface height of 36".

30 - Seat height between 22" - 32", recommended with a work surface height of 42".

Appendix H : Mechanism Options for Chairs

Mechanisms

Available for chairs:

Code	Cyrus	Texto	Texto Mesh	Texto Lab	Elie
10		o	o		o
11		o	o	o	o
20		o	o		o
21		o	o		o
31		o	o	o	o
41	o	o	o		o
51		o	o	o	o
71		o	o		
76F		o			

* Mechanisms 31 and 51 for stools: the tilt function is not included for safety reasons. Only the mechanism 51 allows adjustment of the seat angle.



Mechanism 10

- Adjustable height (screw)
- 360° swivel on column axis



Mechanism 11 13

- Adjustable height (gas cylinder)
- 360° swivel on column axis



Mechanism 31

- Adjustable height (gas cylinder)
- 360° swivel on column axis
- Backward tilt from 3° to 18° (center pivot)
- Adjustable tilt tension
- Tilt lock to one position, at 3°
- Adjustable angle on back from 86° to 121°

\$30



Mechanism 41S

- Adjustable height (gas cylinder)
- 360° swivel on column axis
- Synchro tilt of seat from -1° to 10° (center pivot) and of back from 90° to 110°
- Adjustable tilt tension
- Tilt lock in 5 positions
- Adjustable depthseat of 2-1/2"
- Compatible with option F

\$60



Mechanism 20

- Adjustable height (screw)
- 360° swivel on column axis
- Tilt lock to one position, at 3°

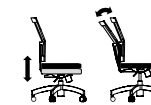

Mechanism 21

- Adjustable height (gas cylinder)
- 360° swivel on column axis
- Tilt lock to one position, at 3°
- Backward tilt from 3° to 20° (center pivot)



Mechanism 51

- Adjustable height (gas cylinder)
- 360° swivel on column axis
- Backward tilt from 3° to 17° (center pivot)
- Adjustable tilt tension
- Tilt lock in all positions
- Adjustable backrest angle from 80° to 108°

\$60



Mechanism 71

- 360° swivel on column axis.
- Adjustable height (gas cylinder)
- 20° backward tilt starting from initial position adjustable between -4° to 5°
- Adjustable tilt tension
- Tilt lock in all positions
- Adjustable backrest angle from 89° to 105°

\$126



Mechanism 76F

- Adjustable height (gas cylinder)
- 360° swivel on column axis
- 20° backward tilt starting from initial position adjustable between -4° to 5°
- Adjustable tilt tension
- Tilt lock in all positions
- Adjustable backrest angle from 89° to 105°
- Adjustable depthseat of 2-1/2"
- Adjustable backrest of 4"

\$176



Appendix I : Chairs Options

Options

Available for chairs:

Code	Cyrus	Texto	Texto Mesh	Texto Lab	Elie
R		o	o	o	
S		o	o		o
F		o			

R Back height adjustment option

This option allows a backrest adjustment of 3". The option is available on certain mechanisms only, add "R" after the mechanism code (ex. mechanism #21 becomes #21R).

\$35

S Seat sliding option

This option allows a front-to-back sliding seat adjustment of 2 ½", to adjust the seat depth. The option is available on certain mechanisms only, add "S" after the mechanism code (ex. mechanism #21 becomes #21S) and add \$72. Not available on X-Large seat widths.

\$87

F Combined options

Backrest height adjustment & sliding seat. The option is available on certain mechanisms only, add "F" after the mechanism code (ex. mechanism #21 becomes #21F) and add \$99. Not available on X-Large seat widths.

\$122

Introduction

Appendix J : Arms Options for Chairs

Arms

Available for chairs:

Code	Cyrus	Texto	Texto Mesh	Texto Lab	Elie
NA	o	o	o		o
AD	o	o	o		o
AG		o	o		
AP		o	o		
AR		o	o		
AS	o	o	o		o
AW		o	o		
AX		o	o		
AY		o	o		
AZ	o	o	o		o
FD	o	o	o		o
FG	o	o	o		o
FT		o	o		o
FZ	o	o	o		o
F7	o				
F61	o				

If the chair is not in the table, it means that it is compatible with all arms.

Texto visitor chair : validate the available arms in the product page.

No Arm



- NA**
- No arm

Adjustable Arms



AG \$150



AP \$150



AR \$150

Adjustable arms

- Black nylon arm, steel attachment with urethane armrest.
- Medium firmness (3/5).
- Height adjustment of 3" using a lever.
- 3" width adjustment.



AD \$150

Adjustable arms

- Black nylon arm, steel attachment with urethane armrest.
- Medium firmness (3/5).
- Height adjustment of 3" using a lever.



AX \$232

Adjustable arms with multi-axis armrests

- Black nylon arm, steel attachment with urethane armrest.
- Medium firmness (3/5).
- Height adjustment of 3" using a lever.
- 3" width adjustment.



AS \$150

Adjustable arms

- Black nylon arm, steel attachment with urethane armrest.
- Medium firmness (3/5).
- Height adjustment of 3" using a push button.



AY \$232

Adjustable arms with multi-axis and pivot armrests

- Black nylon arm, steel attachment with urethane armrest.
- Medium firmness (3/5).
- Height adjustment of 3" using a lever.
- Lateral and front-to-back armrest adjustment.
- Pivot of -30° to +30°.
- 3" width adjustment on certain models.



AW \$150

Adjustable arms with pivot

- Black nylon arm, steel attachment with urethane armrest.
- Medium firmness (3/5).
- Height adjustment of 3" using a lever.
- Pivot of -30° to +30°.
- 3" width adjustment.



AZ \$307

Adjustable arms with multi-axis and pivot armrests

- Black nylon arm, polished aluminum attachment with urethane armrest.
- Medium firmness (3/5).
- Height adjustment of 2 3/4" using a push button.
- Pivot of -30° to +30°.
- Front/back adjustment of 2".



Appendix J : Arms Options for Chairs

Fixed Arms



FD \$150



FG \$150

Open/Closed fixed arms

- Reinforced steel frame covered in urethane.
- Medium firmness (4/5).
- 3" width adjustment on certain models.



FT \$150

Open curved fixed arms

- Reinforced steel frame covered in urethane.
- Medium firmness (3/5).
- 3" width adjustment on certain models



FZ \$307

Fixed arms

- Polished aluminum frame arm.
- Medium firmness (4/5).
- Armrest upholstered with the same fabric as the chair.
- Not adjustable.



F7 \$307

Fixed aluminum arms

- Black polyurethane cover



F61 \$150

Fixed T shaped arm

- Black polyurethane pad



Appendix K : Legs Chairs Options

Legs

Available for chairs:

Code	Cyrus	Texto	Texto Mesh	Texto Lab	Elie	Madrid
H	<input type="radio"/>	<input type="radio"/>	<input type="radio"/>	<input type="radio"/>	<input type="radio"/>	
S	<input type="radio"/>	<input type="radio"/>	<input type="radio"/>	<input type="radio"/>	<input type="radio"/>	
G	<input type="radio"/>	<input type="radio"/>	<input type="radio"/>	<input type="radio"/>	<input type="radio"/>	
M		<input type="radio"/>	<input type="radio"/>	<input type="radio"/>		
T						<input type="radio"/>



H Casters for carpeting

- Lightly textured black nylon.
- 2" diameter with double drum.
- For VN and VC bases, the caster has a 2 3/8" diameter.



M Mixed (3 casters, 2 glides)

- For 5-prong bases for stools (TN, TC and TB) (Texto with stool and Texto Lab), a mixed option can be specified: 3 "H" casters and 2 "G" glides will be installed on the base.



S Casters for hard surfaces

- Lightly textured black nylon.
- 2" diameter with double drum.
- The center of the caster is nylon covered in ultra-soft urethane for a smoother rolling motion.
- For VN and VC bases, the caster has a 2 3/8" diameter

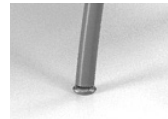

T Teflon glides



G Nylon glides

- Lightly textured black nylon.
- 2" high.
- On VN and VC bases, the glide is 2 3/8" high.

Introduction



Appendix L : Leo Flow Heights

Leo Flow Heights

Comparisons of different heights for the Leo Flow.

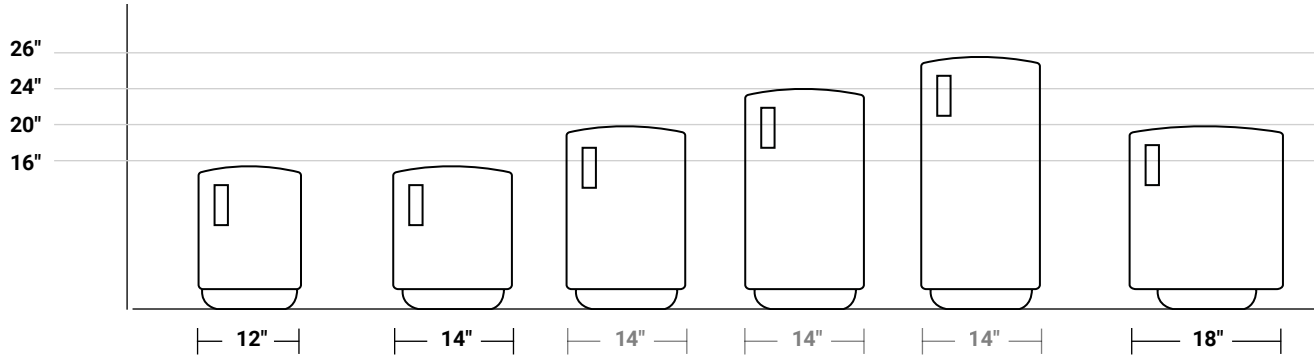

Leo Flow and Surfaces

Examples of the different heights of the Leo Flow with different surface heights.

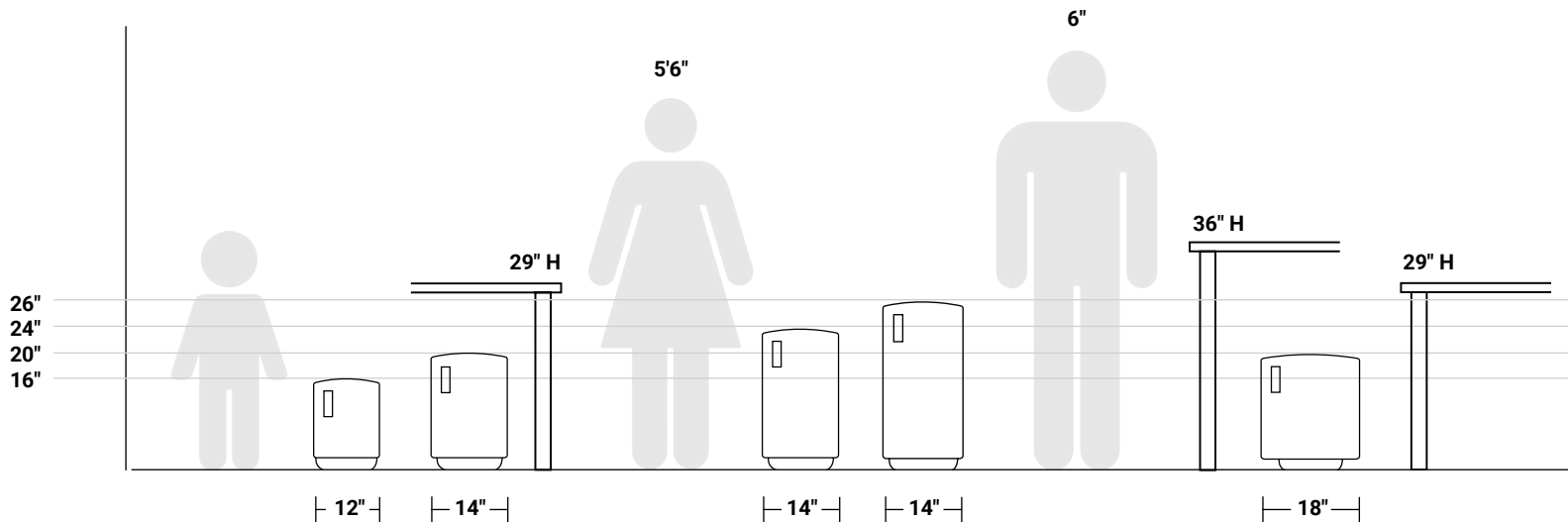

Modular Seating

SIT - Bench

B

Bench with kick plate

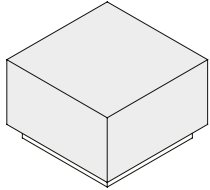

Manufacturing Standards

- Lacquered Russian plywood kick plate;
- 1" laminate construction;
- Firm density antibacterial foam;
- Single row of top stitching.

Kick Plate: Offered in the following 2 colors: Slate and Jet Black.

COM Fabrics: COM Fabrics are provided by the customer. For pricing please refer GR2 grade price.

Dimensions:

Code	Total width	Total depth	Total height
B	26.25"	26.25"	18"

Number of yards for COM fabric:

[See Appendix B](#)

Code	Total
B	2,5

Note: It is recommend that you include a layout with all orders.

Options

Connectivity



\$449

Connectivity Position

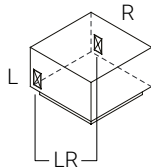

Prices

Code	GRA	GR1	GR2	GR3	GR4	GR5	GR6	GR7	GR8	GR9	GR10	GR11	GR12	Cuir Leather
B	1141	1172	1214	1256	1307	1360	1411	1465	1516	1569	1620	1724	1828	1742

How to Order

										Fabric				
										MH3DSN	L	R	LR	
										MH3DBL				
										MH3DWH				
										See the Logiflex Graded-in List				
										Finishes				
LL	-	SIT	-	B	-		-							
		serie			code	kick plate		supplier	pattern	color	connectivity		position	
Example	LL	-	SIT	-	B	-	B	-	ENNIS	LOFT	AQUA	-	MH3DSN	L

Modular Seating

SIT - Bench with Back

BD

Bench with short back

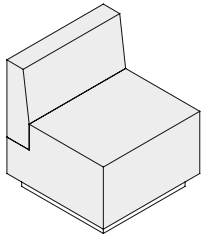

BM

Bench with medium back

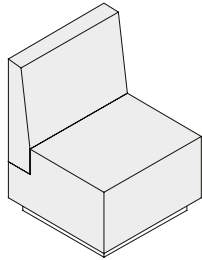

BH

Bench with high back

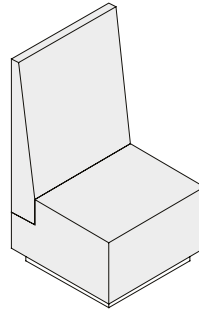

Manufacturing Standards

- Lacquered Russian plywood kick plate;
- 1" laminate construction;
- Firm density antibacterial foam;
- Single row of top stitching.

Kick Plate: Offered in the following 2 colors: Slate and Jet Black.

COM Fabrics: COM Fabrics are provided by the customer. For pricing please refer GR2 grade price.

Dimensions:

Code	Total width	Total depth	Total height
BD	26.25"	26.25"	29"
BM	26.25"	26.25"	36"
BH	26.25"	26.25"	48"

Number of yards for COM fabric:

[See Appendix B](#)

Code	Total (1 fabric)	Seat	Backrest
BD	5	2,5	2,75
BM	5,75	2,5	3,25
BH	7	2,5	4,75

Note: It is recommend that you include a layout with all orders and that you choose a solid fabric color for the seat portion.

Combination of Colors

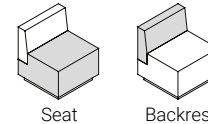

Options

Connectivity



\$449

Connectivity Position

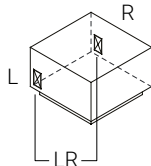

Prices

Code	GRA	GR1	GR2	GR3	GR4	GR5	GR6	GR7	GR8	GR9	GR10	GR11	GR12	Cuir Leather
BD	1605	1663	1742	1818	1915	2012	2107	2205	2301	2398	2495	2687	2881	2720
BM	1668	1730	1814	1897	2001	2105	2209	2313	2417	2522	2625	2834	3043	2869
BH	1771	1842	1937	2032	2151	2270	2389	2508	2627	2746	2864	3102	3340	3143

How to Order

										Fabric 1 (seat) <i>See the Logiflex Graded-in List</i>			Fabric 2 (backrest) <i>See the Logiflex Graded-in List</i>			MH3DSN MH3DBL MH3DWH	L R LR		
LL	-	SIT	-	BD BM BH	-	Finis	-	-	-	-	-	-	-	-	-	-	-	-	
serie		code		kick plate		fournisseur		patron		couleur		fournisseur		patron		couleur		connectivity	position
Example	LL	-	SIT	-	BD	-	B	-	ENNIS	LOFT	AQUA	-	ENNIS	LOFT	AQUA	-	MH3DSN	L	

Modular Seating

SIT - Corner Bench with Back

CBD

Corner bench with short back

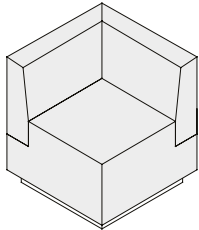

CBM

Corner bench with medium back

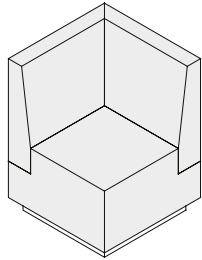

CBH

Corner bench with high back

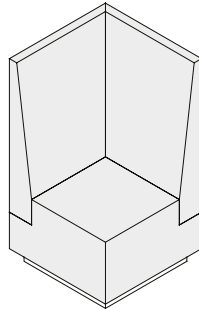

Manufacturing Standards

- Lacquered Russian plywood kick plate;
- 1" laminate construction;
- Firm density antibacterial foam;
- Single row of top stitching.

Kick Plate: Offered in the following 2 colors: Slate and Jet Black.

COM Fabrics: COM Fabrics are provided by the customer. For pricing please refer GR2 grade price.

Dimensions:

Code	Total width	Total depth	Total height
CBD	26.25"	26.25"	29"
CBM	26.25"	26.25"	36"
CBH	26.25"	26.25"	48"

Number of yards for COM fabric:

[See Appendix B](#)

Code	Total (1 fabric)	Seat	Backrest
CBD	4	2	2,5
CBM	4,5	2	3,25
CBH	5,75	2	4,5

Note: It is recommend that you include a layout with all orders and that you choose a solid fabric color for the seat portion.

Combination of Colors

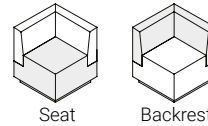

Options

Connectivity



\$449

Connectivity Position

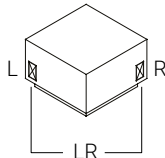

Prices

Code	GRA	GR1	GR2	GR3	GR4	GR5	GR6	GR7	GR8	GR9	GR10	GR11	GR12	Cuir Leather
CBD	1939	2019	2126	2233	2367	2502	2635	2769	2903	3036	3170	3438	3705	3482
CBM	2351	2445	2571	2696	2851	3008	3163	3321	3476	3632	3788	4100	4413	4153
CBH	2653	2765	2914	3062	3248	3434	3619	3806	3991	4177	4363	4735	5107	4797

How to Order

				CBD CBM CBH	Finis	Fabric 1 (seat) <i>See the Logiflex Graded-in List</i>			Fabric 2 (backrest) <i>See the Logiflex Graded-in List</i>			MH3DSN MH3DBL MH3DWH	L R LR					
	LL	-	SIT	-	-	-	-	-	-	-	-	-	-	-				
	serie	code	kick plate	fournisseur	patron	couleur	fournisseur	patron	couleur	connectivity	position							
Example	LL	-	SIT	-	CBD	-	B	-	ENNIS	LOFT	AQUA	-	ENNIS	LOFT	AQUA	-	MH3DSN	L

Modular Seating

SIT - Occasional Table with Laminate Frame

T

Laminate frame

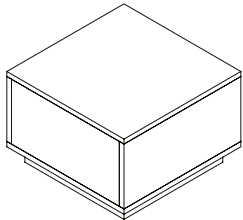

Combination of Colors

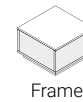
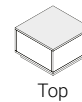

Manufacturing Standards

- 1" laminate top and frame;
- Lacquered Russian plywood kick plate;
- 1" laminate construction.

Kick Plate: Offered in the following 2 colors: Slate and Jet Black.

COM Fabrics: COM Fabrics are provided by the customer. For pricing please refer GR2 grade price.

Dimensions:

Code	Total width	Total depth	Total height
T	26.25"	26.25"	18"

Note: It is recommend that you include a layout with all orders.

Options

Marker Board

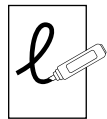

MB
\$268

Connectivity



\$449

Connectivity Position

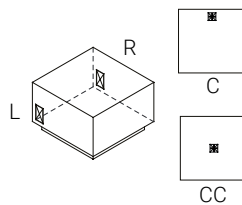

How to Order

														MH3DSN MH3DBL MH3DWH L R C CC		
														+		
														See the Logiflex Color Guide		
														MB		
OS	-	SIT	-	T	-	L1	-		-		-		-			
		serie		code		top		top		frame		kick plate		connectivity	position	
Example	OS	-	SIT	-	T	-	L1	-	W	-	W	-	B	-	MH3DSN	L

Modular Seating

SIT - Occasional Table with Fabric Frame

FT

Fabric frame

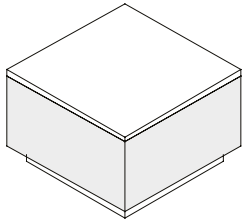

Combination of Colors
Laminate | Fabric

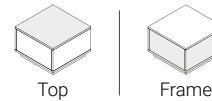

Manufacturing Standards

- 1" laminate top;
- Fabric frame
- Lacquered Russian plywood kick plate;
- 1" laminate construction.

Kick Plate: Offered in the following 2 colors: Slate and Jet Black.

COM Fabrics: COM Fabrics are provided by the customer. For pricing please refer GR2 grade price.

Dimensions:

Code	Total width	Total depth	Total height
FT	26.25"	26.25"	18"

Number of yards for COM fabric:

[See Appendix B](#)

Code	Total
FT	2

Note: It is recommend that you include a layout with all orders.

Options

Marker Board

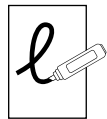

MB
\$268

Connectivity



\$449

Connectivity Position

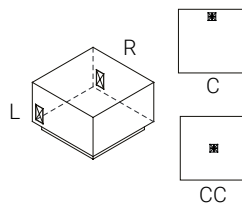

Prices

Code	GRA	GR1	GR2	GR3	GR4	GR5	GR6	GR7	GR8	GR9	GR10	GR11	GR12	Cuir Leather
FT	937	960	991	1020	1057	1095	1131	1169	1206	1242	1280	1354	1429	1367

How to Order

										Finis <i>Voir le guide de couleurs de Logiflex</i>			Fabric <i>See the Logiflex Graded-in List</i>			MH3DSN MH3DBL MH3DWH		L R C CC	
LL	-	SIT	-	FT	-	L1	-	-	-	-	-	-	-	-	-	-	-	-	
serie		code			top		top		kick plate		supplier		pattern		color		connectivity		position
Example	LL	-	SIT	-	FT	-	L1	-	W	-	B	-	ENNIS	LOFT	AQUA	-	MH3DSN	L	

Modular Seating

SIT - Bookshelf Tables with Laminate Frame

TB2

Open on 2 sides

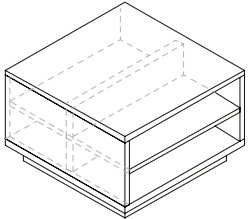

Combination of Colors

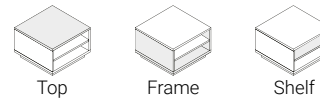

Manufacturing Standards

- 1" laminate top;
- Bookshelf with 1 fixed shelf per open side;
- Vertical central separator;
- Lacquered Russian plywood kick plate;
- 1" laminate construction.

Kick Plate: Offered in the following 2 colors: Slate and Jet Black.

Dimensions: [See Appendix B](#)

Code	Total width	Total depth	Total height
TB2	26.25"	26.25"	18"

Note: It is recommend that you include a layout with all orders.

Options

Marker Board



MB
\$268

Prices

Code	Price
TB2	935

How to Order

Finishes

[See the Logiflex Color Guide](#)

MB													
OS	-	SIT	-	TB2	-	L1	-		-		-		-
serie		code		top		top		frame		shelf		kick plate	

Example OS - SIT - TB2 - L1 - W - W - W - B

Modular Seating

SIT - Space Filler for Benches

FILLER4

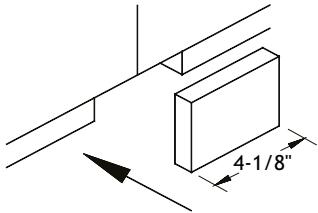

Manufacturing Standards

- 4-1/8" removable joint for junctions between kick plates;
- Lacquered Russian plywood.

Finishes: See [Appendix E](#).

Note: For best results, order 2 fillers for each module junction.

Prices

Code	
FILLER4	45

How to Order

FILLER4

code

Example FILLER4

Modular Seating

Infiniti - Square Bench

BC26

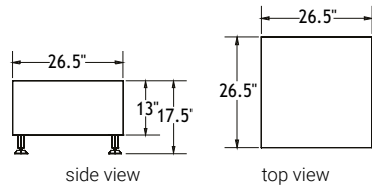
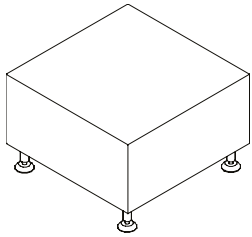

Manufacturing Standards

- 4 brushed chrome metal legs;
- Single top stitching;
- Elastic straps on seat;
- Firm density foam on seat;
- 1/2" thick polyester on the sides of the frame;
- Frame made out of plywood and hardwood..

COM Fabrics: COM Fabrics are provided by the customer. For pricing please refer GR2 grade price.

Number of yards for COM fabric: [See Appendix B](#)

Code	Total
BC26	1,75

Note: It is recommend that you include a layout with all orders and that you choose a solid fabric color for the seat portion.

Combination of Colors

Combination of different fabric colors available on quote request only.

Prices

Code	GRA	GR1	GR2	GR3	GR4	GR5	GR6	GR7	GR8	GR9	GR10	GR11	GR12	Cuir Leather
BC26	1131	1175	1235	1295	1369	1444	1517	1592	1667	1742	1815	1964	2113	1989

How to Order

Fabric
See the Logiflex Graded-in List

LL	-	IN	-	BC26	-			
serie		code		supplier	pattern	color		

Example LL - IN - BC26 - ENNIS LOFT AQUA

Modular Seating

Infiniti - Arched Bench

BA26

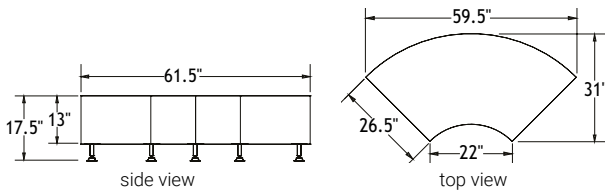
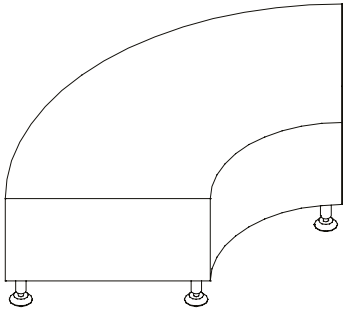

Manufacturing Standards

- 5 brushed chrome metal legs;
- Single top stitching;
- Elastic straps on seat;
- Firm density foam on seat;
- 1/2" thick polyester on the sides of the frame;
- Frame made out of plywood and hardwood..

COM Fabrics: COM Fabrics are provided by the customer. For pricing please refer GR2 grade price.

Number of yards for COM fabric: [See Appendix B](#)

Code	Total
BA26	2,75

Note: It is recommend that you include a layout with all orders and that you choose a solid fabric color for the seat portion.

Combination of Colors

Combination of different fabric colors available on quote request only.

Prices

Code	GRA	GR1	GR2	GR3	GR4	GR5	GR6	GR7	GR8	GR9	GR10	GR11	GR12	Cuir Leather
BA26	1836	1890	1962	2033	2123	2211	2301	2391	2480	2569	2658	2837	3015	2866

How to Order

Fabric
See the Logiflex Graded-in List

LL	-	IN	-	BA26	-			
serie		code		supplier	pattern	color		

Example LL - IN - BA26 - ENNIS LOFT AQUA

Modular Seating

Infiniti - Square Bench with Backrest

BCD26

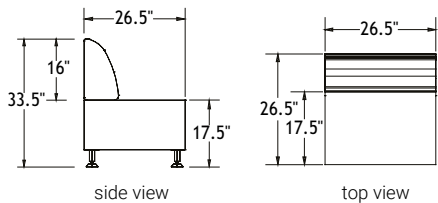
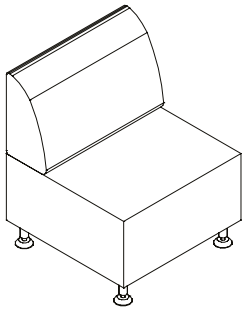

Combination of Colors

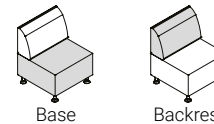

Manufacturing Standards

- 4 brushed chrome metal legs;
- Single top stitching;
- Elastic straps on seat and backrest;
- Firm density foam on seat and backrest;
- 1/2" thick polyester on the sides of the frame;
- Seat and backrest frames made out of recycled materials.

COM Fabrics: COM Fabrics are provided by the customer. For pricing please refer GR2 grade price.

Number of yards for COM fabric: [See Appendix B](#)

Code	Total	Base	Backrest
BCD26	3	1,75	1,25

Note: It is recommend that you include a layout with all orders and that you choose a solid fabric color for the seat portion.

Prices

Code	GRA	GR1	GR2	GR3	GR4	GR5	GR6	GR7	GR8	GR9	GR10	GR11	GR12	Cuir Leather
BCD26	1593	1656	1739	1822	1926	2031	2135	2239	2342	2447	2551	2759	2967	2793

How to Order

Fabric 1 (base)
[See the Logiflex Graded-in List](#)

Fabric 2 (backrest)
[See the Logiflex Graded-in List](#)

LL	-	IN	-	BCD26	-				-				
serie		code		supplier	pattern	color	supplier	pattern	color				

Example LL - IN - BCD26 - ENNIS LOFT AQUA - ENNIS LOFT AQUA

Modular Seating

Infiniti - Arched Bench with Inner Backrest

BADI26

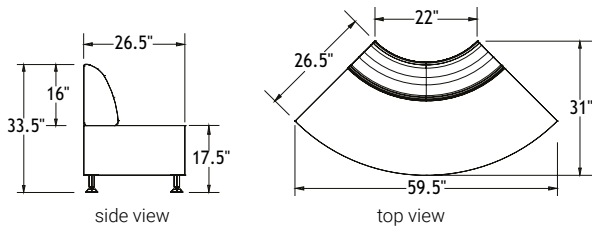
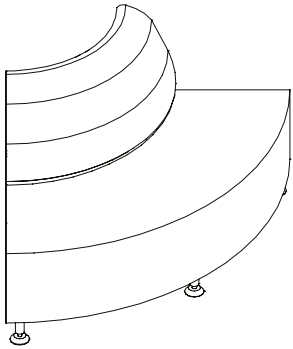

Manufacturing Standards

- 5 brushed chrome metal legs;
- Single top stitching;
- Elastic straps on seat and backrest;
- Firm density foam on seat and backrest;
- 1/2" thick polyester on the sides of the frame;
- Seat and backrest frames made out of recycled materials.

COM Fabrics: COM Fabrics are provided by the customer. For pricing please refer GR2 grade price.

Number of yards for COM fabric: [See Appendix B](#)

Code	Total	Base	Backrest
BADI26	4.25	2,75	1,5

Note: It is recommend that you include a layout with all orders and that you choose a solid fabric color for the seat portion.

Combination of Colors

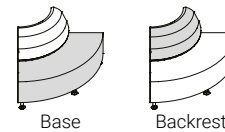

Prices

Code	GRA	GR1	GR2	GR3	GR4	GR5	GR6	GR7	GR8	GR9	GR10	GR11	GR12	Cuir Leather
BADI26	2509	2585	2686	2787	2914	3041	3166	3293	3419	3545	3672	3924	4178	3967

How to Order

Fabric 1 (base) [See the Logiflex Graded-in List](#) **Fabric 2 (backrest)** [See the Logiflex Graded-in List](#)

LL	-	IN	-	BADI26	-				-					
		serie	code		supplier			pattern	color			supplier	pattern	color

Example LL - IN - BADI26 - ENNIS LOFT AQUA - ENNIS LOFT AQUA

Modular Seating

Infiniti - Arched Bench with Outer Backrest

BADE26

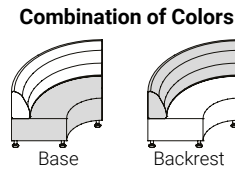
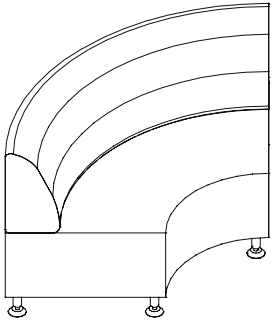

Manufacturing Standards

- 5 brushed chrome metal legs;
- Single top stitching;
- Elastic straps on seat and backrest;
- Firm density foam on seat and backrest;
- 1/2" thick polyester on the sides of the frame;
- Seat and backrest frames made out of recycled materials.

COM Fabrics: COM Fabrics are provided by the customer. For pricing please refer GR2 grade price.

Number of yards for COM fabric: [See Appendix B](#)

Code	Total	Base	Backrest
BADE26	5,25	2,75	2,5

Note: It is recommend that you include a layout with all orders and that you choose a solid fabric color for the seat portion.

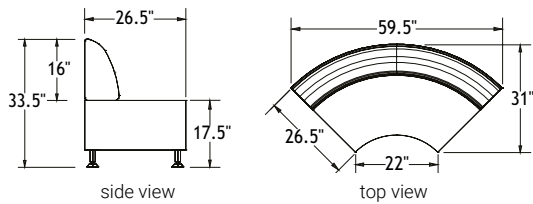

Prices

Code	GRA	GR1	GR2	GR3	GR4	GR5	GR6	GR7	GR8	GR9	GR10	GR11	GR12	Cuir Leather
BADE26	2666	2765	2895	3026	3189	3354	3517	3680	3844	4008	4172	4498	4826	4554

How to Order

Fabric 1 (base) [See the Logiflex Graded-in List](#) **Fabric 2 (backrest)** [See the Logiflex Graded-in List](#)

LL	-	IN	-	BADE26	-				-			
serie		code			supplier	pattern	color	supplier	pattern	color		

Example LL - IN - BADE26 - ENNIS LOFT AQUA - ENNIS LOFT AQUA

Modular Seating

Infiniti - Corner Bench with Backrest

BCCD26

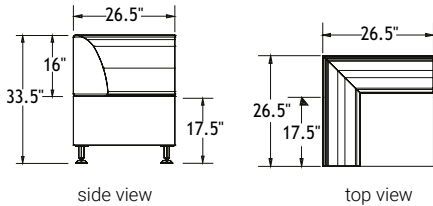
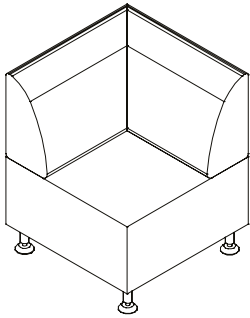

Combination of Colors

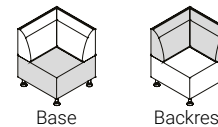

Manufacturing Standards

- 4 brushed chrome metal legs;
- Single top stitching;
- Elastic straps on seat and backrest;
- Firm density foam on seat and backrest;
- 1/2" thick polyester on the sides of the frame;
- Seat and backrest frames made out of recycled materials.

COM Fabrics: COM Fabrics are provided by the customer. For pricing please refer GR2 grade price.

Number of yards for COM fabric: [See Appendix B](#)

Code	Total	Base	Backrest
BCCD26	3,75	1,75	2

Note: It is recommend that you include a layout with all orders and that you choose a solid fabric color for the seat portion.

Prices

Code	GRA	GR1	GR2	GR3	GR4	GR5	GR6	GR7	GR8	GR9	GR10	GR11	GR12	Cuir Leather
BCCD26	1765	1855	1973	2093	2242	2391	2539	2687	2837	2985	3134	3432	3729	3480

How to Order

Fabric 1 (base)
See the Logiflex Graded-in List

Fabric 2 (backrest)
See the Logiflex Graded-in List

LL	-	IN	-	BCCD26	-				-			
serie		code		supplier	pattern	color	supplier	pattern	color			

Example LL - IN - BCCD26 - ENNIS LOFT AQUA - ENNIS LOFT AQUA

Modular Seating

Infiniti - Rectangular Bench

BC36

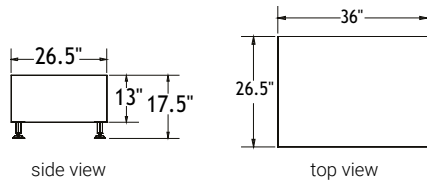
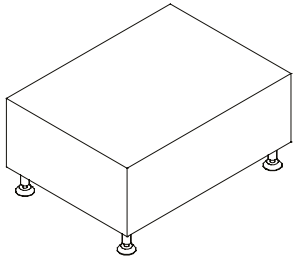

Manufacturing Standards

- 4 brushed chrome metal legs;
- Single top stitching;
- Elastic straps on seat;
- Firm density foam on seat;
- 1/2" thick polyester on the sides of the frame;
- Frame made out of plywood and hardwood..

COM Fabrics: COM Fabrics are provided by the customer. For pricing please refer GR2 grade price.

Number of yards for COM fabric: [See Appendix B](#)

Code	Total
BC36	2,25

Note: It is recommend that you include a layout with all orders and that you choose a solid fabric color for the seat portion.

Combination of Colors

Combination of different fabric colors available on quote request only.

Prices

Code	GRA	GR1	GR2	GR3	GR4	GR5	GR6	GR7	GR8	GR9	GR10	GR11	GR12	Cuir Leather
BC36	1152	1196	1256	1315	1389	1465	1538	1613	1687	1761	1835	1985	2133	2010

How to Order

Fabric
See the Logiflex Graded-in List

LL	-	IN	-	BC36	-			
		serie		code		supplier	pattern	color

Example LL - IN - BC36 - ENNIS LOFT AQUA

Modular Seating

Infiniti - Rectangular Bench with Backrest

BCD36

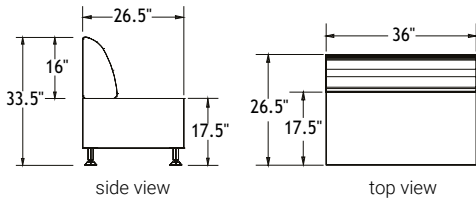
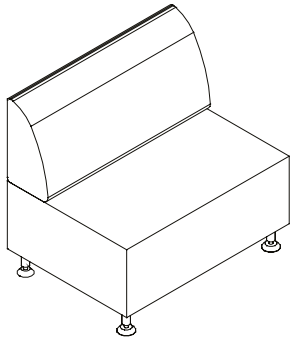

Combination of Colors

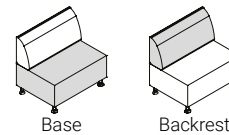

Manufacturing Standards

- 4 brushed chrome metal legs;
- Single top stitching;
- Elastic straps on seat and backrest;
- Firm density foam on seat and backrest;
- 1/2" thick polyester on the sides of the frame;
- Seat and backrest frames made out of recycled materials.

COM Fabrics: COM Fabrics are provided by the customer. For pricing please refer GR2 grade price.

Number of yards for COM fabric: [See Appendix B](#)

Code	Total	Base	Backrest
BCD36	3,75	2,25	1,5

Note: It is recommend that you include a layout with all orders and that you choose a solid fabric color for the seat portion.

Prices

Code	GRA	GR1	GR2	GR3	GR4	GR5	GR6	GR7	GR8	GR9	GR10	GR11	GR12	Cuir Leather
BCD36	1761	1829	1919	2007	2119	2230	2341	2453	2566	2677	2788	3011	3234	3049

How to Order

Fabric 1 (base)
[See the Logiflex Graded-in List](#)

Fabric 2 (backrest)
[See the Logiflex Graded-in List](#)

LL	-	IN	-	BCD36	-				-					
		serie	code		supplier			pattern	color			supplier	pattern	color

Example

LL	-	IN	-	BCD36	-	ENNIS	LOFT	AQUA	-	ENNIS	LOFT	AQUA
----	---	----	---	-------	---	-------	------	------	---	-------	------	------

Modular Seating

Infiniti - Rectangular Bench

BC48

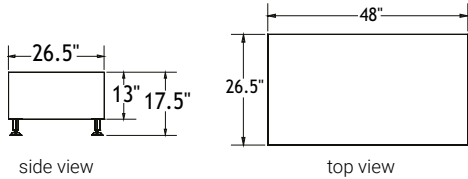
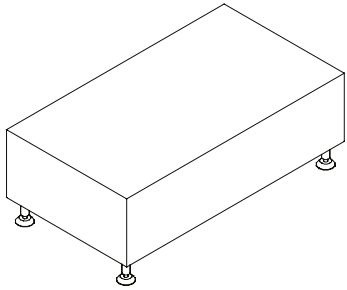

Manufacturing Standards

- 4 brushed chrome metal legs;
- Single top stitching;
- Elastic straps on seat;
- Firm density foam on seat;
- 1/2" thick polyester on the sides of the frame;
- Frame made out of plywood and hardwood..

COM Fabrics: COM Fabrics are provided by the customer. For pricing please refer GR2 grade price.

Number of yards for COM fabric: [See Appendix B](#)

Code	Total
BC48	3

Note: It is recommend that you include a layout with all orders and that you choose a solid fabric color for the seat portion.

Combination of Colors
Combination of different fabric colors available on quote request only.

Prices

Code	GRA	GR1	GR2	GR3	GR4	GR5	GR6	GR7	GR8	GR9	GR10	GR11	GR12	Cuir Leather
BC48	1341	1389	1455	1520	1603	1684	1766	1848	1929	2012	2093	2257	2421	2285

How to Order

Fabric
[See the Logiflex Graded-in List](#)

LL	-	IN	-	BC48	-			
		serie	code		supplier	pattern	color	

Example LL - IN - BC48 - ENNIS LOFT AQUA

Modular Seating

Infiniti - Rectangular Bench with Backrest

BCD48

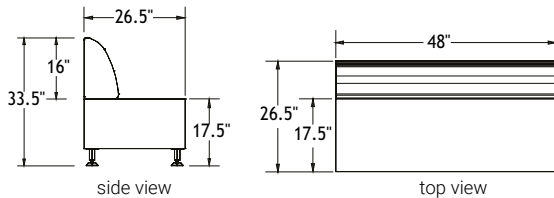
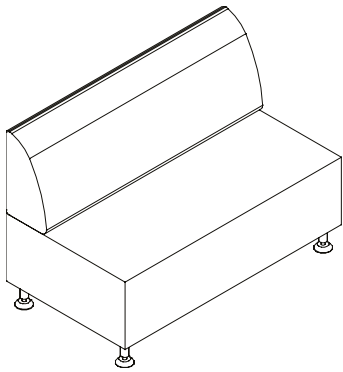

Combination of Colors

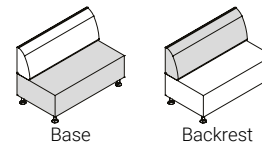

Manufacturing Standards

- 4 brushed chrome metal legs;
- Single top stitching;
- Elastic straps on seat and backrest;
- Firm density foam on seat and backrest;
- 1/2" thick polyester on the sides of the frame;
- Seat and backrest frames made out of recycled materials.

COM Fabrics: COM Fabrics are provided by the customer. For pricing please refer GR2 grade price.

Number of yards for COM fabric: [See Appendix B](#)

Code	Total	Base	Backrest
BCD48	4,75	3	1,75

Note: It is recommend that you include a layout with all orders and that you choose a solid fabric color for the seat portion.

Prices

Code	GRA	GR1	GR2	GR3	GR4	GR5	GR6	GR7	GR8	GR9	GR10	GR11	GR12	Cuir Leather
BCD48	2039	2120	2227	2334	2468	2602	2735	2870	3003	3137	3270	3539	3806	3583

How to Order

Fabric 1 (base)
[See the Logiflex Graded-in List](#)

Fabric 2 (backrest)
[See the Logiflex Graded-in List](#)

LL	-	IN	-	BCD48	-				-				
serie		code			supplier			pattern			color		

Example

LL	-	IN	-	BCD48	-	ENNIS	LOFT	AQUA	-	ENNIS	LOFT	AQUA
----	---	----	---	-------	---	-------	------	------	---	-------	------	------

Modular Seating

Infiniti - Rectangular Bench with 30" Backrest on Left

BCDC48L

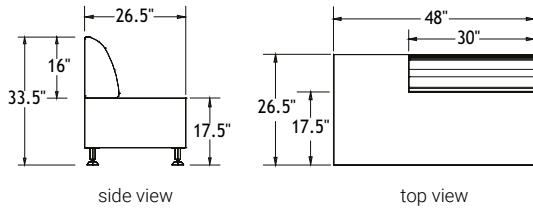
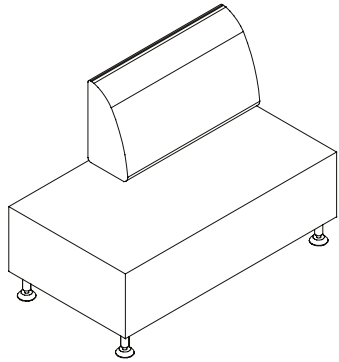

Manufacturing Standards

- 4 brushed chrome metal legs;
- Single top stitching;
- Elastic straps on seat and backrest;
- Firm density foam on seat and backrest;
- 1/2" thick polyester on the sides of the frame;
- Seat and backrest frames made out of recycled materials.

COM Fabrics: COM Fabrics are provided by the customer. For pricing please refer GR2 grade price.

Number of yards for COM fabric: [See Appendix B](#)

Code	Total	Base	Backrest
BCDC48L	4,5	3	1,5

Note: It is recommend that you include a layout with all orders and that you choose a solid fabric color for the seat portion.

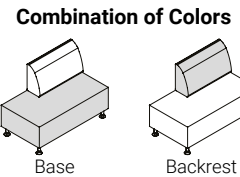

Prices

Code	GRA	GR1	GR2	GR3	GR4	GR5	GR6	GR7	GR8	GR9	GR10	GR11	GR12	Cuir Leather
BCDC48L	1990	2070	2177	2285	2418	2552	2685	2819	2954	3088	3221	3489	3756	3533

How to Order

Fabric 1 (base)
[See the Logiflex Graded-in List](#)

Fabric 2 (backrest)
[See the Logiflex Graded-in List](#)

LL	-	IN	-	BCDC48L	-				-			
serie		code			supplier	pattern	color	supplier	pattern	color		

Example LL - IN - BCDC48L - ENNIS LOFT AQUA - ENNIS LOFT AQUA

Modular Seating

Infiniti - Rectangular Bench with 30" Backrest on Right

BCDC48R

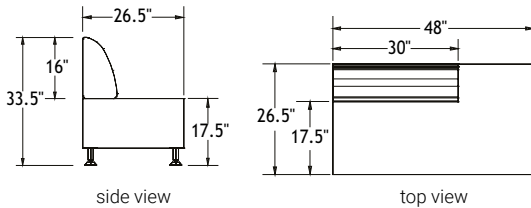
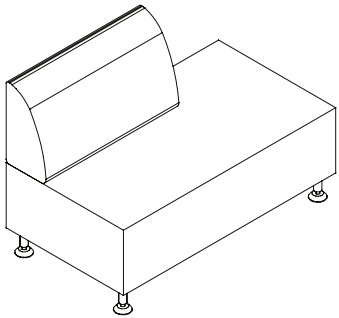

Combination of Colors

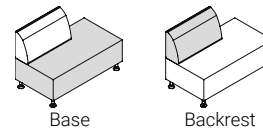

Manufacturing Standards

- 4 brushed chrome metal legs;
- Single top stitching;
- Elastic straps on seat and backrest;
- Firm density foam on seat and backrest;
- 1/2" thick polyester on the sides of the frame;
- Seat and backrest frames made out of recycled materials.

COM Fabrics: COM Fabrics are provided by the customer. For pricing please refer GR2 grade price.

Number of yards for COM fabric: [See Appendix B](#)

Code	Total	Base	Backrest
BCDC48R	4,5	3	1,5

Note: It is recommend that you include a layout with all orders and that you choose a solid fabric color for the seat portion.

Prices

Code	GRA	GR1	GR2	GR3	GR4	GR5	GR6	GR7	GR8	GR9	GR10	GR11	GR12	Cuir Leather
BCDC48R	1990	2070	2177	2285	2418	2552	2685	2819	2954	3088	3221	3489	3756	3533

How to Order

Fabric 1 (base)
[See the Logiflex Graded-in List](#)

Fabric 2 (backrest)
[See the Logiflex Graded-in List](#)

LL	-	IN	-	BCDC48R	-				-				
		serie			code	supplier	pattern	color			supplier	pattern	color

Example LL - IN - BCDC48R - ENNIS LOFT AQUA - ENNIS LOFT AQUA

Modular Seating



Clara - Circular Bench

CLA-O

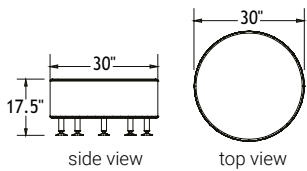
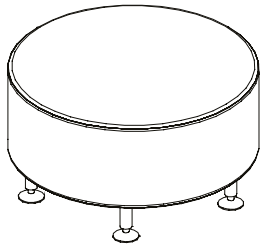

Manufacturing Standards

- 5 brushed chrome metal legs;
- Single top stitching;
- Firm density foam on seat;
- 1/2" thick polyester on the sides of the frame;
- Frame made out of recycled materials.

COM Fabrics: COM Fabrics are provided by the customer. For pricing please refer GR2 grade price.

Number of yards for COM fabric: [See Appendix B](#)

Code	Total
CLA	1,75

Note: It is recommend that you include a layout with all orders and that you choose a solid fabric color for the seat portion.

Combination of Colors
Combination of different fabric colors available on quote request only.

Prices														\$C\$uir
\$C\$ode	GRA	GR1	GR2	GR3	GR4	GR5	GR6	GR7	GR8	GR9	GR10	GR11	GR12	Leather
CLA-O	1420	1451	1494	1535	1586	1639	1690	1744	1795	1847	1899	2003	2106	2020

How to Order

Fabric
[See the Logiflex Graded-in List](#)

LL	-	CLA	-	O	-			
serie		code		supplier	pattern	color		

Example LL - CLA - O - ENNIS LOFT AQUA

Modular Seating



Clara - Circular Single Nestle Bench

CLA-S

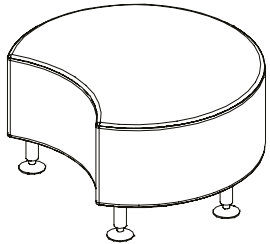

Manufacturing Standards

- 5 brushed chrome metal legs;
- Single top stitching;
- Firm density foam on seat;
- 1/2" thick polyester on the sides of the frame;
- Frame made out of recycled materials.

COM Fabrics: COM Fabrics are provided by the customer. For pricing please refer GR2 grade price.

Number of yards for COM fabric: [See Appendix B](#)

Code	Total
CLAS	1,75

Note: It is recommend that you include a layout with all orders and that you choose a solid fabric color for the seat portion.

Combination of Colors

Combination of different fabric colors available on quote request only.

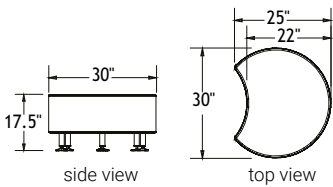

Prices

Code	GRA	GR1	GR2	GR3	GR4	GR5	GR6	GR7	GR8	GR9	GR10	GR11	GR12	Cuir Leather
CLA-S	1420	1451	1494	1535	1586	1639	1690	1744	1795	1847	1899	2003	2106	2020

How to Order

Fabric
See the Logiflex Graded-in List

LL	-	CLA	-	S	-			
serie		code		supplier	pattern	color		

Example LL - CLA - S - ENNIS LOFT AQUA

Modular Seating

Clara - Circular Double Nestle Bench

CLA-D

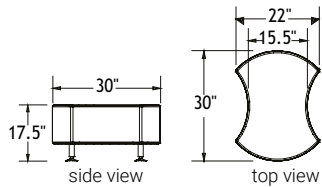
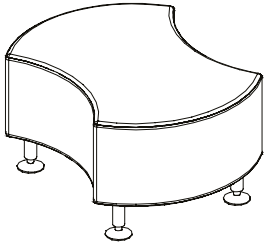

Manufacturing Standards

- 5 brushed chrome metal legs;
- Single top stitching;
- Firm density foam on seat;
- 1/2" thick polyester on the sides of the frame;
- Frame made out of recycled materials.

COM Fabrics: COM Fabrics are provided by the customer. For pricing please refer GR2 grade price.

Number of yards for COM fabric: [See Appendix B](#)

Code	Total
CLAD	1,75

Note: It is recommend that you include a layout with all orders and that you choose a solid fabric color for the seat portion.

Combination of Colors

Combination of different fabric colors available on quote request only.

Prices

Code	GRA	GR1	GR2	GR3	GR4	GR5	GR6	GR7	GR8	GR9	GR10	GR11	GR12	Cuir Leather
CLA-D	1420	1451	1494	1535	1586	1639	1690	1744	1795	1847	1899	2003	2106	2020

How to Order

Fabric

[See the Logiflex Graded-in List](#)

LL	-	CLA	-	D	-			
serie		code		supplier	pattern	color		

Example LL - CLA - D - ENNIS LOFT AQUA

Modular Seating

Clara - Circular Bench with Backrest

CLA-B

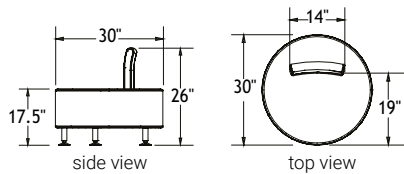
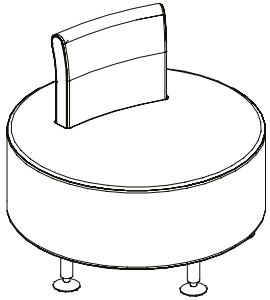

Manufacturing Standards

- 5 brushed chrome metal legs;
- Single top stitching;
- Elastic straps on backrest;
- Firm density foam on seat;
- 1/2" thick polyester on the sides of the frame;
- Frame made out of recycled materials.

COM Fabrics: COM Fabrics are provided by the customer. For pricing please refer GR2 grade price.

Number of yards for COM fabric: [See Appendix B](#)

Code	Total	Base	Backrest
CLAB	2,75	1,75	1

Note: It is recommend that you include a layout with all orders and that you choose a solid fabric color for the seat portion.

Combination of Colors

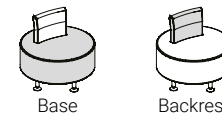

Prices

Code	GRA	GR1	GR2	GR3	GR4	GR5	GR6	GR7	GR8	GR9	GR10	GR11	GR12	Cuir Leather
CLA-B	2449	2485	2533	2580	2640	2700	2759	2818	2878	2938	2997	3116	3235	3135

How to Order

Fabric 1 (base)
[See the Logiflex Graded-in List](#)

Fabric 2 (backrest)
[See the Logiflex Graded-in List](#)

LL	-	CLA	-	B	-				-			
serie		code		supplier	pattern	color	supplier	pattern	color			

Example LL - CLA - B - ENNIS LOFT AQUA - ENNIS LOFT AQUA

Modular Seating

Leo - Circular Bench

PR16

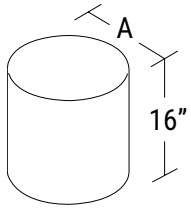

PR20

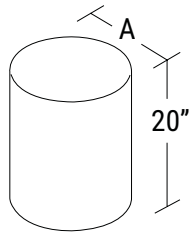

PR24

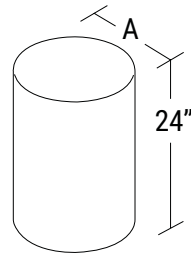

Combination of Colors
Request a quotation for the combination with 2 colors.

Manufacturing Standards

- Composed of a wood structure, covered in polyurethane foam;
- Layer of moisture-wicking material with a fabric cover;
- Available heights : 16", 20", and 24";
- Footing :
 - G : White nylon glides;
 - H : Casters for soft surface;
 - S : Casters for hard surface;
- Delivered assembled.

Casters : Available only on 18" and 24" in diameter and 16" and 20" high benches

COM Fabrics : COM Fabrics are provided by the customer. For pricing please refer GR2 grade price.

Number of yards for COM fabric: [See Appendix B](#)

Dimension	Total
18" L	1,6
24" L	2,5
36" L	3,5

Note: It is recommend that you include a layout with all orders.

Options

Footing

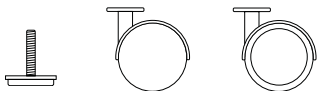

G
\$0

H
\$0

S
\$0

Prices

PR16	Dimensions													Cuir
	A	GRA	GR1	GR2	GR3	GR4	GR5	GR6	GR7	GR8	GR9	GR10	GR11	GR12
18	627	676	723	773	830	891	952	1010	1069	1129	1190	1308	1429	1226
24	1065	1138	1208	1282	1377	1468	1559	1650	1744	1834	1928	2110	2295	2103
36	1388	1492	1594	1696	1824	1950	2079	2207	2335	2462	2587	2844	3098	2761
PR20	Dimensions													Cuir
	A	GRA	GR1	GR2	GR3	GR4	GR5	GR6	GR7	GR8	GR9	GR10	GR11	GR12
18	646	694	743	787	850	907	969	1029	1087	1148	1206	1328	1448	1295
24	1099	1171	1245	1318	1411	1503	1594	1686	1778	1870	1959	2142	2326	2138
36	1451	1554	1655	1755	1882	2012	2138	2267	2395	2521	2650	2905	3159	2914
PR24	Dimensions													Cuir
	A	GRA	GR1	GR2	GR3	GR4	GR5	GR6	GR7	GR8	GR9	GR10	GR11	GR12
18	671	719	766	814	872	933	993	1053	1112	1171	1232	1350	1472	1378
24	1151	1225	1299	1371	1461	1555	1646	1739	1828	1920	2013	2196	2379	2190

How to Order

LL	-	LEO	-	PR24 PR20 PR16	A	G H S	-	-	-	-	-	-	-	-
serie		serie		code	dimension	footing		supplier	pattern	color				
Example	LL	LEO		PR24	18	G		ENNIS	LOFT	AQUA				

Modular Seating

Leo - Square Bench

PS16

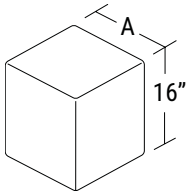

PS20

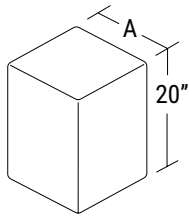

PS24

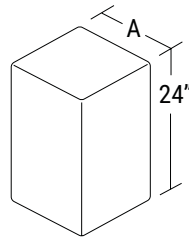

Combination of Colors
Request a quotation for the combination with 2 colors.

Manufacturing Standards

- Composed of a wood structure, covered in polyurethane foam;
- Layer of moisture-wicking material with a fabric cover;
- Available heights : 16", 20", and 24";
- Footing :
 - G : White nylon glides;
 - H : Casters for soft surface;
 - S : Casters for hard surface;
- Delivered assembled.

Casters : Available only on 18" and 24" in diameter and 16" and 20" high benches

COM Fabrics : COM Fabrics are provided by the customer. For pricing please refer GR2 grade price.

Number of yards for COM fabric: [See Appendix B](#)

Dimension	Total
18" L	1,8
24" L	2,7
36" L	3,7

Note: It is recommend that you include a layout with all orders.

Options

Footing

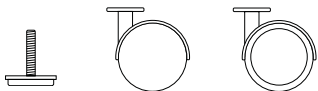

G \$0 **H** \$0 **S** \$0

Prices

PS16	Dimensions														Cuir
	A	GRA	GR1	GR2	GR3	GR4	GR5	GR6	GR7	GR8	GR9	GR10	GR11	GR12	Leather
18	685	739	791	844	907	974	1041	1104	1171	1238	1305	1434	1565	1355	
24	1128	1206	1286	1369	1467	1567	1667	1766	1864	1966	2065	2264	2464	2227	
36	1448	1556	1664	1772	1908	2041	2178	2315	2450	2585	2723	2991	3261	2948	

PS20	Dimensions														Cuir
	A	GRA	GR1	GR2	GR3	GR4	GR5	GR6	GR7	GR8	GR9	GR10	GR11	GR12	Leather
18	702	754	808	858	926	992	1057	1122	1188	1255	1318	1452	1582	1377	
24	1164	1242	1323	1402	1502	1602	1700	1800	1900	2000	2100	2299	2497	2264	
36	1506	1614	1723	1831	1967	2103	2237	2374	2510	2647	2781	3052	3325	3024	

PS24	Dimensions														Cuir
	A	GRA	GR1	GR2	GR3	GR4	GR5	GR6	GR7	GR8	GR9	GR10	GR11	GR12	Leather
18	728	781	832	886	952	1017	1084	1148	1212	1279	1346	1477	1610	1420	
24	1212	1295	1374	1453	1555	1651	1752	1853	1952	2052	2155	2351	2549	2298	

How to Order

LL	-	LEO	-	PS24 PS20 PS16	AA	G H S	-	-	-	-	-	-	-	-	-
serie		serie		code	dimension	footing		supplier	pattern	color					
Example	LL	LEO		PS24	1818	G		ENNIS	LOFT	AQUA					

Modular Seating

Leo - Rectangular Bench

PI16

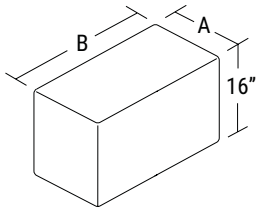

PI20

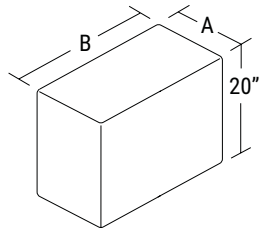

Manufacturing Standards

- Composed of a wood structure, covered in polyurethane foam;
- Layer of moisture-wicking material with a fabric cover;
- Available heights : 16" and 20";
- On White nylon glides;
- Delivered assembled.

COM Fabrics: COM Fabrics are provided by the customer. For pricing please refer GR2 grade price.

Number of yards for COM fabric: [See Appendix B](#)

Dimension	Total
24" L	2
30" L	2,4
36" L	2,5
48" L	3,2

Note: It is recommend that you include a layout with all orders.

Combination of Colors

Request a quotation for the combination with 2 colors.

Prices

PI16

Dimensions	GRA	GR1	GR2	GR3	GR4	GR5	GR6	GR7	GR8	GR9	GR10	GR11	GR12	Cuir Leather
A B														
1836	971	1044	1119	1193	1280	1374	1465	1557	1648	1741	1831	2015	2198	1936
1848	1305	1399	1495	1591	1712	1829	1949	2070	2189	2308	2428	2667	2907	2598

PI20

Dimensions	GRA	GR1	GR2	GR3	GR4	GR5	GR6	GR7	GR8	GR9	GR10	GR11	GR12	Cuir Leather
A B														
1424	679	737	795	852	925	995	1067	1138	1208	1280	1353	1500	1641	1397
1430	777	847	918	986	1074	1161	1248	1336	1424	1510	1602	1776	1950	1732
1836	1006	1077	1151	1225	1316	1409	1501	1591	1684	1776	1865	2051	2234	2017
1848	1353	1451	1545	1641	1760	1880	2001	2121	2239	2358	2478	2438	2957	2724

How to Order

LL	-	LEO	-	PI20	AB	-	G	-			
serie		serie		code	dimension		footing		supplier	pattern	color

Example LL - LEO - PI20 1836 - G - ENNIS LOFT AQUA

Modular Seating

Leo - Arched Bench

PC16

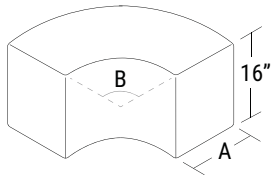

PC20

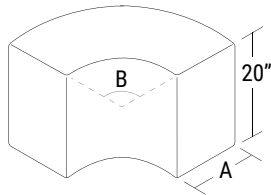

Manufacturing Standards

- Composed of a wood structure, covered in polyurethane foam;
- Layer of moisture-wicking material with a fabric cover;
- Available heights : 16" and 20";
- On White nylon glides;
- Delivered assembled.

COM Fabrics: COM Fabrics are provided by the customer. For pricing please refer GR2 grade price.

Number of yards for COM fabric: [See Appendix B](#)

Dimension	Total
16" L	2,8
20" L	2,8

Note: It is recommend that you include a layout with all orders.

Combination of Colors
Request a quotation for the combination with 2 colors.

Prices

PC16

Dimensions														Cuir	
A	B	GRA	GR1	GR2	GR3	GR4	GR5	GR6	GR7	GR8	GR9	GR10	GR11	GR12	Leather
1890		1194	1279	1365	1452	1559	1667	1776	1881	1989	2097	2206	2422	2635	2530

PC20

Dimensions														Cuir	
A	B	GRA	GR1	GR2	GR3	GR4	GR5	GR6	GR7	GR8	GR9	GR10	GR11	GR12	Leather
1890		1245	1332	1417	1504	1611	1720	1826	1934	2040	2151	2256	2472	2687	2654

How to Order

LL	-	LEO	-	PC20 PC16	-	AB	-	G	-						
serie		serie		code		dimension		footing		supplier		pattern		color	

Example LL - LEO - PC20 1890 - G - ENNIS LOFT AQUA

Modular Seating

Leo - Round Table

TMAR16

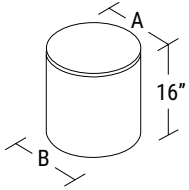

TMAR20

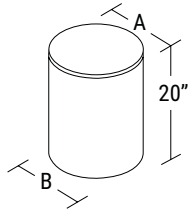

TMAR24

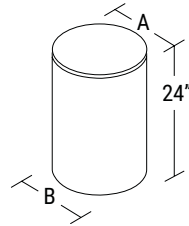

Combination of Colors
Request a quotation for the combination with 2 colors.

Manufacturing Standards

- Round table with 1" thick laminate or 1-1/16" thick marker board surface;
- Composed of a wood structure, covered in polyurethane foam;
- Layer of moisture-wicking material with a fabric cover;
- Available heights : 16", 20", and 24";
- On White nylon glides;
- Delivered assembled.

Marker board : Use the code W in the finishes column.

COM Fabrics: COM Fabrics are provided by the customer. For pricing please refer GR2 grade price.

Number of yards for COM fabric: [See Appendix B](#)

Dimension	Total
18" L	1,6
24" L	2,5
36" L	3,5

Note: It is recommend that you include a layout with all orders.

Prices

Laminat (L1)	Dimensions		GRA	GR1	GR2	GR3	GR4	GR5	GR6	GR7	GR8	GR9	GR10	GR11	GR12	Cuir Leather
	A	B														
TMAR16	1818		826	867	907	952	1003	1053	1104	1156	1207	1260	1312	1417	1521	1281
	2424		1306	1355	1406	1456	1523	1584	1649	1714	1777	1841	1906	2031	2160	2066
	3636		1878	1950	2023	2097	2189	2280	2373	2464	2554	2649	2738	2922	3105	2907
TMAR20	1818		844	883	926	966	1018	1069	1122	1173	1226	1277	1331	1431	1536	1452
	2424		1338	1388	1440	1492	1556	1619	1684	1749	1810	1875	1937	2066	2193	2084
	3636		1936	2012	2084	2158	2248	2341	2431	2525	2615	2708	2800	2983	3167	2975
TMAR24	1818		868	908	952	993	1044	1096	1148	1199	1252	1304	1355	1457	1563	1485
	2424		1392	1443	1494	1545	1609	1671	1735	1799	1863	1928	1989	2116	2245	2107
Marker board (MB)	Dimensions		GRA	GR1	GR2	GR3	GR4	GR5	GR6	GR7	GR8	GR9	GR10	GR11	GR12	Cuir Leather
	A	B														
TMAR16	1818		1094	1135	1175	1220	1271	1320	1372	1423	1475	1527	1580	1685	1789	1549
	2424		1574	1623	1674	1724	1791	1852	1917	1982	2045	2108	2173	2299	2428	2334
	3636		2145	2218	2291	2365	2457	2548	2641	2732	2822	2917	3006	3190	3373	3174
TMAR20	1818		1111	1151	1194	1234	1285	1337	1389	1441	1494	1545	1599	1698	1804	1720
	2424		1606	1656	1708	1760	1824	1887	1952	2017	2078	2142	2205	2334	2461	2351
	3636		2204	2279	2351	2426	2516	2609	2699	2792	2883	2976	3067	3251	3435	3242
TMAR24	1818		1136	1176	1220	1261	1312	1364	1416	1467	1520	1572	1623	1725	1830	1753
	2424		1659	1711	1761	1813	1877	1938	2002	2067	2131	2196	2257	2383	2513	2375

How to Order

LL	-	LEO	-	TMAR24 TMAR20 TMAR16	AB	-	L1 MB	-	Finishes See Appendix A	-	G	-	Fabric See the Logiflex Graded-in List	-		
serie		serie		code	dimension		surface		top		footing		supplier	pattern	color	
Example	LL	-	LEO	-	TMAR24	1818	-	L1	-	OHA	-	G	-	ENNIS	LOFT	AQUA

Modular Seating

Leo - Round Table (following)

TMAR20

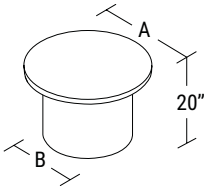

TMAR24

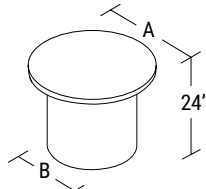

Manufacturing Standards

- Round table with 1" thick laminate or 1-1/16" thick marker board surface;
- Composed of a wood structure, covered in polyurethane foam;
- Layer of moisture-wicking material with a fabric cover;
- Available heights : 20", and 24";
- On White nylon glides;
- Delivered assembled.

Marker board : Use the code W in the finishes column.

COM Fabrics: COM Fabrics are provided by the customer. For pricing please refer GR2 grade price.

Number of yards for COM fabric: [See Appendix B](#)

Dimension	Total
203624	1,8
243624	1,8

Note: It is recommend that you include a layout with all orders.

Combination of Colors
Request a quotation for the combination with 2 colors.

Prices

Laminate (L1)	Dimensions		GRA	GR1	GR2	GR3	GR4	GR5	GR6	GR7	GR8	GR9	GR10	GR11	GR12	Cuir Leather
	A	B														
TMAR20	3624		1504	1556	1607	1658	1722	1786	1850	1912	1977	2040	2104	2233	2360	2184
TMAR24	3624		1556	1607	1658	1711	1772	1834	1900	1963	2027	2089	2156	2281	2410	2272
Marker board (MB)	Dimensions		GRA	GR1	GR2	GR3	GR4	GR5	GR6	GR7	GR8	GR9	GR10	GR11	GR12	Cuir Leather
	A	B														
TMAR20	3624		1772	1824	1875	1926	1990	2054	2118	2179	2244	2308	2372	2501	2628	2451
TMAR24	3624		1824	1875	1926	1979	2039	2102	2168	2231	2295	2357	2424	2549	2678	2540

How to Order

LL	-	LEO	-	TMAR24 TMAR20	AB	-	L1 MB	-	Finishes See Appendix A	-	G	-	Fabric See the Logiflex Graded-in List	-					
serie		serie		code	dimension		surface		top		footing		supplier	pattern	color				
Example		LL		LEO			TMAR24		3624		L1		OHA		G		ENNIS	LOFT	AQUA

Modular Seating

Leo - Square Table

TMAS16

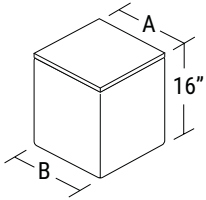

TMAS20

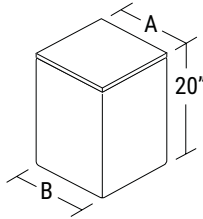

TMAS24

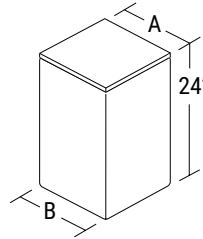

Combination of Colors
Request a quotation for the combination with 2 colors.

Manufacturing Standards

- Square table with 1" thick laminate or 1-1/16" thick marker board surface;
- Composed of a wood structure, covered in polyurethane foam;
- Layer of moisture-wicking material with a fabric cover;
- Available heights : 16", 20", and 24";
- On White nylon glides;
- Delivered assembled.

Marker board : Use the code W in the finishes column.

COM Fabrics: COM Fabrics are provided by the customer. For pricing please refer GR2 grade price.

Number of yards for COM fabric: [See Appendix B](#)

Dimension	Total
18" L	1,6
24" L	1,8
36" L	2,7

Note: It is recommend that you include a layout with all orders.

Prices

Laminat (L1)	Dimensions		GRA	GR1	GR2	GR3	GR4	GR5	GR6	GR7	GR8	GR9	GR10	GR11	GR12	Cuir Leather
	A	B														
TMAS16	1818	902	952	998	1045	1104	1167	1225	1282	1345	1405	1464	1583	1703	1565	
	2424	1345	1398	1451	1503	1569	1634	1700	1766	1831	1897	1963	2094	2227	2308	
	3636	1758	1838	1918	1999	2097	2197	2298	2397	2496	2598	2697	2892	3094	3098	
TMAS20	1818	921	967	1016	1063	1123	1182	1242	1304	1362	1421	1482	1604	1721	1581	
	2424	1379	1431	1484	1537	1604	1669	1733	1800	1864	1931	1999	2129	2262	2403	
	3636	1817	1897	1977	2056	2157	2254	2355	2456	2552	2653	2755	2953	3152	3167	
TMAS24	1818	945	993	1039	1087	1148	1206	1268	1328	1386	1448	1505	1628	1746	1607	
	2424	1430	1483	1536	1588	1655	1721	1786	1853	1918	1984	2050	2181	2313	2531	
	3636	1917	1970	2023	2076	2144	2212	2280	2348	2416	2484	2552	2721	2890	3159	
Marker board (MB)	Dimensions		GRA	GR1	GR2	GR3	GR4	GR5	GR6	GR7	GR8	GR9	GR10	GR11	GR12	Cuir Leather
	A	B														
TMAS16	1818	1170	1220	1266	1313	1372	1435	1492	1550	1613	1673	1731	1851	1970	1832	
	2424	1613	1666	1719	1771	1836	1901	1967	2034	2099	2165	2231	2362	2495	2576	
	3636	2026	2105	2186	2267	2365	2465	2566	2665	2763	2865	2964	3160	3362	3366	
TMAS20	1818	1189	1235	1283	1331	1391	1450	1510	1570	1629	1689	1731	1872	1989	1849	
	2424	1647	1698	1752	1805	1872	1936	2001	2034	2132	2199	2231	2397	2530	2671	
	3636	2085	2165	2244	2324	2425	2521	2622	2665	2820	2921	2964	3221	3420	3435	
TMAS24	1818	1212	1261	1307	1354	1416	1474	1536	1572	1654	1716	1750	1896	2014	1875	
	2424	1697	1751	1804	1856	1923	1989	2054	2068	2186	2252	2267	2448	2581	2799	
	3636	2181	2244	2307	2369	2444	2521	2600	2665	2820	2921	2964	3221	3420	3435	

How to Order

LL	-	LEO	-	TMAS24 TMAS20 TMAS16	AB	-	L1 MB	-	Finishes See Appendix A	-	G	-	Fabric See the Logiflex Graded-in List	-		
serie		serie		code	dimension		surface		top		footing		supplier	pattern	color	
Example	LL	-	LEO	-	TMAS24	1818	-	L1	-	OHA	-	G	-	ENNIS	LOFT	AQUA

Modular Seating

Leo - Square Table (following)

TMAS20

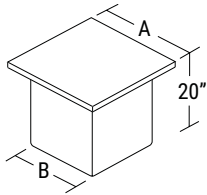

TMAS24

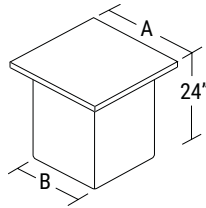

Manufacturing Standards

- Square table with 1" thick laminate or 1-1/16" thick marker board surface;
- Composed of a wood structure, covered in polyurethane foam;
- Layer of moisture-wicking material with a fabric cover;
- Available heights : 20", and 24";
- On White nylon glides;
- Delivered assembled.

Marker board : Use the code W in the finishes column.

COM Fabrics: COM Fabrics are provided by the customer. For pricing please refer GR2 grade price.

Number of yards for COM fabric: [See Appendix B](#)

Dimension	Total
203624	1,8
243624	1,8

Note: It is recommend that you include a layout with all orders.

Combination of Colors
Request a quotation for the combination with 2 colors.

Prices

Laminate (L1)	Dimensions		GRA	GR1	GR2	GR3	GR4	GR5	GR6	GR7	GR8	GR9	GR10	GR11	GR12	Cuir Leather
	A	B														
TMAS20	3624		1672	1723	1774	1825	1890	1952	2017	2080	2142	2208	2271	2399	2528	2675
TMAS24	3624		1722	1774	1825	1876	1937	2003	2066	2130	2195	2258	2323	2449	2576	2800
Marker board (MB)	Dimensions		GRA	GR1	GR2	GR3	GR4	GR5	GR6	GR7	GR8	GR9	GR10	GR11	GR12	Cuir Leather
	A	B														
TMAS20	3624		1939	1991	2041	2093	2158	2220	2285	2347	2410	2476	2539	2667	2795	2943
TMAS24	3624		1990	2041	2093	2143	2205	2271	2334	2398	2463	2526	2590	2717	2844	3067

How to Order

LL	-	LEO	-	TMAS24 TMAS20	AB	-	L1 MB	-	Finishes See Appendix A	-	G	-	Fabric See the Logiflex Graded-in List						
serie		serie		code	dimension		surface		top		footing		supplier	pattern	color				
Example		LL		LEO			TMAS24		3624		L1		OHA		G		ENNIS	LOFT	AQUA

Modular Seating

Leo Flow - Interactive Seating

PR16

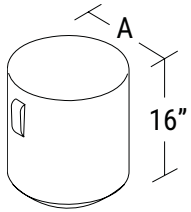

PR20

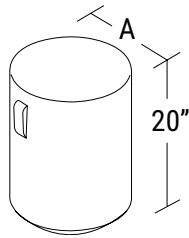

PR24

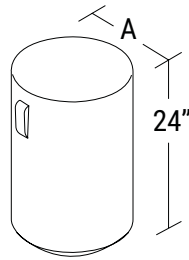

PR26

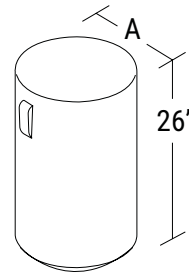

Combination of Colors
Request a quotation for the combination with 2 colors.

Manufacturing Standards

- The seat is composed of a wood structure, covered in polyurethane foam;
- Layer of moisture-wicking fiber, with a fabric cover;
- The 12" diameter base is made of rounded charcoal-colored molded plastic;
- Available heights of 16', 20', 24' and 26';
- A colored strap on the side, helps with moving the module;
- Delivered assembled.

Strap Colors : Black (H01)(std), Charcoal (H02), Grey (H03), Red (H04), Orange (H05), Yellow (H06), Blue (H07), Navy (H08), Green (H09), Olive (H10), Bordeaux (H11), Tan (H12).

COM Fabrics: COM Fabrics are provided by the customer. For pricing please refer GR2 grade price.

Number of yards for COM fabric: [See Appendix B](#)

Dimension	Total	Dimension	Total
1612	1	2018	1,6
1614	1,2	2414	1,4
2014	1,3	2614	1,5

Note: It is recommend that you include a layout with all orders.

Options

Strap Colors

See [Appendix A](#) for how to specify upholstery



Prices

PR16	Dimensions														Cuir
	A	GRA	GR1	GR2	GR3	GR4	GR5	GR6	GR7	GR8	GR9	GR10	GR11	GR12	Leather
	12	606	636	666	694	730	766	800	836	873	907	945	1017	1088	999
	14	657	693	726	761	808	851	893	936	981	1023	1069	1156	1244	1124
PR20	Dimensions														Cuir
	A	GRA	GR1	GR2	GR3	GR4	GR5	GR6	GR7	GR8	GR9	GR10	GR11	GR12	Leather
	14	673	710	748	786	832	882	930	979	1026	1073	1121	1220	1310	1174
	18	803	852	899	946	1007	1067	1124	1186	1245	1306	1364	1484	1605	1461
PR24	Dimensions														Cuir
	A	GRA	GR1	GR2	GR3	GR4	GR5	GR6	GR7	GR8	GR9	GR10	GR11	GR12	Leather
	14	697	737	780	821	872	925	976	1029	1077	1130	1182	1285	1388	1222
PR26	Dimensions														Cuir
	A	GRA	GR1	GR2	GR3	GR4	GR5	GR6	GR7	GR8	GR9	GR10	GR11	GR12	Leather
	14	711	757	800	847	901	958	1012	1069	1124	1180	1235	1347	1457	1273

How to Order

LL	-	LEOF	-		A	-	F	-				-	
serie		serie		code	dimension		footing		supplier	pattern	color		color
PR26 PR24 PR20 PR16													
Example				PR24	18		F		ENNIS	LOFT	AQUA		H01

Soft Seating

Bulexi - Armchair

BUL1

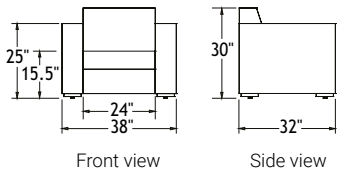
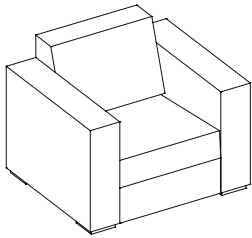

Manufacturing Standards

- Set of 4 wood legs BWL or 4 metal legs with Chrome finish (CHR);
- Double top stitching;
- Elastic straps on backrest;
- 9 GA springs within the seat;
- Medium-density foam on the seat;
- Medium-density foam with 1" of memory foam for the backrest;
- All cushions are covered with stitched Dacron;
- Backrest cushions are fixed to the structure by a zipper;
- Made out of recycled materials, seating and backrest structure made of hardwood and plywood.

Wood finishes: Available colors: White Wash WW, Golden Wheat GW, Sand SD, Apricot AT, Pecan PN, Brandy BR, Chestnut CT, Coffee CF, Espresso ES, Bordeaux BO, Black Wash BW and Bark BK.

COM Fabrics: COM Fabrics are provided by the customer. For pricing please refer GR2 grade price.

Number of yards for COM fabric: [See Appendix B](#)

Code	Total (1 fabric)	Frame	Seat and backrest
BUL1	5,2	3,8	2,2

Combination of Colors

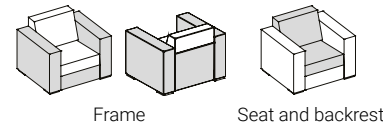

Prices

Code	GRA	GR1	GR2	GR3	GR4	GR5	GR6	GR7	GR8	GR9	GR10	GR11	GR12	Cuir Leather
BUL1 BWL	2526	2623	2754	2885	3049	3214	3376	3540	3703	3868	4030	4357	4685	4413
BUL1 BML CHR	3157	3256	3387	3517	3680	3845	4008	4172	4334	4499	4663	4989	5317	5044

How to Order

Finishes
[See the Logiflex Color Guide](#)

Fabric 1 (frame)
[See the Logiflex Graded-in List](#)

Fabric 2 (seat and backrest)
[See the Logiflex Graded-in List](#)

LL	-	BUL1	-	BWL	-	-	-	-	-	-	-	-	-	-
----	---	------	---	-----	---	---	---	---	---	---	---	---	---	---

serie code legs legs color supplier pattern color supplier pattern color

Example

LL	-	BUL1	-	BWL	-	BK	-	ENNIS	LOFT	AQUA	-	ENNIS	LOFT	AQUA
----	---	------	---	-----	---	----	---	-------	------	------	---	-------	------	------

Fabric 1 (frame)
[See the Logiflex Graded-in List](#)

Fabric 2 (seat and backrest)
[See the Logiflex Graded-in List](#)

LL	-	BUL1	-	BML	-	CHR	-	-	-	-	-	-	-	-
----	---	------	---	-----	---	-----	---	---	---	---	---	---	---	---

serie code legs metal finish supplier pattern color supplier pattern color

Example

LL	-	BUL1	-	BML	-	CHR	-	ENNIS	LOFT	AQUA	-	ENNIS	LOFT	AQUA
----	---	------	---	-----	---	-----	---	-------	------	------	---	-------	------	------

Soft Seating

Bulexi - Loveseat

BUL2

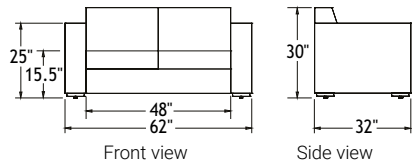
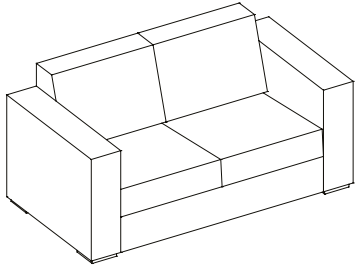

Combination of Colors

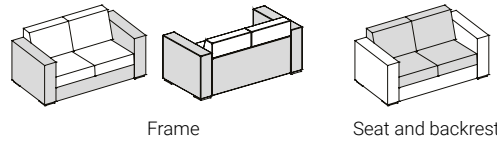

Manufacturing Standards

- Set of 4 wood legs BWL or 4 metal legs with Chrome finish (CHR);
- Double top stitching;
- Elastic straps on backrest;
- 9 GA springs within the seat;
- Medium-density foam on the seat;
- Medium-density foam with 1" of memory foam for the backrest;
- All cushions are covered with stitched Dacron;
- Backrest cushions are fixed to the structure by a zipper;
- Made out of recycled materials, seating and backrest structure made of hardwood and plywood.

Wood finishes: Available colors: White Wash WW, Golden Wheat GW, Sand SD, Apricot AT, Pecan PN, Brandy BR, Chestnut CT, Coffee CF, Espresso ES, Bordeaux BO, Black Wash BW and Bark BK.

COM Fabrics: COM Fabrics are provided by the customer. For pricing please refer GR2 grade price.

Number of yards for COM fabric: [See Appendix B](#)

Code	Total (1 fabric)	Frame	Seat and backrest
BUL2	8,5	4,7	4

Prices

Code	GRA	GR1	GR2	GR3	GR4	GR5	GR6	GR7	GR8	GR9	GR10	GR11	GR12	Cuir Leather
BUL2 BWL	3911	4053	4244	4434	4672	4910	5148	5386	5624	5862	6100	6576	7051	6655
BUL2 BML CHR	4527	4670	4861	5051	5289	5527	5765	6003	6241	6479	6717	7192	7668	7271

How to Order

Finishes
See the Logiflex Color Guide

Fabric 1 (frame)
See the Logiflex Graded-in List

Fabric 2 (seat and backrest)
See the Logiflex Graded-in List

LL	-	BUL2	-	BWL	-	-	-	-	-	-	-	-	-	-
----	---	------	---	-----	---	---	---	---	---	---	---	---	---	---

serie code legs legs color supplier pattern color supplier pattern color

Example

LL	-	BUL2	-	BWL	-	BK	-	ENNIS	LOFT	AQUA	-	ENNIS	LOFT	AQUA
----	---	------	---	-----	---	----	---	-------	------	------	---	-------	------	------

Fabric 1 (frame)
See the Logiflex Graded-in List

Fabric 2 (seat and backrest)
See the Logiflex Graded-in List

LL	-	BUL2	-	BML	-	CHR	-	-	-	-	-	-	-	-
----	---	------	---	-----	---	-----	---	---	---	---	---	---	---	---

serie code legs metal finish supplier pattern color supplier pattern color

Example

LL	-	BUL2	-	BML	-	CHR	-	ENNIS	LOFT	AQUA	-	ENNIS	LOFT	AQUA
----	---	------	---	-----	---	-----	---	-------	------	------	---	-------	------	------

Soft Seating

Bulexi - Sofa

BUL3

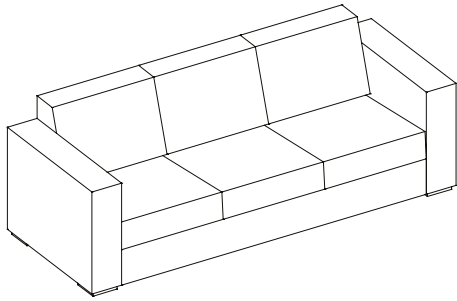

Combination of Colors

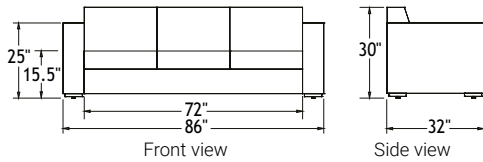
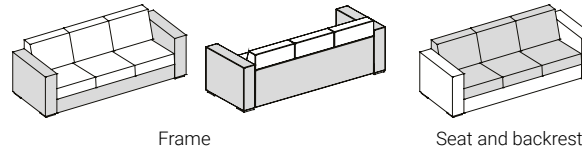

Manufacturing Standards

- Set of 4 wood legs BWL or 4 metal legs with Chrome finish (CHR);
- Double top stitching;
- Elastic straps on backrest;
- 9 GA springs within the seat;
- Medium-density foam on the seat;
- Medium-density foam with 1" of memory foam for the backrest;
- All cushions are covered with stitched Dacron;
- Backrest cushions are fixed to the structure by a zipper;
- Made out of recycled materials, seating and backrest structure made of hardwood and plywood.

Wood finishes: Available colors: White Wash WW, Golden Wheat GW, Sand SD, Apricot AT, Pecan PN, Brandy BR, Chestnut CT, Coffee CF, Espresso ES, Bordeaux BO, Black Wash BW and Bark BK.

COM Fabrics: COM Fabrics are provided by the customer. For pricing please refer GR2 grade price.

Number of yards for COM fabric: [See Appendix B](#)

Code	Total (1 fabric)	Frame	Seat and backrest
BUL3	11,6	5,6	6

Prices

Code	GRA	GR1	GR2	GR3	GR4	GR5	GR6	GR7	GR8	GR9	GR10	GR11	GR12	Cuir Leather
BUL3 BWL	4973	5160	5410	5660	5972	6285	6596	6908	7221	7533	7846	8471	9094	8574
BUL3 BML CHR	5607	5795	6044	6294	6606	6920	7231	7544	7856	8169	8480	9105	9729	9209

How to Order

Finishes
See the Logiflex Color Guide

Fabric 1 (frame)
See the Logiflex Graded-in List

Fabric 2 (seat and backrest)
See the Logiflex Graded-in List

LL	-	BUL3	-	BWL	-	-	-	-	-	-	-	-	-	-
----	---	------	---	-----	---	---	---	---	---	---	---	---	---	---

serie code legs legs color supplier pattern color supplier pattern color

Example

LL	-	BUL3	-	BWL	-	BK	-	ENNIS	LOFT	AQUA	-	ENNIS	LOFT	AQUA
----	---	------	---	-----	---	----	---	-------	------	------	---	-------	------	------

Fabric 1 (frame)
See the Logiflex Graded-in List

Fabric 2 (seat and backrest)
See the Logiflex Graded-in List

LL	-	BUL3	-	BML	-	CHR	-	-	-	-	-	-	-	-
----	---	------	---	-----	---	-----	---	---	---	---	---	---	---	---

serie code legs metal finish supplier pattern color supplier pattern color

Example

LL	-	BUL3	-	BML	-	CHR	-	ENNIS	LOFT	AQUA	-	ENNIS	LOFT	AQUA
----	---	------	---	-----	---	-----	---	-------	------	------	---	-------	------	------

Soft Seating

Flint - Armchair

FB1G

On levelers

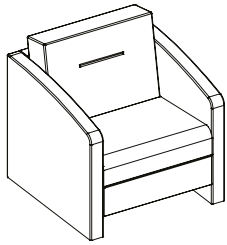

Combination of Colors

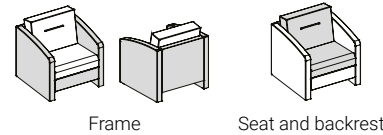

Manufacturing Standards

- Single top stitching;
- 9 GA springs for the seat and 11 GA for the backrest;
- Medium-density foam on seat and backrest;
- Firm density foam on the top of the armrests;
- Hardwood plywood structure.

COM Fabrics: COM Fabrics are provided by the customer. For pricing please refer GR2 grade price.

Number of yards for COM fabric: [See Appendix B](#)

Code	Total (1 fabric)	Frame	Seat and backrest
FB1G	5,25	4,1	2

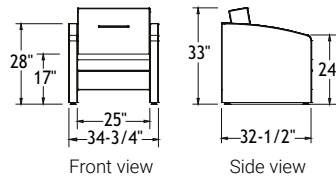

Prices

Code	GRA	GR1	GR2	GR3	GR4	GR5	GR6	GR7	GR8	GR9	GR10	GR11	GR12	Cuir Leather
FB1 G	1896	1998	2136	2272	2443	2614	2785	2957	3128	3299	3469	3811	4153	3869

How to Order

Fabric 1 (frame)
See the Logiflex Graded-in List

Fabric 2 (seat and backrest)
See the Logiflex Graded-in List

LL	-	FB1	-	G	-				-			
serie		code		legs		supplier	pattern	color		supplier	pattern	color

Example LL - FB1 - G - ENNIS LOFT AQUA - ENNIS LOFT AQUA

Soft Seating

Flint - Loveseat

FB2G

On levelers

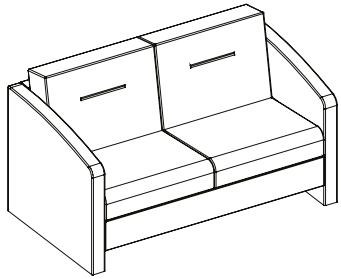

Combination of Colors

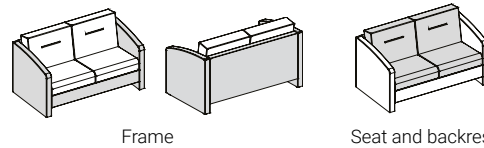

Manufacturing Standards

- Single top stitching;
- 9 GA springs for the seat and 11 GA for the backrest;
- Medium-density foam on seat and backrest;
- Firm density foam on the top of the armrests;
- Hardwood plywood structure.

COM Fabrics: COM Fabrics are provided by the customer. For pricing please refer GR2 grade price.

Number of yards for COM fabric: [See Appendix B](#)

Code	Total (1 fabric)	Frame	Seat and backrest
FB2G	7,4	4,3	3,6

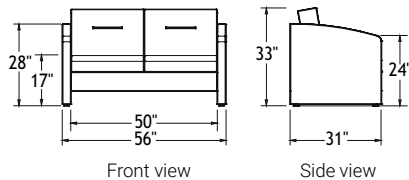

Prices

Code	GRA	GR1	GR2	GR3	GR4	GR5	GR6	GR7	GR8	GR9	GR10	GR11	GR12	Cuir Leather
FB2 G	2712	2851	3035	3220	3451	3680	3911	4143	4372	4603	4833	5294	5755	5370

How to Order

Fabric 1 (frame)
[See the Logiflex Graded-in List](#)

Fabric 2 (seat and backrest)
[See the Logiflex Graded-in List](#)

LL	-	FB2	-	G	-				-				
serie		code		legs		supplier	pattern	color		supplier	pattern	color	

Example LL - FB2 - G - ENNIS LOFT AQUA - ENNIS LOFT AQUA

Soft Seating

Flint - Sofa

FB3G

On levelers

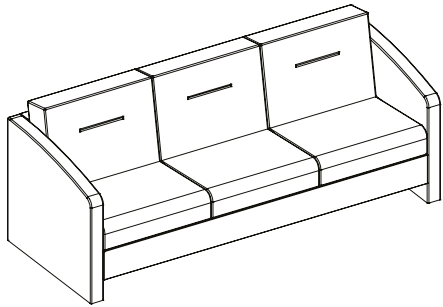

Combination of Colors

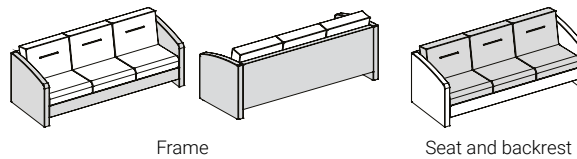

Frame

Seat and backrest

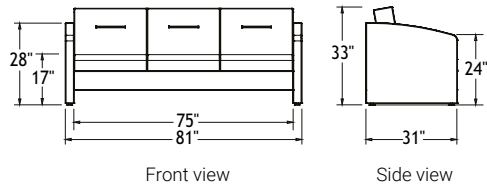

Front view

Side view

Manufacturing Standards

- Single top stitching;
- 9 GA springs for the seat and 11 GA for the backrest;
- Medium-density foam on seat and backrest;
- Firm density foam on the top of the armrests;
- Hardwood plywood structure.

COM Fabrics: COM Fabrics are provided by the customer. For pricing please refer GR2 grade price.

Number of yards for COM fabric: [See Appendix B](#)

Code	Total (1 fabric)	Frame	Seat and backrest
FB3G	9,8	5,2	5,7

Prices

Code	GRA	GR1	GR2	GR3	GR4	GR5	GR6	GR7	GR8	GR9	GR10	GR11	GR12	Cuir Leather
FB3 G	3672	3858	4109	4359	4671	4983	5295	5607	5920	6233	6545	7169	7793	7273

How to Order

Fabric 1 (frame)
See the Logiflex Graded-in List

Fabric 2 (seat and backrest)
See the Logiflex Graded-in List

LL	-	FB3	-	G	-									
serie		code		legs		supplier	pattern	color		supplier	pattern	color		

Example	LL	-	FB3	-	G	-	ENNIS	LOFT	AQUA	-	ENNIS	LOFT	AQUA	
----------------	----	---	-----	---	---	---	-------	------	------	---	-------	------	------	--

Soft Seating

Flint - Armchair

FB1OVAM

4 oval metal corner legs on levelers

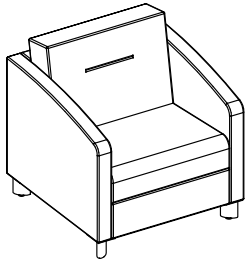

Manufacturing Standards

- Single top stitching;
- 9 GA springs for the seat and 11 GA for the backrest;
- Medium-density foam on seat and backrest;
- Firm density foam on the top of the armrests;
- Hardwood plywood structure.

COM Fabrics: COM Fabrics are provided by the customer. For pricing please refer GR2 grade price.

Number of yards for COM fabric: [See Appendix B](#)

Code	Total (1 fabric)	Frame	Seat and backrest
FB1OVAM	5,25	4,1	2

Combination of Colors

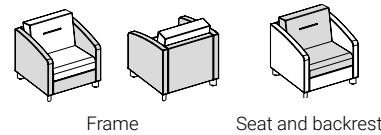

Frame

Seat and backrest

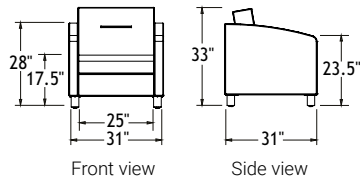

Prices

Code	GRA	GR1	GR2	GR3	GR4	GR5	GR6	GR7	GR8	GR9	GR10	GR11	GR12	Cuir Leather
FB1 OVAM	1896	1998	2136	2272	2443	2614	2785	2957	3128	3299	3469	3811	4153	3869

How to Order

Fabric 1 (frame)
[See the Logiflex Graded-in List](#)

Fabric 2 (seat and backrest)
[See the Logiflex Graded-in List](#)

LL	-	FB1	-	OVAM	-	SN	-				-			
serie		code		legs		metal finish		supplier	pattern	color		supplier	pattern	color

Example LL - FB1 - OVAM - SN - ENNIS - LOFT - AQUA - ENNIS - LOFT - AQUA

Soft Seating

Flint - Loveseat

FB2OVAM

4 oval metal corner legs on levelers

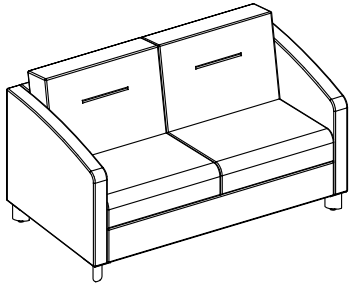

Combination of Colors

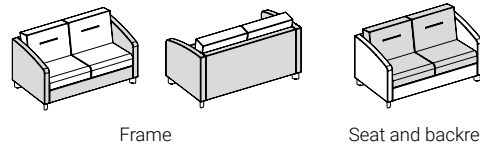

Manufacturing Standards

- Single top stitching;
- 9 GA springs for the seat and 11 GA for the backrest;
- Medium-density foam on seat and backrest;
- Firm density foam on the top of the armrests;
- Hardwood plywood structure.

COM Fabrics: COM Fabrics are provided by the customer. For pricing please refer GR2 grade price.

Number of yards for COM fabric: [See Appendix B](#)

Code	Total (1 fabric)	Frame	Seat and backrest
FB2OVAM	7,4	4,3	3,6

Prices

Code	GRA	GR1	GR2	GR3	GR4	GR5	GR6	GR7	GR8	GR9	GR10	GR11	GR12	Cuir Leather
FB2OVAM	2712	2851	3035	3220	3451	3680	3911	4143	4372	4603	4833	5294	5755	5370

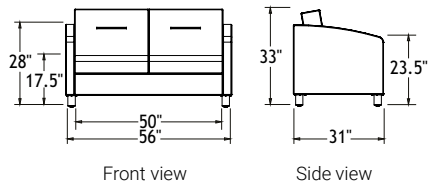

How to Order

Fabric 1 (frame)

[See the Logiflex Graded-in List](#)

Fabric 2 (seat and backrest)

[See the Logiflex Graded-in List](#)

LL	-	FB2	-	OVAM	-	SN	-				-			
serie		code		legs		metal finish		supplier	pattern	color		supplier	pattern	color

Example

LL	-	FB2	-	OVAM	-	SN	-	ENNIS	LOFT	AQUA	-	ENNIS	LOFT	AQUA
----	---	-----	---	------	---	----	---	-------	------	------	---	-------	------	------

Soft Seating

Flint - Sofa

FB3OVAM

4 oval metal corner legs on levelers

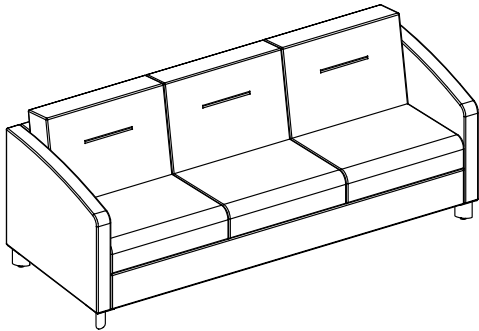

Combination of Colors

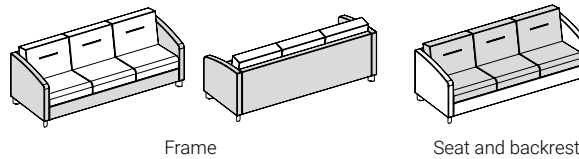

Manufacturing Standards

- Single top stitching;
- 9 GA springs for the seat and 11 GA for the backrest;
- Medium-density foam on seat and backrest;
- Firm density foam on the top of the armrests;
- Hardwood plywood structure.

COM Fabrics: COM Fabrics are provided by the customer. For pricing please refer GR2 grade price.

Number of yards for COM fabric: [See Appendix B](#)

Code	Total (1 fabric)	Frame	Seat and backrest
FB3OVAM	9,8	5,2	5,7

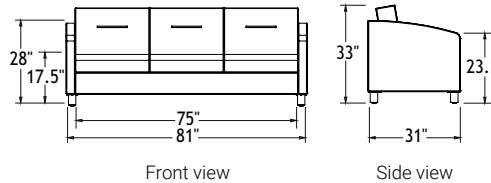

Prices

Code	GRA	GR1	GR2	GR3	GR4	GR5	GR6	GR7	GR8	GR9	GR10	GR11	GR12	Cuir Leather
FB3 OVAM	3672	3858	4109	4359	4671	4983	5295	5607	5920	6233	6545	7169	7793	7273

How to Order

Fabric 1 (frame)
[See the Logiflex Graded-in List](#)

Fabric 2 (seat and backrest)
[See the Logiflex Graded-in List](#)

LL	-	FB3	-	OVAM	-	SN	-				-			
serie		code		legs		metal finish		supplier	pattern	color		supplier	pattern	color

Example

LL	-	FB3	-	OVAM	-	SN	-	ENNIS	LOFT	AQUA	-	ENNIS	LOFT	AQUA
----	---	-----	---	------	---	----	---	-------	------	------	---	-------	------	------

Soft Seating

Flint - Armchair

FB1W

Wooden base with 4 FBW legs

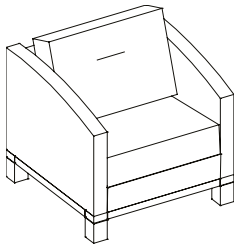

Manufacturing Standards

- Single top stitching;
- 9 GA springs for the seat and 11 GA for the backrest;
- Medium-density foam on seat and backrest;
- Firm density foam on the top of the armrests;
- Hardwood plywood structure.

Wood finishes: Available colors: White Wash WW, Golden Wheat GW, Sand SD, Apricot AT, Pecan PN, Brandy BR, Chestnut CT, Coffee CF, Espresso ES, Bordeaux BO, Black Wash BW and Bark BK.

COM Fabrics: COM Fabrics are provided by the customer. For pricing please refer GR2 grade price.

Number of yards for COM fabric: [See Appendix B](#)

Code	Total (1 fabric)	Frame	Seat and backrest
FB1W	5,25	4,1	2

Combination of Colors

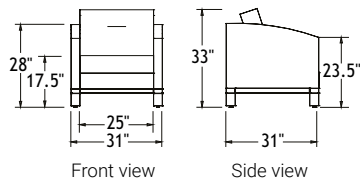
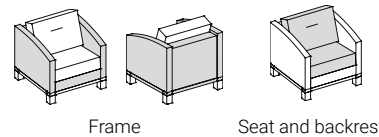

Prices

Code	GRA	GR1	GR2	GR3	GR4	GR5	GR6	GR7	GR8	GR9	GR10	GR11	GR12	Cuir Leather
FB1 W	1999	2071	2166	2262	2380	2500	2618	2738	2856	2976	3094	3332	3570	3372

How to Order

Finishes
See the Logiflex Color Guide

Fabric 1 (frame)
See the Logiflex Graded-in List

Fabric 2 (seat and backrest)
See the Logiflex Graded-in List

LL	-	FB1	-	W	-		-				-			
serie		code		legs		legs color		supplier	pattern	color		supplier	pattern	color

Example LL - FB1 - W - SN - ENNIS - LOFT - AQUA - ENNIS - LOFT - AQUA

Soft Seating

Flint - Loveseat

FB2W

Wooden base with 4 FBW legs

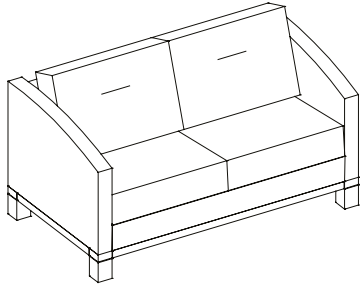

Combination of Colors

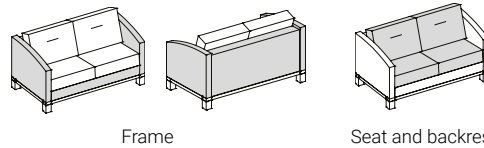

Frame

Seat and backrest

Manufacturing Standards

- Single top stitching;
- 9 GA springs for the seat and 11 GA for the backrest;
- Medium-density foam on seat and backrest;
- Firm density foam on the top of the armrests;
- Hardwood plywood structure.

Wood finishes: Available colors: White Wash WW, Golden Wheat GW, Sand SD, Apricot AT, Pecan PN, Brandy BR, Chestnut CT, Coffee CF, Espresso ES, Bordeaux BO, Black Wash BW and Bark BK.

COM Fabrics: COM Fabrics are provided by the customer. For pricing please refer GR2 grade price.

Number of yards for COM fabric: [See Appendix B](#)

Code	Total (1 fabric)	Frame	Seat and backrest
FB2W	7,4	4,3	3,6

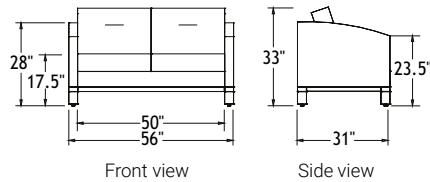

Front view

Side view

Prices

Code	GRA	GR1	GR2	GR3	GR4	GR5	GR6	GR7	GR8	GR9	GR10	GR11	GR12	Cuir Leather
FB2 W	3090	3224	3402	3581	3804	4027	4251	4473	4696	4919	5143	5588	6035	5663

How to Order

Finishes
See the Logiflex Color Guide

Fabric 1 (frame)
See the Logiflex Graded-in List

Fabric 2 (seat and backrest)
See the Logiflex Graded-in List

LL	-	FB2	-	W	-	-	-	-	-	-	-	-	-	-
serie		code		legs		legs color	supplier	pattern	color	supplier	pattern	color		

Example	LL	-	FB2	-	W	-	SN	-	ENNIS	LOFT	AQUA	-	ENNIS	LOFT	AQUA
----------------	----	---	-----	---	---	---	----	---	-------	------	------	---	-------	------	------

Soft Seating

Flint - Sofa

FB3W

Wooden base with 4 FBW legs

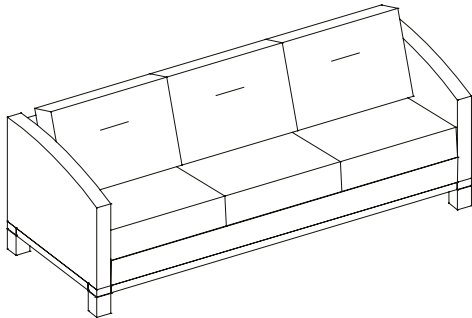

Combination of Colors

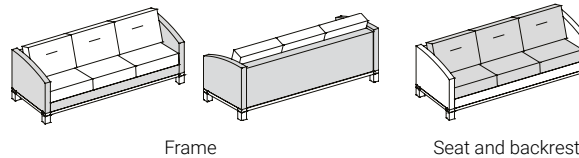

Manufacturing Standards

- Single top stitching;
- 9 GA springs for the seat and 11 GA for the backrest;
- Medium-density foam on seat and backrest;
- Firm density foam on the top of the armrests;
- Hardwood plywood structure.

Wood finishes: Available colors: White Wash WW, Golden Wheat GW, Sand SD, Apricot AT, Pecan PN, Brandy BR, Chestnut CT, Coffee CF, Espresso ES, Bordeaux BO, Black Wash BW and Bark BK.

COM Fabrics: COM Fabrics are provided by the customer. For pricing please refer GR2 grade price.

Number of yards for COM fabric: [See Appendix B](#)

Code	Total (1 fabric)	Frame	Seat and backrest
FB3W	9,8	5,2	5,7

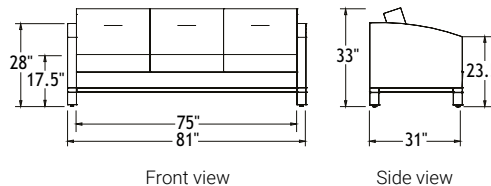

Prices

Code	GRA	GR1	GR2	GR3	GR4	GR5	GR6	GR7	GR8	GR9	GR10	GR11	GR12	Cuir Leather
FB3 W	3936	4118	4363	4606	4911	5216	5521	5826	6130	6435	6740	7350	7960	7452

How to Order

Finishes
See the Logiflex Color Guide

Fabric 1 (frame)
See the Logiflex Graded-in List

Fabric 2 (seat and backrest)
See the Logiflex Graded-in List

LL	-	FB3	-	W	-	-	-	-	-	-	-	-	-	-	-
serie		code		legs		legs color	supplier	pattern	color	supplier	pattern	color			
Example	LL	-	FB3	-	W	-	SN	-	ENNIS	LOFT	AQUA	-	ENNIS	LOFT	AQUA

Soft Seating

Magog - Armchair

MAG

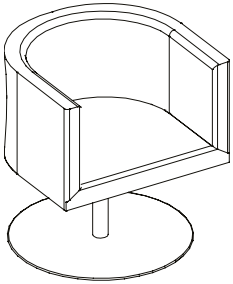

Manufacturing Standards

- 180° swivel armchair that returns to its initial position;
- Single top stitching;
- Medium-density foam;
- Circular base (24" diameter) with glides.

Combination of Colors

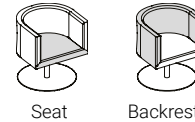

COM Fabrics: COM Fabrics are provided by the customer. For pricing please refer GR2 grade price.

Number of yards for COM fabric: [See Appendix B](#)

Code	Total	Seat	Backrest
MAG	4.25	1	3.25

Prices

Code	GRA	GR1	GR2	GR3	GR4	GR5	GR6	GR7	GR8	GR9	GR10	GR11	GR12	Cuir Leather
MAG SN	2582	2658	2760	2860	2987	3114	3240	3367	3492	3618	3745	3998	4252	4041
MAG BL	2582	2658	2760	2860	2987	3114	3240	3367	3492	3618	3745	3998	4252	4041
MAG CHR	3453	3528	3630	3730	3856	3983	4110	4236	4362	4489	4614	4868	5121	4910

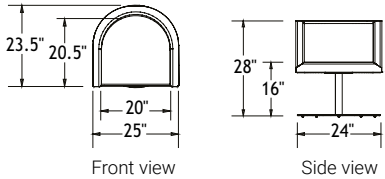

How to Order

LL		MAG		BL SN CHR	Fabric 1 (seat) <i>See the Logiflex Graded-in List</i>				Fabric 2 (backrest) <i>See the Logiflex Graded-in List</i>					
serie	code	base	supplier	pattern	color	supplier	pattern	color						
LL	-	MAG	-	CHR	-	ENNIS	LOFT	AQUA	-	ENNIS	LOFT	AQUA		

Soft Seating

Orford - Armchair

ORF

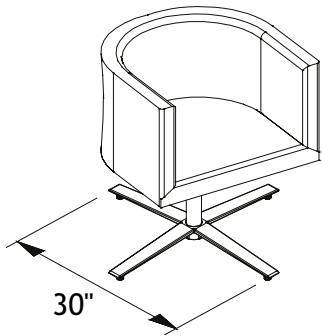

Manufacturing Standards

- 180° swivel armchair that returns to its initial position;
- Single top stitching;
- Medium-density foam;
- Aluminum base with glides;
- Footing dimension: 30" wide.

Combination of Colors

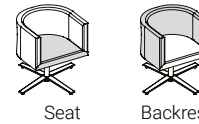

COM Fabrics: COM Fabrics are provided by the customer. For pricing please refer GR2 grade price.

Number of yards for COM fabric: [See Appendix B](#)

Code	Total	Seat	Backrest
ORF	4.25	1	3.25

Prices

Code	GRA	GR1	GR2	GR3	GR4	GR5	GR6	GR7	GR8	GR9	GR10	GR11	GR12	Cuir Leather
ORF SN	3234	3309	3411	3511	3638	3765	3891	4018	4144	4269	4396	4649	4903	4692
ORF BL	3234	3309	3411	3511	3638	3765	3891	4018	4144	4269	4396	4649	4903	4692
ORF CHR	3830	3906	4007	4108	4234	4361	4487	4613	4739	4866	4992	5246	5498	5287

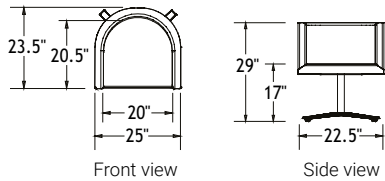

How to Order

LL		ORF		BL SN CHR	Fabric 1 (seat) <i>See the Logiflex Graded-in List</i>				Fabric 2 (backrest) <i>See the Logiflex Graded-in List</i>					
serie	code	base	supplier	pattern	color	supplier	pattern	color						
Example LL	-	ORF	-	CHR	-	ENNIS	LOFT	AQUA	-	ENNIS	LOFT	AQUA		

Soft Seating

Taylor - Armchair

TAY1

Armchair

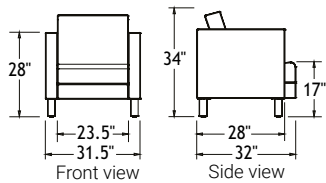
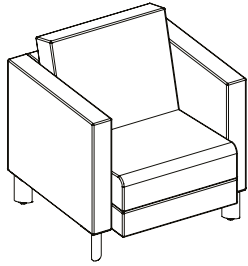

Combination of Colors

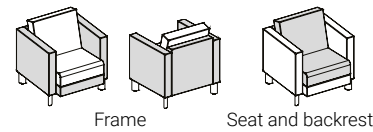

Manufacturing Standards

- Elastic straps on seat;
- Medium-density foam;
- Frame made out of recycled and recyclable particles;
- Oval metal legs 6" H, satin nickel finish.

COM Fabrics: COM Fabrics are provided by the customer. For pricing please refer GR2 grade price.

Number of yards for COM Fabric: [See Appendix B](#)

Code	Total	Frame	Seat and backrest
TAY1	5,75	3,75	2

Prices

Code	GRA	GR1	GR2	GR3	GR4	GR5	GR6	GR7	GR8	GR9	GR10	GR11	GR12	Cuir Leather
TAY1	1450	1521	1617	1712	1831	1950	2069	2188	2307	2426	2545	2783	3021	2823

How to Order

Fabric 1 (frame)
[See the Logiflex Graded-in List](#)

Fabric 2 (seat and backrest)
[See the Logiflex Graded-in List](#)

LL	-	TAY1	-				-			
serie		code		supplier	pattern	color		supplier	pattern	color

Example	LL	-	TAY1	-	ENNIS	LOFT	AQUA	-	ENNIS	LOFT	AQUA
----------------	----	---	------	---	-------	------	------	---	-------	------	------

Soft Seating

Taylor - Loveseat

TAY2

Loveseat

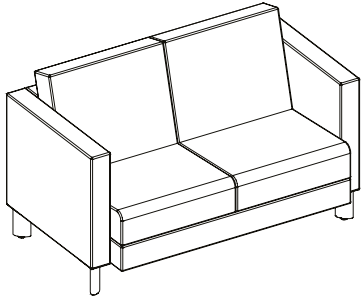

Combination of Colors

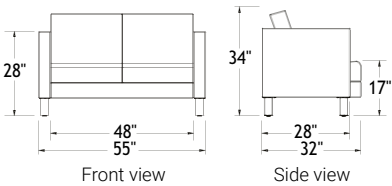
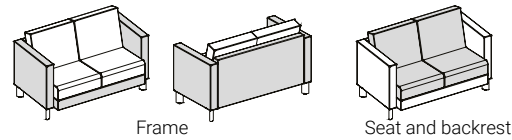

Manufacturing Standards

- Elastic straps on seat;
- Medium-density foam;
- Frame made out of recycled and recyclable particles;
- Oval metal legs 6" H, satin nickel finish.

COM Fabrics: COM Fabrics are provided by the customer. For pricing please refer GR2 grade price.

Number of yards for COM fabric: [See Appendix B](#)

Code	Total	Frame	Seat and backrest
TAY2	7	4	3

Prices

Code	GRA	GR1	GR2	GR3	GR4	GR5	GR6	GR7	GR8	GR9	GR10	GR11	GR12	Cuir Leather
TAY2	2020	2119	2250	2380	2544	2708	2872	3034	3198	3362	3526	3852	4180	3908

How to Order

Fabric 1 (frame)
[See the Logiflex Graded-in List](#)

Fabric 2 (seat and backrest)
[See the Logiflex Graded-in List](#)

LL	-	TAY2	-				-			
serie		code		supplier	pattern	color		supplier	pattern	color

Example LL - TAY2 - ENNIS LOFT AQUA - ENNIS LOFT AQUA

Soft Seating

Taylor - Sofa

TAY3

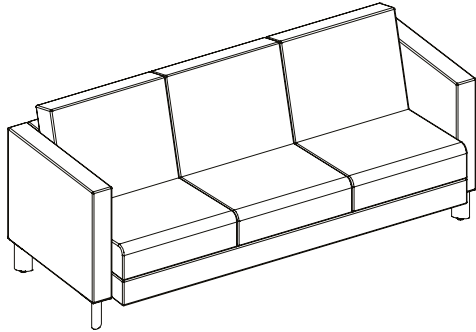

Combination of Colors

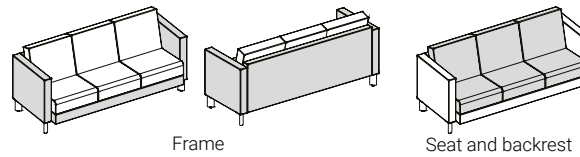

Frame

Seat and backrest

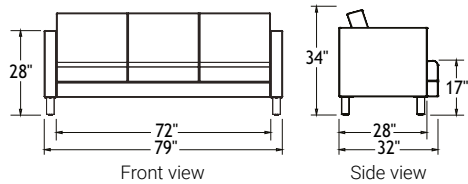

Front view

Side view

Manufacturing Standards

- Elastic straps on seat;
- Medium-density foam;
- Frame made out of recycled and recyclable particles;
- Oval metal legs 6" H, satin nickel finish.

COM Fabrics: COM Fabrics are provided by the customer. For pricing please refer GR2 grade price.

Number of yards for COM fabric: [See Appendix B](#)

Code	Total	Frame	Seat and backrest
TAY3	9,25	5	4,25

Prices

Code	GRA	GR1	GR2	GR3	GR4	GR5	GR6	GR7	GR8	GR9	GR10	GR11	GR12	Cuir Leather
TAY3	2657	2818	3032	3247	3515	3782	4050	4318	4586	4852	5121	5657	6191	5745

How to Order

Fabric 1 (frame)
See the Logiflex Graded-in List

Fabric 2 (seat and backrest)
See the Logiflex Graded-in List

LL	-	TAY3	-			-					
serie		code		supplier	pattern	color		supplier	pattern	color	

Example LL - TAY3 - ENNIS LOFT AQUA - ENNIS LOFT AQUA

Soft Seating

Slim - Lounge Armchair

SL1FC

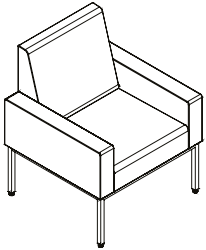

Manufacturing Standards

- Construction in laminated hardwood veneer and hardwood;
- Springs on seat covered with 2" foam and 1/2" polyester;
- Elastic straps on back covered with 1-1/2" foam and 1/2" polyester;
- Arms covered with 1" foam;
- Seating frame base with four 11" high legs in 1" square welded steel profile. On white nylon levelers;
- Single top stitching.

Metal finishes available in satin nickel (SN) and black (BL).

COM Fabrics: COM Fabrics are provided by the customer. For pricing please refer GR2 grade price.

Number of yards for COM fabric: [See Appendix B](#)

Code	Total (1 fabric)	Frame and seat	Backrest
SL1FC	3,1	2	1,6

Combination of Colors

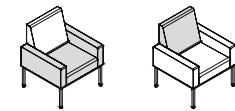

Frame and seat Backrest

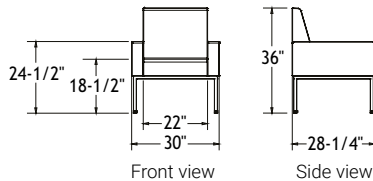

Prices

Code	GRA	GR1	GR2	GR3	GR4	GR5	GR6	GR7	GR8	GR9	GR10	GR11	GR12	Cuir Leather
SL1FC	2021	2075	2147	2219	2308	2397	2486	2575	2665	2753	2843	3022	3200	3051

How to Order

LL	-	SL1	-	FC	-	BL SN (std)	-	Fabric 1 (frame and seat) <i>See the Logiflex Graded-in List</i>			Fabric 2 (backrest) <i>See the Logiflex Graded-in List</i>					
serie		code		arms		metal finish (Appx. A)		supplier	pattern	color		supplier	pattern	color		
Example		LL	-	SL1	-	FC	-	SN	-	ENNIS	LOFT	AQUA	-	ENNIS	LOFT	AQUA

Soft Seating

Slim - Loveseat

SL2FC

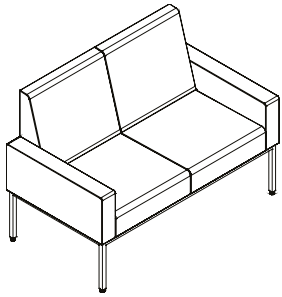

Manufacturing Standards

- Construction in laminated hardwood veneer and hardwood;
- Springs on seat covered with 2" foam and 1/2" polyester;
- Elastic straps on back covered with 1-1/2" foam and 1/2" polyester;
- Arms covered with 1" foam;
- Seating frame base with four 11" high legs in 1" square welded steel profile. On white nylon levelers;
- Single top stitching.

Metal finishes available in satin nickel (SN) and black (BL).

COM Fabrics: COM Fabrics are provided by the customer. For pricing please refer GR2 grade price.

Number of yards for COM fabric: [See Appendix B](#)

Code	Total (1 fabric)	Frame and seat	Backrest
SL2FC	4,5	2,7	2,3

Combination of Colors

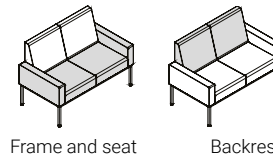

Frame and seat

Backrest

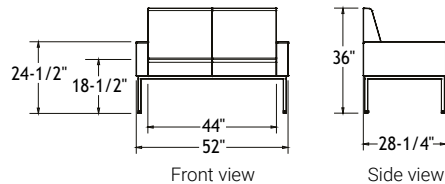

Prices

Code	GRA	GR1	GR2	GR3	GR4	GR5	GR6	GR7	GR8	GR9	GR10	GR11	GR12	Cuir Leather
SL2FC	2898	2983	3096	3208	3351	3491	3633	3775	3915	4057	4197	4481	4763	4527

How to Order

LL	-	SL2	-	FC	-	BL SN (std)	-	Fabric 1 (frame and seat) <i>See the Logiflex Graded-in List</i>			Fabric 2 (backrest) <i>See the Logiflex Graded-in List</i>					
serie		code		arms		metal finish (Appx. A)		supplier	pattern	color		supplier	pattern	color		
Example		LL	-	SL2	-	FC	-	SN	-	ENNIS	LOFT	AQUA	-	ENNIS	LOFT	AQUA

Soft Seating

Slim - Sofa

SL3FC

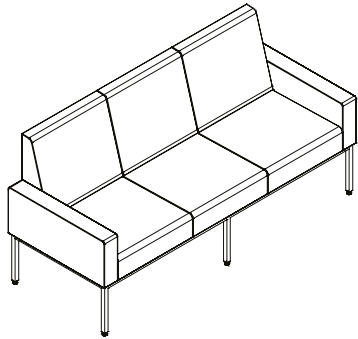

Manufacturing Standards

- Construction in laminated hardwood veneer and hardwood;
- Springs on seat covered with 2" foam and 1/2" polyester;
- Elastic straps on back covered with 1-1/2" foam and 1/2" polyester;
- Arms covered with 1" foam;
- Seating frame base with six 11" high legs in 1" square welded steel profile. On white nylon levelers;
- Single top stitching.

Metal finishes available in satin nickel (SN) and black (BL).

COM Fabrics: COM Fabrics are provided by the customer. For pricing please refer GR2 grade price.

Number of yards for COM fabric: [See Appendix B](#)

Code	Total (1 fabric)	Frame and seat	Backrest
SL3FC	6,1	3,7	3,2

Combination of Colors

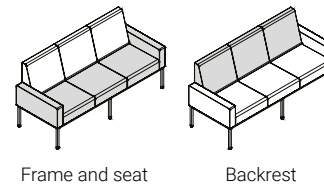

Frame and seat

Backrest

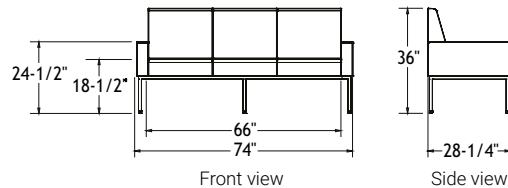

Prices

Code	GRA	GR1	GR2	GR3	GR4	GR5	GR6	GR7	GR8	GR9	GR10	GR11	GR12	Cuir Leather
SL3FC	3727	3852	4019	4186	4394	4602	4810	5018	5227	5434	5643	6059	6476	6129

How to Order

LL	-	SL3	-	FC	-	BL SN (std)	-	Fabric 1 (frame and seat) <i>See the Logiflex Graded-in List</i>			Fabric 2 (backrest) <i>See the Logiflex Graded-in List</i>					
serie		code		arms		metal finish (Appx. A)		supplier	pattern	color		supplier	pattern	color		
Example		LL	-	SL3	-	FC	-	SN	-	ENNIS	LOFT	AQUA	-	ENNIS	LOFT	AQUA

Soft Seating

Slim - Lounge Chair

SL1NA

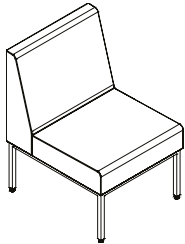

Manufacturing Standards

- Construction in laminated hardwood veneer and hardwood;
- Springs on seat covered with 2" foam and 1/2" polyester;
- Elastic straps on back covered with 1-1/2" foam and 1/2" polyester;
- Seating frame base with four 11" high legs in 1" square welded steel profile. On white nylon levelers;
- Single top stitching.

Metal finishes available in satin nickel (SN) and black (BL).

COM Fabrics: COM Fabrics are provided by the customer. For pricing please refer GR2 grade price.

Number of yards for COM fabric: [See Appendix B](#)

Code	Total (1 fabric)	Seat	Backrest
SL1NA	1,9	1	1,6

Combination of Colors

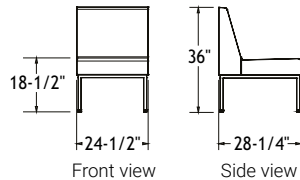
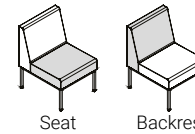

Code	GRA	GR1	GR2	GR3	GR4	GR5	GR6	GR7	GR8	GR9	GR10	GR11	GR12	Cuir Leather
SL1NA	1629	1666	1713	1760	1820	1880	1939	1998	2058	2118	2177	2296	2415	2315

How to Order

LL	-	SL1	-	NA	-	BL SN (std)	-	Fabric 1 (seat) See the Logiflex Graded-in List			Fabric 2 (backrest) See the Logiflex Graded-in List					
serie		code		arms		metal finish (Appx. A)		supplier	pattern	color		supplier	pattern	color		
Example		LL	-	SL1	-	NA	-	SN	-	ENNIS	LOFT	AQUA	-	ENNIS	LOFT	AQUA

Soft Seating

Slim - Armless Loveseat

SL2NA

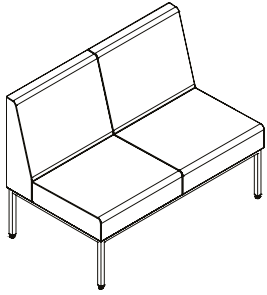

Combination of Colors

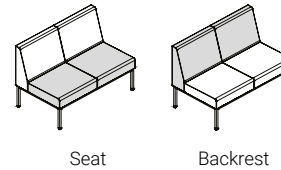

Manufacturing Standards

- Construction in laminated hardwood veneer and hardwood;
- Springs on seat covered with 2" foam and 1/2" polyester;
- Elastic straps on back covered with 1-1/2" foam and 1/2" polyester;
- Seating frame base with four 11" high legs in 1" square welded steel profile. On white nylon levelers;
- Single top stitching.

Metal finishes available in satin nickel (SN) and black (BL).

COM Fabrics: COM Fabrics are provided by the customer. For pricing please refer GR2 grade price.

Number of yards for COM fabric: [See Appendix B](#)

Code	Total (1 fabric)	Seat	Backrest
SL2NA	2,8	1,4	2,3

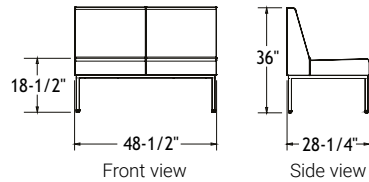

Code	GRA	GR1	GR2	GR3	GR4	GR5	GR6	GR7	GR8	GR9	GR10	GR11	GR12	Cuir Leather
SL2NA	2478	2536	2614	2690	2787	2884	2981	3078	3174	3270	3368	3561	3754	3593

How to Order

LL	-	SL2	-	NA	-	BL SN (std)	-	Fabric 1 (seat) <i>See the Logiflex Graded-in List</i>			Fabric 2 (backrest) <i>See the Logiflex Graded-in List</i>				
serie		code		arms		metal finish (Appx. A)		supplier	pattern	color		supplier	pattern	color	
Example	LL	-	SL2	-	NA	-	SN	-	ENNIS	LOFT	AQUA	-	ENNIS	LOFT	AQUA

Soft Seating

Slim - Armless Sofa

SL3NA

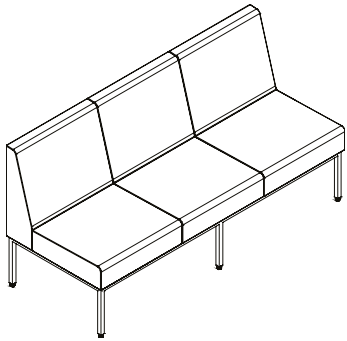

Combination of Colors

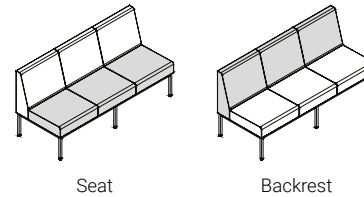

Seat

Backrest

Manufacturing Standards

- Construction in laminated hardwood veneer and hardwood;
- Springs on seat covered with 2" foam and 1/2" polyester;
- Elastic straps on back covered with 1-1/2" foam and 1/2" polyester;
- Seating frame base with six 11" high legs in 1" square welded steel profile. On white nylon levelers;
- Single top stitching.

Metal finishes available in satin nickel (SN) and black (BL).

COM Fabrics: COM Fabrics are provided by the customer. For pricing please refer GR2 grade price.

Number of yards for COM fabric: [See Appendix B](#)

Code	Total (1 fabric)	Seat	Backrest
SL3NA	4,9	2	3,1

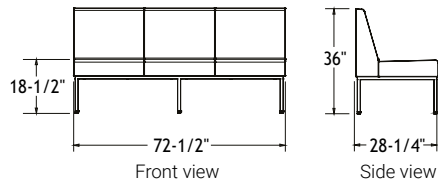

Prices

Code	GRA	GR1	GR2	GR3	GR4	GR5	GR6	GR7	GR8	GR9	GR10	GR11	GR12	Cuir Leather
SL3NA	3354	3453	3583	3714	3877	4042	4204	4368	4532	4696	4860	5186	5514	5241

How to Order

LL	-	SL3	-	NA	-	BL SN (std)	-	Fabric 1 (seat) See the Logiflex Graded-in List			Fabric 2 (backrest) See the Logiflex Graded-in List					
serie		code		arms		metal finish (Appx. A)		supplier	pattern	color		supplier	pattern	color		
Example		LL	-	SL3	-	NA	-	SN	-	ENNIS	LOFT	AQUA	-	ENNIS	LOFT	AQUA

Soft Seating

Slim - Small Coffee Table

SL1T

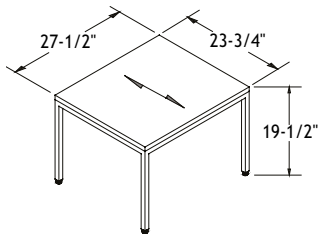

Manufacturing Standards

- 1" rectangular laminate top;
- Table frame base with four 18" high legs in 1" square welded steel profile.
- On white nylon levelers;
- Height: 19.5".

Metal finishes available in satin nickel (SN) and black (BL).

Prices

Code	
SL1T	615

How to Order

OS	SL1T	BL SN (std)
series	code	metal finish (Appx. A)

Example OS SL1T SN

Soft Seating

Slim - Large Coffee Table

SL2T

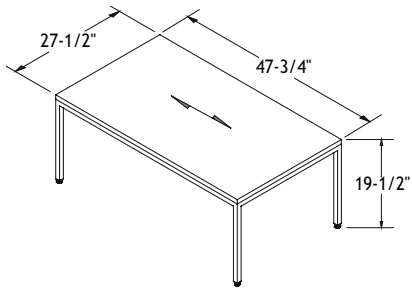

Manufacturing Standards

- 1" rectangular laminate top;
- Table frame base with four 18" high legs in 1" square welded steel profile.
- On white nylon levelers;
- Height: 19.5".

Metal finishes available in satin nickel (SN) and black (BL).

Prices

Code	
SL2T	771

How to Order

		BL SN (std)
OS	SL2T	
series	code	metal finish (Appx. A)

Example OS SL2T SN

Chairs

Appendix - MADRID - Options

Back Height



L Low back



M Medium back

Structure

UW wooden shell with seat cushion

UU fully upholstered chair

WW wooden shell

US HPL shell with seat cushion

SS HPL shell

Base



04 4 legs



T424 Stool 24"H
T429 Stool 29"H

Legs

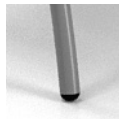

G Glides

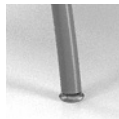

T Teflon glide
\$40

Metal



BL Black



CHR Chrome

Wood



GW Golden Wheat

HPL



W Polar White



B Jet Black

Chairs

Madrid - Visitor Chair (18,75"H) for Desk Height (29"H) - Wood or Upholstered

MD - MUW

MD - MUU

MD - MWW

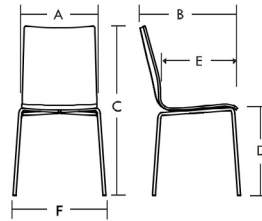
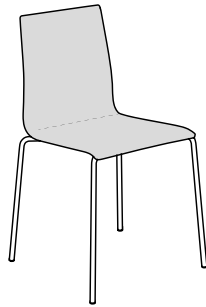

A Backrest width	15,75"
B Chair depth	20,5"
C Chair height	35"
D Seat height	18,75"
E Seat depth	16,5"
F Chair width	19,5"

Manufacturing Standards

Madrid chair:

- Wooden shell, golden wheat finish (GW),
 - MD-MUW: wooden shell with seat cushion;
 - MD-MUU: fully upholstered chair;
 - MD-MWW: wooden shell;
- Metal base with 4 legs, Black (BL) or Chrome (CHR) finish,
- Base on glides:
 - glides (G) or Teflon glides (T)
- Stackable up to 10 (using a trolley);
- Weight and volume (for 3 chairs): 35 lbs / 16 ft³;
- Use with a 29"H top;
- Maximum weight capacity: 250lbs.

SFP option: Plastic protector fixed under the seat to protect the fabric when the chairs are stacked.

Compatible with the **XO-10** trolley for stacking chairs.

Fabric finishes: Selection of fabrics or vinyl by the customer from the supplier of their choice.

COM Fabrics: COM Fabrics are provided by the customer. For pricing please refer to the GR2 grade price.

Number of yards for COM fabric:

[See Appendix B](#)

Code	Total
UW	0,62
UU	1,5

Options

Protector



SFP
\$30

Legs



G \$0 T \$40

Prices

MD

Code	GRA	GR1	GR2	GR3	GR4	GR5	GR6	GR7	GR8	GR9	GR10	GR11	GR12	Cuir Leather
UW	692	703	714	722	733	746	759	769	782	795	808	831	856	794
UU	713	739	771	806	848	890	932	973	1017	1058	1099	1186	1269	1243

MD - Wood

Code	
WW	588

How to Order

Combination of Colors

Fabrics
[See the fabric chart](#)
[Logiflex grade](#)

LC	MD	M	UW UU WW	04	G T	BL CHR	GW	Supplier	Pattern	Color	SFP	
serie	code	Back height	Structure	Base	Legs	Metal finish	Wood finish				Protector	
Example	LC	MD	M	UW	04	G	BL	GW	ENNIS	LOFT	AQUA	SFP

Chairs

Madrid - Visitor Chair (18,75"H) for Desk Height (29"H) - HPL

MD - MUS

MD - MSS

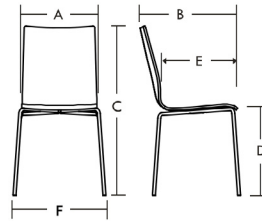
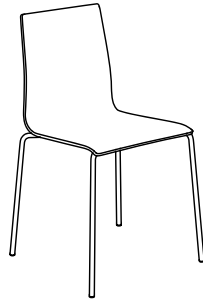

A Backrest width	15,75"
B Chair depth	20,5"
C Chair height	35"
D Seat height	18,75"
E Seat depth	16,5"
F Chair width	19,5"

Manufacturing Standards

Madrid chair:

- HPL shell, Intense Black (B) or Polar White (W) finish,
 - MD-MUS: HPL shell with seat cushion
 - MD-MSS: HPL shell
- Metal base with 4 legs, Black (BL) or Chrome (CHR) finish,
- Base on glides:
 - glides (G) or Teflon glides (T)
- Stackable up to 10 (using a trolley);
- Weight and volume (for 3 chairs): 35 lbs / 16 ft³;
- Use with a 29"H top;
- Maximum weight capacity: 250lbs.

SFP option: Plastic protector fixed under the seat to protect the fabric when the chairs are stacked.

Compatible with the **XO-10** trolley for stacking chairs.

Fabric finishes: Selection of fabrics or vinyl by the customer from the supplier of their choice.

COM Fabrics: COM Fabrics are provided by the customer. For pricing please refer GR2 grade price.

Number of yards for COM fabric: [See Appendix B](#)

Code	Total
US	0,62

Options

Protector



SFP
\$30

Chair options



See [Appendix Madrid](#) for complete options

Prices

MD

Code	GRA	GR1	GR2	GR3	GR4	GR5	GR6	GR7	GR8	GR9	GR10	GR11	GR12	Cuir Leather
US	817	829	837	848	860	872	884	897	907	920	933	956	983	919

MD - HPL

Code
SS
714

How to Order

Combination of Colors

Fabrics
[See the fabric chart](#)
[Logiflex grade](#)

LC	MD	M	US SS	04	G T	BL CHR	W B	Supplier	Pattern	Color	SFP
serie	code	Back height	Structure	Base	Legs	Metal finish	HPL finish	supplier	pattern	color	Protector

Example LC - MD - M - SS - 04 - G - BL - W - ENNIS - LOFT - AQUA - SFP

Chairs

Madrid - Stool (24"H) for Counter Height (36"H) - Wood or Upholstered

MD - LUW

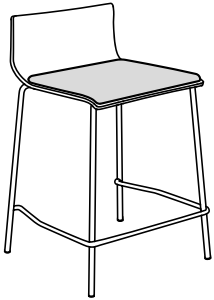

MD - LUU

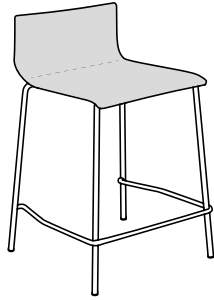

MD - LWW

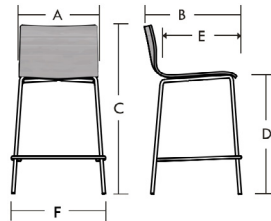
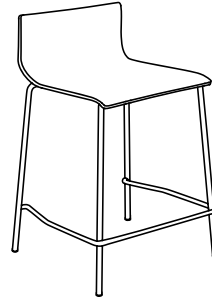

A Backrest width	15,75"
B Chair depth	18,75"
C Chair height	33,5"
D Seat height	24"
E Seat depth	16"
F Chair width	19,5"

Manufacturing Standards

Madrid stool, counter height (24"H):

- Wooden shell, golden wheat finish (GW),
 - MD-LUW: wooden shell with seat cushion
 - MD-LUU: fully upholstered chair;
 - MD-LWW: wooden shell
- Metal base with 4 legs, Black (BL) or Chrome (CHR) finish,
- Base on glides:
 - glides (G) or Teflon glides (T)
- Weight and volume (for 3 chairs): 25 lbs / 8 ft³;
- Use with a 36"H top;
- Maximum weight capacity: 250lbs.

Fabric finishes: Selection of fabrics or vinyl by the customer from the supplier of their choice.

COM Fabrics: COM Fabrics are provided by the customer. For pricing please refer GR2 grade price.

Number of yards for COM fabric: [See Appendix B](#)

Code	Total
UW	0,62
UU	1,2

Options

Chair options



See [Appendix Madrid](#) for complete options

Prices

MD

Code	GRA	GR1	GR2	GR3	GR4	GR5	GR6	GR7	GR8	GR9	GR10	GR11	GR12	Cuir Leather
UW	958	966	977	987	998	1011	1023	1035	1046	1061	1072	1096	1122	1060
UU	909	928	955	983	1016	1046	1079	1113	1146	1179	1213	1279	1346	1378

MD - Wood

Code	
WW	853

How to Order

Combination of Colors

Fabrics
See the fabric chart
Logiflex grade

LC	-	MD	-	L	-	T424	-	G	-	BL	-	GW	-						
serie		code		Back height		Base		Legs		Metal finish		Wood finish		supplier	pattern	color			
Example	LC	-	MD	-	L	-	UW	-	T424	-	G	-	BL	-	GW	-	ENNIS	LOFT	AQUA

Chairs

Madrid - Stool (29"H) for Bar Height (42"H) - Wood or upholstered

MD - LUW

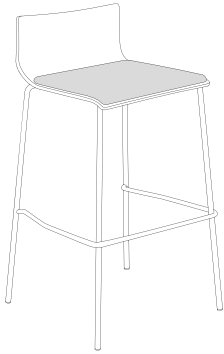

MD - LUU

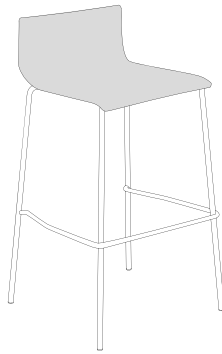

MD - LWW

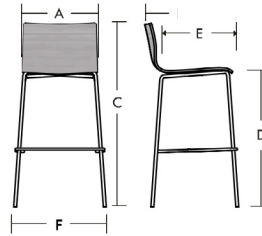
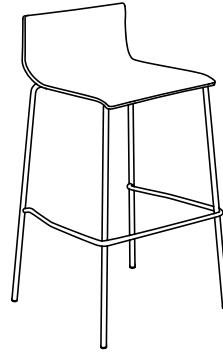

A Backrest width	15,75"
B Chair depth	18,75"
C Chair height	38,5"
D Seat height	29"
E Seat depth	16"
F Chair width	19,5"

Manufacturing Standards

Madrid stool, bar height (29"H):

- Wooden shell, golden wheat finish (GW),
 - MD-LUW: wooden shell with seat cushion
 - MD-LUU: fully upholstered chair;
 - MD-LWW: wooden shell
- Metal base with 4 legs, Black (BL) or Chrome (CHR) finish,
- Base on glides:
 - glides (G) or Teflon glides (T)
- Weight and volume (for 3 chairs): 25 lbs / 8 ft³;
- Use with a 42"H top;
- Maximum weight capacity: 250lbs.

Fabric finishes: Selection of fabrics or vinyl by the customer from the supplier of their choice.

COM Fabrics: COM Fabrics are provided by the customer. For pricing please refer GR2 grade price.

Number of yards for COM fabric: [See Appendix B](#)

Code	Total
UW	0,62
UU	1,2

Options

Chair options



See [Appendix Madrid](#) for complete options

Prices

MD

Code	GRA	GR1	GR2	GR3	GR4	GR5	GR6	GR7	GR8	GR9	GR10	GR11	GR12	Cuir Leather
UW	958	966	977	987	998	1011	1023	1035	1046	1061	1072	1096	1122	1060
UU	909	928	955	983	1016	1046	1079	1113	1146	1179	1213	1279	1346	1378

MD - Wood

Code	
WW	853

How to Order

Combination of Colors

Fabrics
See the fabric chart
Logiflex grade

LC	-	MD	-	L	-	T429	-	G	-	BL	-	GW	-			
serie		code		Back height		Base		Legs		Metal finish		Wood finish		supplier	pattern	color
UU		UU		UU		UU		UU		UU		UU		UU		UU

Example LC - MD - L - UW - T429 - G - BL - GW - ENNIS - LOFT - AQUA

Chairs

Madrid - Stool (24"H) for Counter Height (36"H) - HPL

MD - LUS

MD - LSS

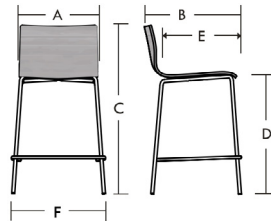
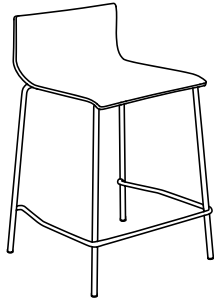
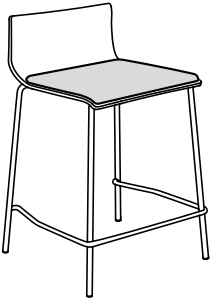

A Backrest width	15,75"
B Chair depth	18,75"
C Chair height	33,5"
D Seat height	24"
E Seat depth	16"
F Chair width	19,5"

Manufacturing Standards

Madrid stool, counter height (24"H):

- HPL shell, Intense Black (B) or Polar White (W) finish,
 - MD-LUS: HPL shell with seat cushion
 - MD-LSS: HPL shell
- Metal base with 4 legs, Black (BL) or Chrome (CHR) finish,
- Base on glides:
 - glides (G) or Teflon glides (T)
- Weight and volume (for 3 chairs): 25 lbs / 8 ft³;
- Use with a 36"H top;
- Maximum weight capacity: 250lbs.

Fabric finishes: Selection of fabrics or vinyl by the customer from the supplier of their choice.

COM Fabrics: COM Fabrics are provided by the customer. For pricing please refer GR2 grade price.

Number of yards for COM fabric: [See Appendix B](#)

Code	Total
US	0,62

Options

Chair options



See [Appendix Madrid](#) for complete options

Prices

MD

Code	GRA	GR1	GR2	GR3	GR4	GR5	GR6	GR7	GR8	GR9	GR10	GR11	GR12	Cuir Leather
US	1074	1087	1096	1103	1119	1129	1142	1154	1166	1177	1192	1213	1239	1176

MD - HPL

Code	
SS	971

How to Order

Combination of Colors

Fabrics
See the fabric chart
Logiflex grade

LC	-	MD	-	L	US	-	T424	-	G	-	BL	-	W	-			
serie		code		Back height	Structure		Base		Legs		Metal finish		HPL finish		supplier	pattern	color
					SS				T		CHR		B				

Example

LC	-	MD	-	L	SS	-	T424	-	G	-	BL	-	W	-	ENNIS	LOFT	AQUA

Chairs

Madrid - Stool (29"H) for Bar Height (42"H) - HPL

MD - LUS

MD - LSS

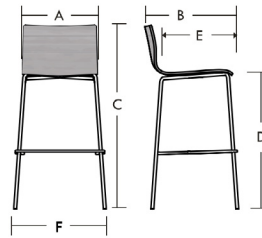
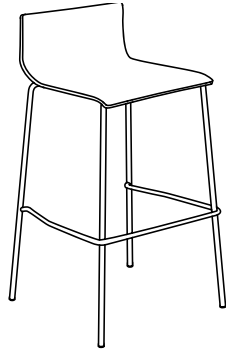
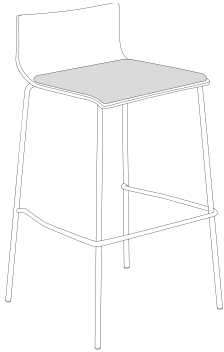

A Backrest width	15,75"
B Chair depth	18,75"
C Chair height	38,5"
D Seat height	29"
E Seat depth	16"
F Chair width	19,5"

Manufacturing Standards

Madrid stool, bar height (29"H):

- HPL shell, Intense Black (B) or Polar White (W) finish,
 - MD-LUS: HPL shell with seat cushion
 - MD-LSS: HPL shell
- Metal base with 4 legs, Black (BL) or Chrome (CHR) finish,
- Base on glides:
 - glides (G) or Teflon glides (T)
- Weight and volume (for 3 chairs): 25 lbs / 8 ft³;
- Use with a 42"H top;
- Maximum weight capacity: 250lbs.

Fabric finishes: Selection of fabrics or vinyl by the customer from the supplier of their choice.

COM Fabrics: COM Fabrics are provided by the customer. For pricing please refer GR2 grade price.

Number of yards for COM fabric: [See Appendix B](#)

Code	Total
US	0,62

Options

Chair options



See [Appendix Madrid](#) for complete options

Prices

MD

Code	GRA	GR1	GR2	GR3	GR4	GR5	GR6	GR7	GR8	GR9	GR10	GR11	GR12	Cuir Leather
US	1074	1087	1096	1103	1119	1129	1142	1154	1166	1177	1192	1213	1239	1176

MD - HPL

Code	
SS	971

How to Order

Combination of Colors

Fabrics
See the fabric chart
Logiflex grade

LC	-	MD	-	L	US	-	T429	-	G	-	BL	-	W	-	supplier	pattern	color
serie		code		Back height	Structure		Base		Legs		Metal finish		HPL finish				
					SS				T		CHR		B				

Example

LC	-	MD	-	L	SS	-	T429	-	G	-	BL	-	W	-	ENNIS	LOFT	AQUA

Chairs



Cart (Madrid - Stack6)

MD-10

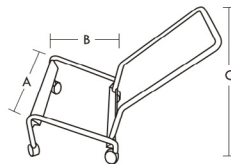
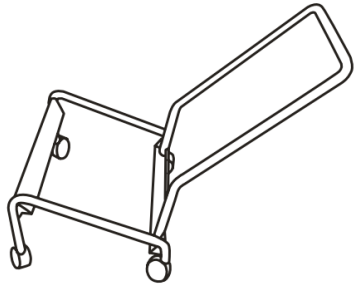

A Chair width	20"
B Chair depth	25"
C Chair height	36"

Manufacturing Standards

Cart (Madrid, Stack6) :

- Cart for stacking chairs;
- Silver painted steel with handle;
- Black casters with brakes;
- 10 stacked chair capacity.

Prices

Code	
MD-10	519

How to Order

LC	MD-10
serie	code

Example **LC** **MD-10**

Chairs

Sedia

SD

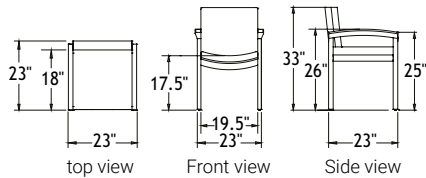
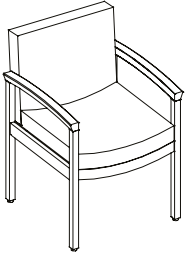

Combination of Colors
 Request a quotation for the combination with 2 colors.

Manufacturing Standards

- Single top stitching;
- Elastic straps on seat and back;
- Medium-density foam on seat;
- Low density foam on back;
- Frame made out of hardwood;
- Maximum weight capacity: 250lbs.

Wood finishes: Available colors: White Wash WW, Golden Wheat GW, Sand SD, Apricot AT, Pecan PN, Brandy BR, Chestnut CT, Coffee CF, Espresso ES, Bordeaux BO, Black Wash BW and Bark BK.

COM Fabrics: COM Fabrics are provided by the customer. For pricing please refer GR2 grade price.

Number of yards for COM fabric: [See Appendix B](#)

Code	Total
SD	2

Prices

Code	GRA	GR1	GR2	GR3	GR4	GR5	GR6	GR7	GR8	GR9	GR10	GR11	GR12	Cuir Leather
SD	1130	1166	1213	1261	1320	1380	1440	1499	1558	1618	1678	1796	1916	1816

How to Order

Finishes
 See the Logiflex Color Guide

Fabrics
 See the Logiflex Graded-in List

LL	-	SD	-	-			
serie		code		base	supplier	pattern	color

Example

LL	-	SD	-	BO	-	ENNIS	LOFT	AQUA
----	---	----	---	----	---	-------	------	------

Chairs

Milan Bold - Armchair with Plywood Back

BAC

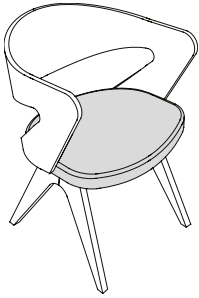

BACC

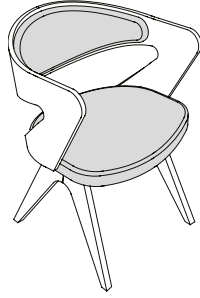

Note: The upholstered back cushion cannot be in vinyl or leather. It is also not recommended to use a pattern fabric on the upholstered back cushion.

Combination of Colors



Seat Backrest

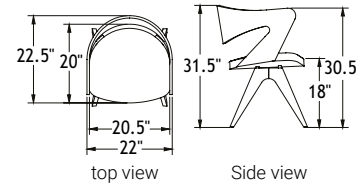

Manufacturing Standards

- Back construction in laminated hardwood veneer;
- Upholstered seat with single top stitching;
- Legs in hardwood;
- **BACC:** cushion added to backrest.

Wood finishes: Available colors: White Wash WW, Golden Wheat GW, Sand SD, Apricot AT, Pecan PN, Brandy BR, Chestnut CT, Coffee CF, Espresso ES, Bordeaux BO, Black Wash BW and Bark BK.

COM Fabrics: COM Fabrics are provided by the customer. For pricing please refer GR2 grade price.

Number of yards for COM fabric: [See Appendix B](#)

Code	Total	Seat	Backrest
BAC	.75	.75	-
BACC	1.25	.75	.5

Options

Legs



Prices

Code	GRA	GR1	GR2	GR3	GR4	GR5	GR6	GR7	GR8	GR9	GR10	GR11	GR12	Cuir Leather
BAC	1319	1333	1350	1368	1391	1412	1435	1457	1479	1502	1523	1570	1614	1577
BACC	1407	1430	1461	1489	1526	1564	1601	1639	1675	1712	1750	1823	1898	1836

How to Order

						S B		Finishes See the Logiflex Color Guide			Fabric 1 (seat) See the Logiflex Graded-in List						
LL	-	MN	-	BAC	-												
serie		code		legs		leg color		back color		supplier		pattern		color			
Example	LL	-	MN	-	BAC	-	SN	-	GW	-	GW	-	ENNIS	LOFT	AQUA		
						S B		Finishes See the Logiflex Color Guide			Fabric 1 (seat) See the Logiflex Graded-in List			Fabric 1 (backrest) See the Logiflex Graded-in List			
LL	-	MN	-	BACC	-												
serie		code		legs		leg color		back color		supplier		pattern		color		supplier pattern color	
Example	LL	-	MN	-	BACC	-	SN	-	GW	-	GW	-	ENNIS	LOFT	AQUA	-	ENNIS LOFT AQUA

Chairs

Milan - Armchair with Plywood Back

AC

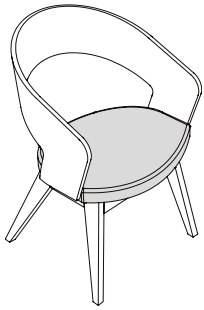

ACC

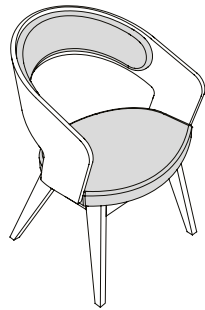

Note: The upholstered back cushion cannot be in vinyl or leather. It is also not recommended to use a pattern fabric on the upholstered back cushion.

Combination of Colors



Seat Backrest

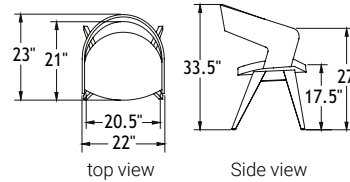

top view

Side view

Manufacturing Standards

- Back construction in laminated hardwood veneer;
- Upholstered seat with single top stitching;
- Straight legs in hardwood;
- **ACC:** cushion added to backrest.

Wood finishes: Available colors: White Wash WW, Golden Wheat GW, Sand SD, Apricot AT, Pecan PN, Brandy BR, Chestnut CT, Coffee CF, Espresso ES, Bordeaux BO, Black Wash BW and Bark BK.

COM Fabrics: COM Fabrics are provided by the customer. For pricing please refer GR2 grade price.

Number of yards for COM fabric: [See Appendix B](#)

Code	Total	Seat	Backrest
AC	.75	.75	-
ACC	1	.75	.5

Options

Legs

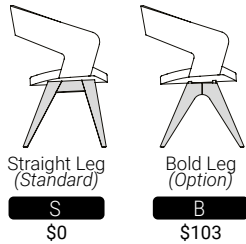

Straight Leg (Standard)

Bold Leg (Option)

S \$0

B \$103

Prices

Code	GRA	GR1	GR2	GR3	GR4	GR5	GR6	GR7	GR8	GR9	GR10	GR11	GR12	Cuir Leather
AC	1312	1325	1343	1361	1383	1405	1428	1450	1472	1495	1516	1561	1606	1570
ACC	1406	1424	1448	1472	1502	1532	1561	1591	1621	1650	1681	1740	1799	1750



						S B		Finishes See the Logiflex Color Guide			Fabric 1 (seat) See the Logiflex Graded-in List			Fabric 1 (backrest) See the Logiflex Graded-in List					
LL	-	MN	-	AC	-	-	-	-	-	-	-	-	-	-	-	-	-		
serie		code		legs		leg color		back color		supplier		pattern		color					
Example	LL	-	MN	-	AC	-	SN	-	GW	-	GW	-	ENNIS	LOFT	AQUA				
						S B		Finishes See the Logiflex Color Guide			Fabric 1 (seat) See the Logiflex Graded-in List			Fabric 1 (backrest) See the Logiflex Graded-in List					
LL	-	MN	-	ACC	-	-	-	-	-	-	-	-	-	-	-	-	-		
serie		code		legs		leg color		back color		supplier		pattern		color		supplier			
Example	LL	-	MN	-	ACC	-	SN	-	GW	-	GW	-	ENNIS	LOFT	AQUA	-	ENNIS	LOFT	AQUA

Chairs

Milan - Armchair with Upholstered Back

ACU

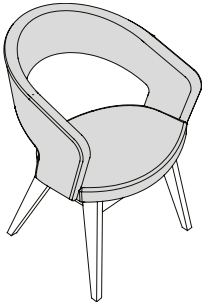

Note: The upholstered back cushion cannot be in vinyl or leather. It is also not recommended to use a pattern fabric on the upholstered back cushion.

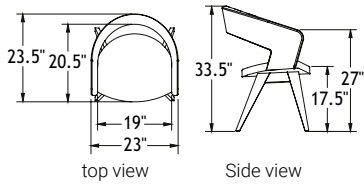

Combination of Colors

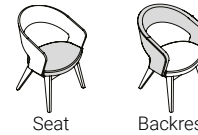

Manufacturing Standards

- Upholstered back with single top stitching;
- Upholstered seat with single top stitching;
- Straight legs in hardwood.

Wood finishes: Available colors: White Wash WW, Golden Wheat GW, Sand SD, Apricot AT, Pecan PN, Brandy BR, Chestnut CT, Coffee CF, Espresso ES, Bordeaux BO, Black Wash BW and Bark BK.

COM Fabrics: COM Fabrics are provided by the customer. For pricing please refer GR2 grade price.

Number of yards for COM fabric: [See Appendix B](#)

Code	Total	Seat	Backrest
ACU	2	.5	1.5

Options

Legs

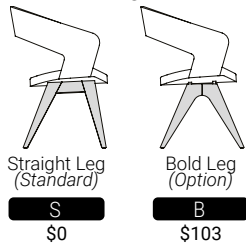

Prices

Code	GRA	GR1	GR2	GR3	GR4	GR5	GR6	GR7	GR8	GR9	GR10	GR11	GR12	Cuir Leather
ACU	1321	1358	1405	1452	1512	1572	1630	1690	1750	1810	1868	1988	2106	2007

How to Order

						+											
						S B	Finishes See the Logiflex Color Guide	Fabric 1 (seat) See the Logiflex Graded-in List					Fabric 1 (backrest) See the Logiflex Graded-in List				
LL	-	MN	-	ACU	-												
serie				code		legs		leg color			supplier		pattern			color	
Example	LL	-	MN	-	ACU	-	SN	-	GW	-	ENNIS	LOFT	AQUA	-	ENNIS	LOFT	AQUA

Chairs

Milan - Chair with Plywood Back

CH

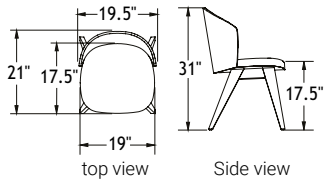
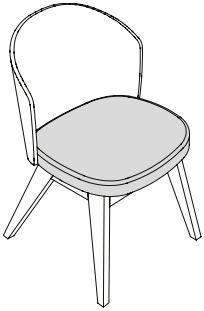

Manufacturing Standards

- Back construction in laminated hardwood veneer;
- Upholstered seat with single top stitching;
- Straight legs in hardwood.

Wood finishes: Available colors: White Wash WW, Golden Wheat GW, Sand SD, Apricot AT, Pecan PN, Brandy BR, Chestnut CT, Coffee CF, Espresso ES, Bordeaux BO, Black Wash BW and Bark BK.

COM Fabrics: COM Fabrics are provided by the customer. For pricing please refer GR2 grade price.

Number of yards for COM fabric: [See Appendix B](#)

Code	Total
CH	.75

Options

Legs

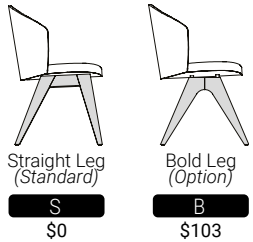

Prices

Code	GRA	GR1	GR2	GR3	GR4	GR5	GR6	GR7	GR8	GR9	GR10	GR11	GR12	Cuir Leather
CH	1107	1121	1139	1156	1179	1201	1224	1246	1268	1291	1312	1358	1402	1365

How to Order

						+		Finishes See the Logiflex Color Guide			Fabric 1 (seat) See the Logiflex Graded-in List				
LL	-	MN	-	CH	-	S	B								
serie				code		legs		leg color		back color		supplier	pattern	color	
Example	LL	-	MN	-	CH	-	SN	-	GW	-	GW	-	ENNIS	LOFT	AQUA

Chairs

Milan - Chair with Upholstered Back

CHU

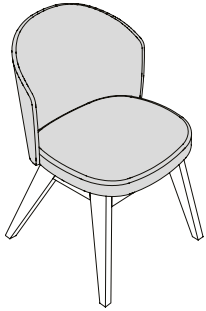

Note: The upholstered back cushion cannot be in vinyl or leather. It is also not recommended to use a pattern fabric on the upholstered back cushion.

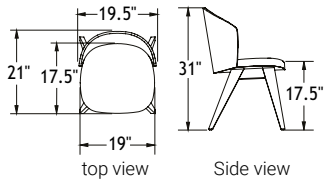

Combination of Colors

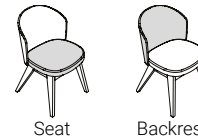

Manufacturing Standards

- Upholstered back with single top stitching;
- Upholstered seat with single top stitching;
- Straight legs in hardwood.

Wood finishes: Available colors: White Wash WW, Golden Wheat GW, Sand SD, Apricot AT, Pecan PN, Brandy BR, Chestnut CT, Coffee CF, Espresso ES, Bordeaux BO, Black Wash BW and Bark BK.

COM Fabrics: COM Fabrics are provided by the customer. For pricing please refer GR2 grade price.

Number of yards for COM fabric: [See Appendix B](#)

Code	Total	Seat	Backrest
CHU	1.5	.75	1.25

Options

Legs

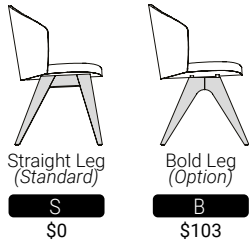

Prices

Code	GRA	GR1	GR2	GR3	GR4	GR5	GR6	GR7	GR8	GR9	GR10	GR11	GR12	Cuir Leather
CHU	1177	1205	1240	1276	1320	1366	1410	1454	1499	1544	1588	1678	1767	1692

How to Order

						+	S B	Finishes See the Logiflex Color Guide	Fabric 1 (seat) See the Logiflex Graded-in List				Fabric 1 (backrest) See the Logiflex Graded-in List				
LL	-	MN	-	CHU	-												
serie				code		legs		leg color		supplier		pattern		color			
Example	LL	-	MN	-	CHU	-	SN	-	GW	-	ENNIS	LOFT	AQUA	-	ENNIS	LOFT	AQUA

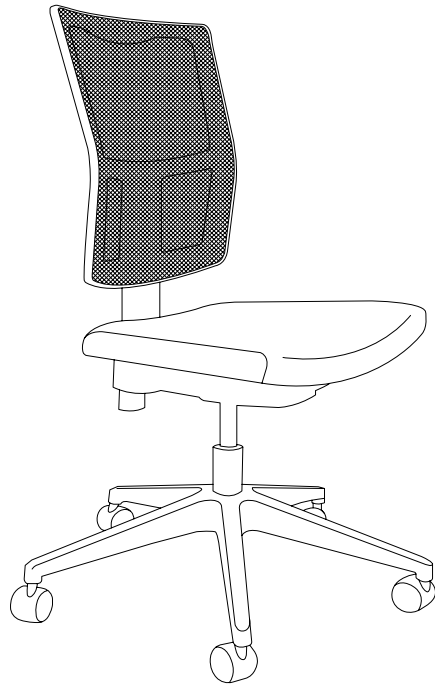

Cyrus Task Seating

This chair is designed with sleek lines, so it fits well in any setting. With a medium fabric mesh backrest, the Cyrus is your go-anywhere chair.

Task Seating

Appendix - CYRUS - Options

Chair bases



VN Black nylon tapered base



ZN Black nylon rounded base



VC Aluminum tapered base
\$174



ZC Aluminum rounded base
\$174



01 Sled base

Mecanism

Mecanism 41
\$60

Arms



NA
• No arms



F7 Fixed Aluminum arms
\$307

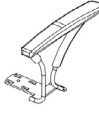

F61 Fixed T shaped arms
\$150



FD Closed fixed arms
\$150



FG Open fixed arms
\$150

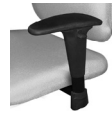

AD Adjustable arms
\$150



AS Adjustable arms
\$150



AZ Adjustable arms with multi-axis
and pivot armrests
\$307



FZ Fixed arms
\$307

Legs



H Casters for carpeting



S Casters for hard surfaces



G Nylon glides

Task Seating

Cyrus - Visitor chair with sled base - Medium back

CYRUS

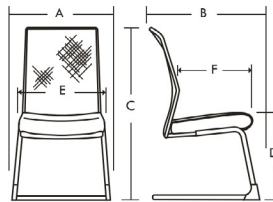
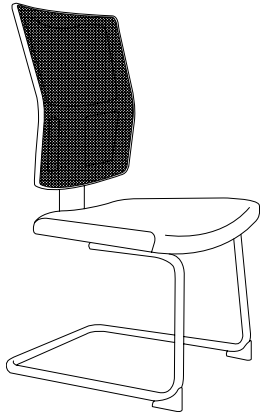

A Chair width	23"
B Chair depth	24"
C Chair height	40,5"
D Seat height	18"
E Backrest width	19,5"
F Seat depth	18,5"

Manufacturing Standards

Cyrus chair

- Medium back in black mesh fabric hugging the curve of the back;
- Seat with polyurethane foam;
- Choice of adjustable or fixed armrests;
- Choice of black nylon or aluminum base with casters;
- Weight of 40 lbs and volume of 10ft³;
- Maximum weight capacity: 250lbs.

Fabric finishes: Selection of fabrics or vinyl by the customer from the supplier of their choice.

COM Fabrics: COM Fabrics are provided by the customer. For pricing please refer GR2 grade price.

Number of yards for COM fabric: [See Appendix B](#)

Code	Total
CYRUS	0,8

Options

Chair options



See [Appendix F](#) for complete options

Prices

Code	GRA	GR1	GR2	GR3	GR4	GR5	GR6	GR7	GR8	GR9	GR10	GR11	GR12	Cuir Leather
CY	856	883	908	933	967	1000	1034	1066	1099	1131	1166	1231	1295	1143

Arms

NA
\$0

AS - AD - FG - FD - F61
\$150

AZ - FZ - F7
\$307

How to Order

Combination of Colors

NA, AS, AD,
F61, FG, FD,
AZ, F7, FZ

Fabrics
[See the fabric chart](#)
Logiflex grade

LC-	CY	-	MWE	-	01	-		-	N				-	MB06
	serie		structure		sled base		arm		leg	supplier	pattern	color		mesh fabric

Example

LC-	CY	-	MWE	-	01	-	NA	-	N	ENNIS	LOFT	AQUA	-	MB06
-----	----	---	-----	---	----	---	----	---	---	-------	------	------	---	------

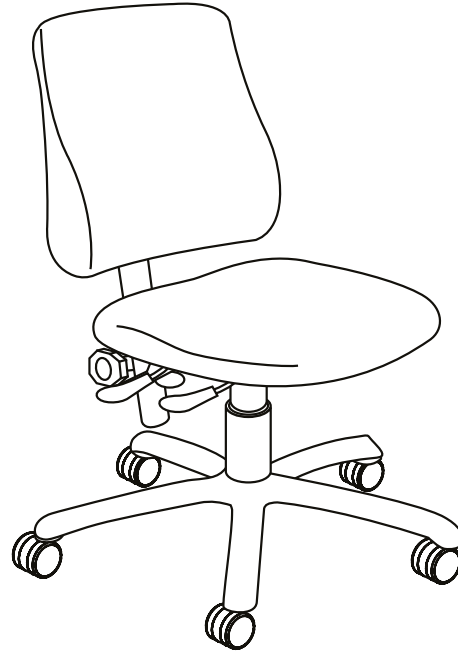

Texto Task Seating

The Texto is Logiflex's most customizable chair, with a variety of different options. Plus, it's ergonomically adjustable with multiple configurations to provide lasting comfort.



Appendix - TEXTO - Options

Chair Width



1 **Narrow seat** (-2")



2 **Standard seat**



3 **Large seat** (+2")
\$174

Chair Back



L **Low back**



M **Medium back**



D **Director back**



H **High back with headrest**

Chair Base



VN **Black nylon tapered base**



ZN **Black nylon rounded base**



VC **Aluminum tapered base**
\$174



ZC **Aluminum rounded base**
\$174



01 **Sled base**



TN **Black nylon rounded stool base**



TC **Aluminum rounded stool base**
\$174

Mechanisms

Mechanism 10 - 11 - 20 - 21

Mechanism 31
\$30

Mechanism 41S - 51
\$60

Mechanism 71
\$126

Mechanism 76F (only with option F)
\$176

Options

S **Seat sliding option**
\$87

R **Back height adjustment option**
\$35

F **Combined options**
\$122



Appendix - TEXTO - Options

Arms



NA
• No arm



AD Adjustable arms
\$150



AS Adjustable arms
\$150



FD Closed fixed arms
\$150



FG Open fixed arms
\$150



FT Open curved fixed arms
\$150



AZ Adjustable arms with multi-axis
and pivot armrests
\$307



FZ Fixed arms
\$307



AG Adjustable arms
\$150



AP Adjustable arms
\$150



AR Adjustable arms
\$150



AW Adjustable arms with pivot
\$150



AX Adjustable arms with multi-axis
armrests
\$232



AY Adjustable arms with multi-axis
and pivot armrests
\$232

Legs



H Casters for carpeting



S Casters for hand surfaces



G Nylon glides



M Mixed (3 casters, 2 glides)

Task Seating

Texto - Chair - Low back

TEXTO

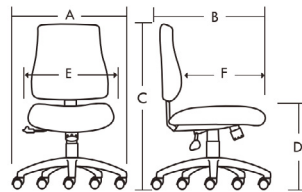
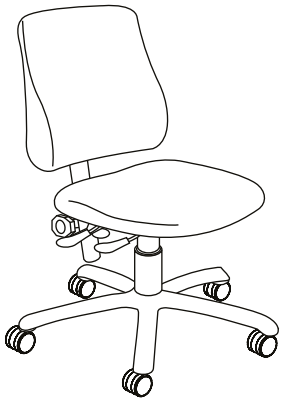

A Chair width	26"
B Chair depth	24"
C Chair height	34" - 39"
D Seat height	17" - 22"
E Backrest width	19"
F Seat depth	18"

Manufacturing Standards

Texto chair:

- Low back following the curve of the back;
- Upholstered seat;
- Choice of black nylon or aluminum base with casters;
- Choice of mechanism;
- Choice of adjustable or fixed arms;
- 40 lbs weight and 10ft³ volume;
- Maximum weight capacity: 250lbs.

Mechanism 76F: Only with option F.

Options: Back height adjustment (R), seat sliding (S), none (-).

Fabric finishes: Selection of fabrics or vinyl by the customer from the supplier of their choice.

COM Fabrics: COM Fabrics are provided by the customer. For pricing please refer GR2 grade price.

Number of yards for COM fabric: [See Appendix B](#)

Code	Total
TEXTO	1,3

Options

Chair options



See [Appendix F](#) for complete options

Prices

Code	GRA	GR1	GR2	GR3	GR4	GR5	GR6	GR7	GR8	GR9	GR10	GR11	GR12	Cuir Leather
TX	860	893	927	960	1001	1040	1084	1126	1167	1207	1248	1330	1414	1460

Width		Back	Base		Mechanism				
1 - 2	3	L	ZN - VN	ZC - VC	10 - 11 - 20 - 21	31	41S - 51	71	76F
\$0	\$174	0\$	\$0	\$174	0\$	\$30	\$60	\$126	\$176
Options			Arms			Legs			
R	S	F	NA	AS - AD - AW - AG - AR - AP - FT - FG - FD		AX - AY	AZ - FZ	H - S - G	
\$35	\$87	\$122	\$0	\$150		\$232	\$307	\$0	

How to Order

LC-	TX	-	L	WW	-	ZN	10, 11	F	NA, AS, AD, AW, AG, AR, AP, FT, FG, FD, AX, AY, AZ, FZ	H	Combination of Colors						
						VC	20, 21	R		S	Fabrics See the fabric chart Logiflex grade						
						VC	31, 41S, 51	S		G	supplier	pattern	color				
Example	LC-	TX	1	-	L	WW	-	ZN	10	R	-	NA	-	H	ENNIS	LOFT	AQUA

Task Seating

Texto - Chair - Medium back

TEXTO

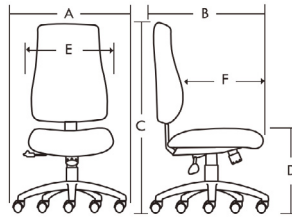
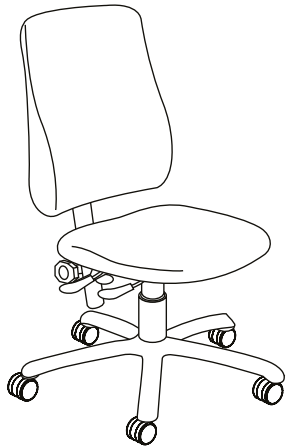

A Chair width	26"
B Chair depth	24"
C Chair height	38" - 43"
D Seat height	17" - 22"
E Backrest width	19"
F Seat depth	18"

Manufacturing Standards

Texto chair:

- Medium back following the curve of the back;
- Upholstered seat;
- Choice of black nylon or aluminum base with casters;
- Choice of mechanism;
- Choice of adjustable or fixed arms;
- 40 lbs weight and 10ft³ volume;
- Maximum weight capacity: 250lbs.

Mechanism 76F: Only with option F.

Options: Back height adjustment (R), seat sliding (S), none (-).

Fabric finishes: Selection of fabrics or vinyl by the customer from the supplier of their choice.

COM Fabrics: COM Fabrics are provided by the customer. For pricing please refer GR2 grade price.

Number of yards for COM fabric:

[See Appendix B](#)

Code	Total
TEXTO	1,5

Options

Chair options



See [Appendix F](#) for complete options

Prices

Code	GRA	GR1	GR2	GR3	GR4	GR5	GR6	GR7	GR8	GR9	GR10	GR11	GR12	Cuir Leather
TX	888	930	969	1007	1054	1102	1153	1201	1250	1299	1348	1446	1543	1538

Width		Back	Base		Mechanism					
1 - 2	3	M	ZN - VN	ZC - VC	10 - 11 - 20 - 21	31	41S - 51	71	76F	
\$0	\$174	0\$	\$0	\$174	0\$	\$30	\$60	\$126	\$176	
Options		Arms							Legs	
R	S	F	NA	AS - AD - AW - AG - AR - AP - FT - FG - FD				AX - AY	AZ - FZ	H - S - G
\$35	\$87	\$122	\$0	\$150				\$232	\$307	\$0

How to Order

LC-	TX	-	M	WW	-												
serie	width		back	structure		base	mechanism	option		arms		legs	supplier	pattern	color		
1	2	3				ZN	10, 11	F		NA, AS, AD, AW, AG, AR, AP, FT, FG, FD, AX, AY, AZ, FZ		H					
						VC	20, 21	R				S					
							31, 41S, 51	S				G					
							71, 76F	-									

Combination of Colors

Fabrics
See the fabric chart
Logiflex grade

Example	LC-	TX	1	-	M	WW	-	ZN	10	R	-	NA	-	H	ENNIS	LOFT	AQUA
----------------	-----	----	---	---	---	----	---	----	----	---	---	----	---	---	-------	------	------

Task Seating

Texto - Chair - Director back

TEXTO

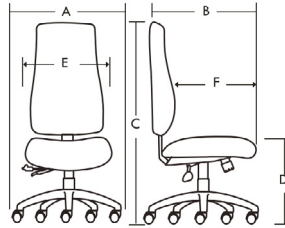
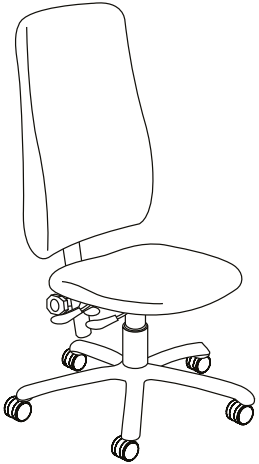

A Chair width	26"
B Chair depth	24"
C Chair height	42" - 47"
D Seat height	17" - 22"
E Backrest width	19"
F Seat depth	18"

Manufacturing Standards

Texto chair:

- Director back following the curve of the back;
- Upholstered seat;
- Choice of black nylon or aluminum base with casters;
- Choice of mechanism;
- Choice of adjustable or fixed arms;
- 45 lbs weight and 13,5ft³ volume;
- Maximum weight capacity: 250lbs.

Mechanism 76F: Only with option F.

Options: Back height adjustment (R), seat sliding (S), none (-).

Fabric finishes: Selection of fabrics or vinyl by the customer from the supplier of their choice.

COM Fabrics: COM Fabrics are provided by the customer. For pricing please refer GR2 grade price.

Number of yards for COM fabric: [See Appendix B](#)

Code	Total
TEXTO	1,7

Options

Chair options



See [Appendix F](#) for complete options

Prices

Code	GRA	GR1	GR2	GR3	GR4	GR5	GR6	GR7	GR8	GR9	GR10	GR11	GR12	Cuir Leather
TX	971	1016	1062	1109	1167	1224	1282	1344	1400	1461	1516	1633	1748	1701

Width		Back	Base		Mechanism				
1 - 2	3	D	ZN - VN	ZC - VC	10 - 11 - 20 - 21	31	41S - 51	71	76F
\$0	\$174	0\$	\$0	\$174	0\$	\$30	\$60	\$126	\$176
Options			Arms			Legs			
R	S	F	NA	AS - AD - AW - AG - AR - AP - FT - FG - FD		AX - AY	AZ - FZ	H - S - G	
\$35	\$87	\$122	\$0	\$150		\$232	\$307	\$0	

How to Order

LC-	TX	-	D	WW	-												
serie	width	back	structure	base	mechanism	option	arms	legs	supplier	pattern	color	Combination of Colors					
1	2	3	ZN	10, 11	F	+	NA, AS, AD, AW, AG, AR, AP, FT, FG, FD, AX, AY, AZ, FZ	H	Fabrics See the fabric chart Logiflex grade								
2			VN	20, 21	R			S									
3			ZC	31, 41S, 51	S			G									
			VC	71, 76F	-												

Example	LC-	TX	1	-	D	WW	-	ZN	10	R	-	NA	-	H	ENNIS	LOFT	AQUA
----------------	-----	----	---	---	---	----	---	----	----	---	---	----	---	---	-------	------	------

Task Seating

Texto - Chair - High back with headrest

TEXTO

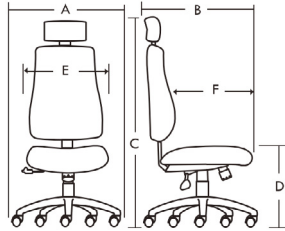
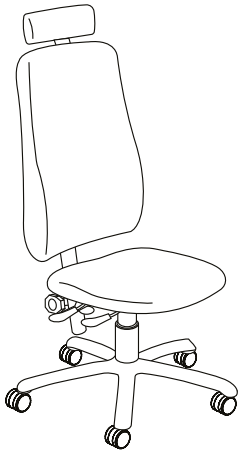

A Chair width	26"
B Chair depth	24"
C Chair height	49" - 54"
D Seat height	17" - 22"
E Backrest width	19"
F Seat depth	18"

Manufacturing Standards

Texto chair:

- High back with headrest following the curve of the back;
- Upholstered seat;
- Choice of black nylon or aluminum base with casters;
- Choice of mechanism;
- Choice of adjustable or fixed arms;
- 50 lbs weight and 13,5ft³ volume;
- Maximum weight capacity: 250lbs.

Mechanism 76F: Only with option F.

Options: Back height adjustment (R), seat sliding (S), none (-).

Fabric finishes: Selection of fabrics or vinyl by the customer from the supplier of their choice.

COM Fabrics: COM Fabrics are provided by the customer. For pricing please refer GR2 grade price.

Number of yards for COM fabric:

[See Appendix B](#)

Code	Total
TEXTO	1,7

Options

Chair options



See [Appendix F](#) for complete options

Prices

Code	GRA	GR1	GR2	GR3	GR4	GR5	GR6	GR7	GR8	GR9	GR10	GR11	GR12	Cuir Leather
TX	1080	1128	1173	1220	1278	1336	1394	1452	1511	1570	1627	1744	1859	1812

Width		Back		Base		Mechanism				
1 - 2 \$0	3 \$174	H 0\$	ZN - VN \$0	ZC - VC \$174	10 - 11 - 20 - 21 0\$	31 \$30	41S - 51 \$60	71 \$126	76F \$176	
Options			Arms			Legs				
R \$35	S \$87	F \$122	NA \$0	AS - AD - AW - AG - AR - AP - FT - FG - FD \$150		AX - AY \$232	AZ - FZ \$307	H - S - G \$0		

How to Order

LC-	TX	-	H	WW	-												
serie	width	back	structure	base	mechanism	option	arms	legs	supplier	pattern	color	Combination of Colors					
												Fabrics					
												See the fabric chart					
												Logiflex grade					
1	2	3	ZN	10, 11	F	+	NA, AS, AD,										
			VN	20, 21	R		AW, AG, AR,										
			ZC	31, 41S, 51	S		AP, FT, FG,	H									
			VC	71, 76F	-		FD, AX, AY,	S									
							AZ, FZ	G									
Example	LC-	TX	1	-	H	WW	-	ZN	10	R	-	NA	-	H	ENNIS	LOFT	AQUA

Task Seating

Texto - Stool - Low back

TEXTO

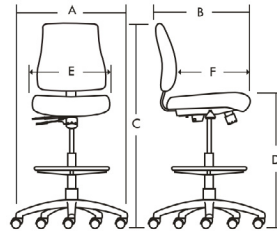
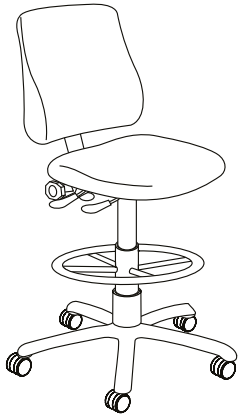

A Chair width	26"
B Chair depth	24"
C Chair height	40" - 50"
D Seat height	23" - 33"
E Backrest width	19"
F Seat depth	18"

Manufacturing Standards

Texto chair (stool):

- Low back following the curve of the back;
- Upholstered seat;
- Choice of black nylon or polished aluminum stool base with casters;
- Choice of mechanism;
- Choice of adjustable or fixed arms;
- 55 lbs weight and 10ft³ volume;
- Maximum weight capacity: 250lbs.

Options: Back height adjustment (R), none (-).

Fabric finishes: Selection of fabrics or vinyl by the customer from the supplier of their choice.

COM Fabrics: COM Fabrics are provided by the customer. For pricing please refer GR2 grade price.

Number of yards for COM fabric:

[See Appendix B](#)

Code	Total
TEXTO	1,3

Options

Chair options



See [Appendix F](#) for complete options

Prices

Code	GRA	GR1	GR2	GR3	GR4	GR5	GR6	GR7	GR8	GR9	GR10	GR11	GR12	Cuir Leather
TX	1053	1085	1119	1152	1193	1233	1275	1316	1358	1398	1440	1521	1604	1649

Width	Back	Base	Mechanism	Options
1 - 2 \$0	L \$0	TN \$0 TC \$174	11 \$0 31 \$30 51 \$60	R \$35
NA \$0	AS - AD - AW - AG - AR - AP - FT - FG - FD \$150		AX - AY \$232 AZ - FZ \$307	H - S - G - M \$0

How to Order

												Combination of Colors					
												Fabrics See the fabric chart Logiflex grade					
LC-	TX	1 2	-	L	WW	-	TN TC	11, 31, 51	R -	NA, AS, AD, AW, AG, AR, AP, FT, FG, FD, AX, AY, AZ, FZ	H S G M	supplier	pattern	color			
serie	width	back	structure	base	mechanism	option	arms	legs	supplier	pattern	color						
Example	LC-	TX	1	-	L	WW	-	TN	11	R	-	NA	-	H	ENNIS	LOFT	AQUA

Task Seating

Texto - Stool - Medium back

TEXTO

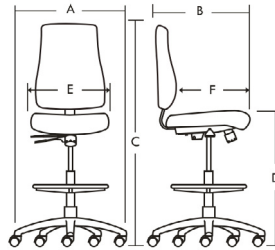
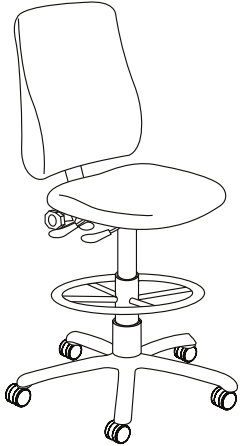

A Chair width	26"
B Chair depth	24"
C Chair height	44" - 54"
D Seat height	23" - 33"
E Backrest width	19"
F Seat depth	18"

Manufacturing Standards

Texto chair (stool):

- Medium back following the curve of the back;
- Upholstered seat;
- Choice of black nylon or polished aluminum stool base with casters;
- Choice of mechanism;
- Choice of adjustable or fixed arms;
- 55 lbs weight and 10ft³ volume;
- Maximum weight capacity: 250lbs.

Options: Back height adjustment (R), none (-).

Fabric finishes: Selection of fabrics or vinyl by the customer from the supplier of their choice.

COM Fabrics: COM Fabrics are provided by the customer. For pricing please refer GR2 grade price.

Number of yards for COM fabric: [See Appendix B](#)

Code	Total
TEXTO	1,5

Options

Chair options



See [Appendix F](#) for complete options

Prices

Code	GRA	GR1	GR2	GR3	GR4	GR5	GR6	GR7	GR8	GR9	GR10	GR11	GR12	Cuir Leather
TX	1079	1121	1159	1198	1246	1296	1345	1394	1442	1488	1540	1638	1735	1728

Width	Back	Base	Mechanism	Options
1 - 2 \$0	M \$0	TN TC \$0 \$174	11 31 51 \$0 \$30 \$60	R \$35
NA \$0	AS - AD - AW - AG - AR - AP - FT - FG - FD \$150		AX - AY AZ - FZ \$232 \$307	H - S - G - M \$0

How to Order

Combination of Colors																	
Fabrics See the fabric chart Logiflex grade																	
LC-	TX	1 2	-	M	WW	-	TN TC	11, 31, 51	R -	NA, AS, AD, AW, AG, AR, AP, FT, FG, FD, AX, AY, AZ, FZ	H S G M						
serie	width	back	structure	base	mechanism	option	arms	legs	supplier	pattern	color						
Example	LC-	TX	1	-	M	WW	-	TN	11	R	-	NA	-	H	ENNIS	LOFT	AQUA

Task Seating

Texto - Visitor chair with sled base - Low back

TEXTO

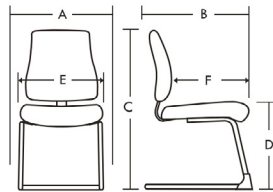
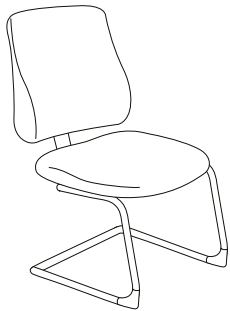

A Chair width	23"
B Chair depth	24"
C Chair height	35"
D Seat height	18"
E Backrest width	19"
F Seat depth	18"

Manufacturing Standards

Texto chair:

- Low back following the curve of the back;
- Upholstered seat;
- Sled base;
- Choice of adjustable or fixed arms;
- 40 lbs weight and 10ft³ volume;
- Maximum weight capacity: 250lbs.

Fabric finishes: Selection of fabrics or vinyl by the customer from the supplier of their choice.

COM Fabrics: COM Fabrics are provided by the customer. For pricing please refer GR2 grade price.

Number of yards for COM fabric: [See Appendix B](#)

Code	Total
TEXTO	1,3

Options

Chair options



See [Appendix F](#) for complete options

Prices

Code	GRA	GR1	GR2	GR3	GR4	GR5	GR6	GR7	GR8	GR9	GR10	GR11	GR12	Cuir Leather
TX2	818	851	885	918	959	999	1039	1084	1125	1165	1205	1289	1371	1558

Back

L
\$0

Arms

NA
\$0

AS - AD - AR - AP - FT - FG - FD
\$150

AZ - FZ
\$307

How to Order

Combination of Colors

NA, AS, AD,
AR, AP, FT,
FG, FD, AZ,
FZ

Fabrics
[See the fabric chart](#)
Logiflex grade

LC-	TX2	-	L	WW	-	01	-	-	-	N			
serie	back	structure	sled base	arms	legs	supplier	pattern	color					

Example LC- TX2 - L WW - 01 - NA - N ENNIS LOFT AQUA

Task Seating

Texto - Visitor chair with sled base - Medium back

TEXTO

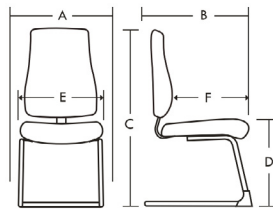
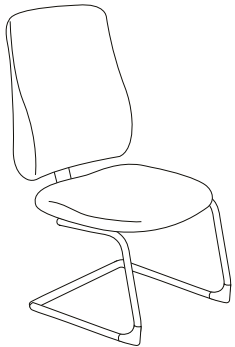

A Chair width	23"
B Chair depth	24"
C Chair height	39"
D Seat height	18"
E Backrest width	19"
F Seat depth	18"

Manufacturing Standards

Texto chair:

- Medium back following the curve of the back;
- Upholstered seat;
- Sled base;
- Choice of adjustable or fixed arms;
- 40 lbs weight and 10ft³ volume;
- Maximum weight capacity: 250lbs.

Fabric finishes: Selection of fabrics or vinyl by the customer from the supplier of their choice.

COM Fabrics: COM Fabrics are provided by the customer. For pricing please refer GR2 grade price.

Number of yards for COM fabric: [See Appendix B](#)

Code	Total
TEXTO	1,5

Options

Chair options



See [Appendix F](#) for complete options

Prices

Code	GRA	GR1	GR2	GR3	GR4	GR5	GR6	GR7	GR8	GR9	GR10	GR11	GR12	Cuir Leather
TX2	848	886	925	964	1012	1062	1111	1159	1207	1256	1305	1403	1502	1636

Back

M
\$0

Arms

NA
\$0

AS - AD - AR - AP - FT - FG - FD
\$150

AZ - FZ
\$307

How to Order

Combination of Colors

NA, AS, AD,
AR, AP, FT,
FG, FD, AZ,
FZ

Fabrics
[See the fabric chart](#)
Logiflex grade

LC-	TX2	-	M	WW	-	01	-	-	-	N			
serie	back	structure	sled base	arms	legs	supplier	pattern	color					

Example LC- TX2 - M WW - 01 - NA - N ENNIS LOFT AQUA

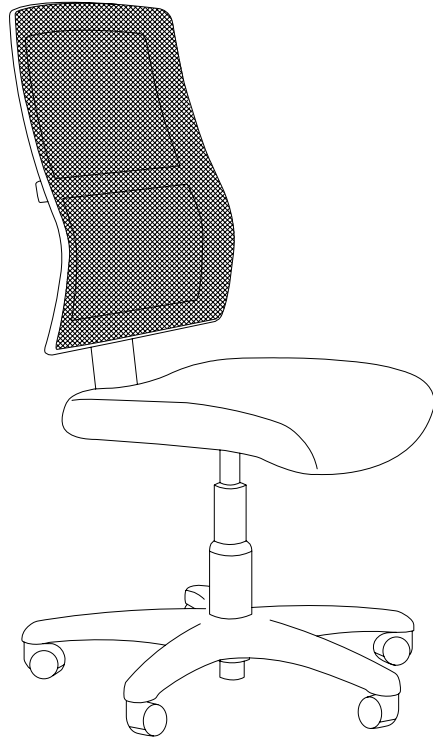

Texto Mesh Task Seating

With fabric mesh backrest and adjustable lumbar support, the Texto Mesh is the perfect office chair.

Task Seating

Appendix - TEXTO MESH - Options

Chair width



2 Standard seat



3 Large seat (+2")
\$174

Chair base



VN Black nylon tapered base



ZN Black nylon rounded base



VC Aluminum tapered base
\$174



ZC Aluminum rounded base
\$174



01 Sled base



TN Black nylon rounded stool base



TC Aluminum rounded stool base
\$174

Mechanisms

Mecanism 10 - 11 - 20 - 21

Mecanism 31
\$30

Mecanism 41S - 51
\$60

Mecanism 71
\$126

Options

S Seat sliding option
\$87

R Back height Adjustment option
\$35

F Combined options
\$122

Task Seating

Appendix - TEXTO MESH - Options

Arms



NA
• No arm

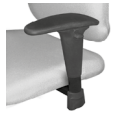

AD Adjustable arms
\$150



AS Adjustable arms
\$150



FD Closed fixed arms
\$150



FG Open fixed arms
\$150



FT Bras fixes courbés ouverts
\$150



AZ Adjustable arms with multi-axis
and pivot armrests
\$307



FZ Fixed arms
\$307



AG Adjustable arms
\$150



AP Adjustable arms
\$150



AR Adjustable arms
\$150



AW Adjustable arms with pivot
\$150



AX Adjustable arms with multi-axis
armrests
\$232



AY Adjustable arms with multi-axis
and pivot armrests
\$232

Legs



H Casters for carpeting



S Casters for hard surfaces



G Nylon glides



M Mixed (3 casters, 2 glides)

Mesh Fabrics



MA06 Aero Mesh Black
Pantone Black 6 C (#101820)

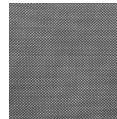

MA16 Graphite
Pantone Cool Gray 9 C (#75787B)



MA26 Aluminum
Pantone #7537 C



MA60 Sangria
Pantone #2041 C

Task Seating

Texto Mesh - Chair - Medium Back

TXM

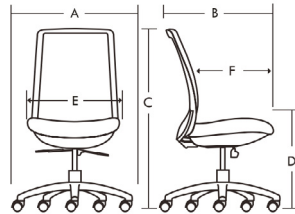
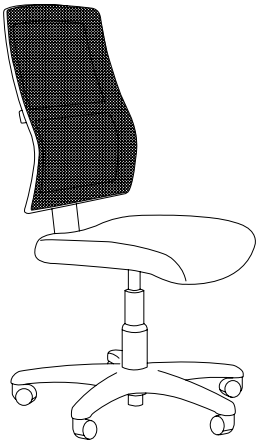

A Chair width	26"
B Chair depth	24"
C Chair height	39" - 44"
D Seat height	17" - 22"
E Backrest width	19"
F Seat depth	18"

Manufacturing Standards

Texto Mesh chair:

- Medium back following the curve of the back;
- Upholstered seat;
- Choice of black nylon or aluminum base with casters;
- Choice of mechanism;
- Choice of adjustable or fixed arms;
- 40 lbs weight and 10ft³ volume;
- Maximum weight capacity: 250lbs.

Options: Back height adjustment (R), seat sliding (S), none (-).

Fabric finishes: Selection of fabrics or vinyl by the customer from the supplier of their choice.

COM Fabrics: COM Fabrics are provided by the customer. For pricing please refer GR2 grade price.

Number of yards for COM fabric: [See Appendix B](#)

Code	Total
TEXTO	0,9

Options

Chair options



See [Appendix F](#) for complete options

Prices

Code	GRA	GR1	GR2	GR3	GR4	GR5	GR6	GR7	GR8	GR9	GR10	GR11	GR12	Cuir Leather
TXM	886	911	937	963	995	1026	1057	1089	1123	1154	1185	1249	1314	1165

Width

2	3
\$0	\$174

Base

ZN - VN	ZC - VC
\$0	\$174

Mechanism

10 - 11 - 20 - 21	31	41S - 51	71
\$0	\$30	\$60	\$126

Options

R	S	F
\$35	\$87	\$122

Arms

NA	AS - AD - AW - AG - AR - AP - FT - FG - FD	AX - AY	AZ - FZ
\$0	\$150	\$232	\$307

Legs

H - S - G
\$0

How to Order

LC-	TXM	-	MWE	-	ZN	10, 11	F	NA, AS, AD, AW, AG, AR, AP, FT, FG, FD, AX, AY, AZ, FZ	H	Combination of Colors	MA06
serie	width	high + structure	base	mechanism	option	arms	legs	supplier	pattern	color	Mesh fabric
2	3										

Example

LC-	TXM	2	-	MWE	-	ZN	10	R	-	NA	-	H	ENNIS	LOFT	AQUA	-	MA06
-----	-----	---	---	-----	---	----	----	---	---	----	---	---	-------	------	------	---	------

Task Seating

Texto Mesh - Stool - Medium back

TXM2

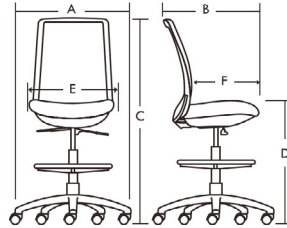
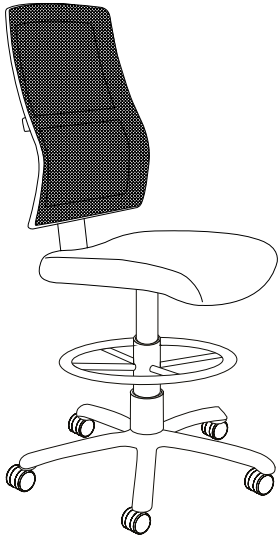

A Chair width	26"
B Chair depth	24"
C Chair height	45" - 55"
D Seat height	23" - 33"
E Backrest width	19"
F Seat depth	18"

Manufacturing Standards

Texto Mesh chair (stool):

- Medium back following the curve of the back;
- Upholstered seat;
- Choice of black nylon or polished aluminum stool base with casters;
- Choice of mechanism;
- Choice of adjustable or fixed arms;
- 55 lbs weight and 10ft³ volume;
- Maximum weight capacity: 250lbs.

Options: Back height adjustment (R), none (-).

Fabric finishes: Selection of fabrics or vinyl by the customer from the supplier of their choice.

COM Fabrics: COM Fabrics are provided by the customer. For pricing please refer GR2 grade price.

Number of yards for COM fabric:

[See Appendix B](#)

Code	Total
TEXTO	0,9

Options

Chair options



See [Appendix F](#) for complete options

Prices

Code	GRA	GR1	GR2	GR3	GR4	GR5	GR6	GR7	GR8	GR9	GR10	GR11	GR12	Cuir Leather
TXM2	1077	1102	1128	1154	1185	1218	1249	1280	1314	1344	1377	1440	1505	1357

Base

TN	TC
\$0	\$174

Mechanism

11	31	51
\$0	\$30	\$60

Options

R
\$35

Arms

NA	AS - AD - AW - AG - AR - AP - FT - FG - FD
\$0	\$150

AX - AY
\$232

AZ - FZ
\$307

Legs

H - S - G - M
\$0

How to Order

										Combination of Colors							
										Fabrics See the fabric chart Logiflex grade							
LC-	TXM2	-	MWE	-	TN	11, 31, 51	R	NA, AS, AD, AW, AG, AR, AP, FT, FG, FD, AX, AY, AZ, FZ	H S G M	ENNIS	LOFT	AQUA	-	MA06 MA16 MA26 MA60			
serie	high + structure	base	mechanism	option	arms	legs	supplier	pattern	color	Mesh fabric							
Example	LC-	TXM2	-	MWE	-	TN	11	R	-	NA	-	H	ENNIS	LOFT	AQUA	-	MA06

Task Seating

Texto Mesh - Visitor chair with sled base - Medium back

TXM2

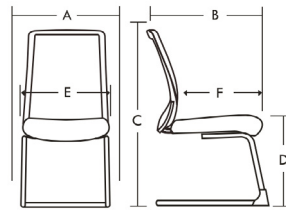
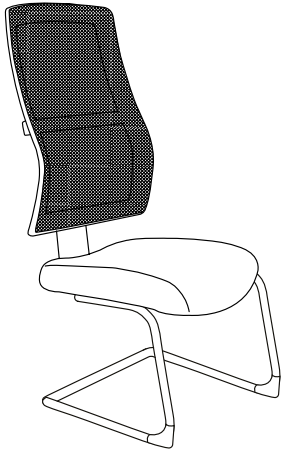

A Chair width	23"
B Chair depth	24"
C Chair height	40"
D Seat height	18"
E Backrest width	19"
F Seat depth	18"

Manufacturing Standards

Texto Mesh chair:

- Medium back following the curve of the back;
- Upholstered seat;
- Sled base;
- Choice of adjustable or fixed arms;
- 40 lbs weight and 10ft³ volume;
- Maximum weight capacity: 250lbs.

Fabric finishes: Selection of fabrics or vinyl by the customer from the supplier of their choice.

COM Fabrics: COM Fabrics are provided by the customer. For pricing please refer GR2 grade price.

Number of yards for COM fabric: [See Appendix B](#)

Code	Total
TEXTO	0,9

Options

Chair options



See [Appendix F](#) for complete options

Prices

Code	GRA	GR1	GR2	GR3	GR4	GR5	GR6	GR7	GR8	GR9	GR10	GR11	GR12	Cuir Leather
TXM2	843	868	895	920	952	983	1016	1049	1079	1110	1144	1205	1271	1123

Arms

NA	AS - AD - AR - AP - FT - FG - FD	AZ - FZ
\$0	\$150	\$307

How to Order

Combination of Colors

NA, AS, AD,
AR, AP, FT,
FG, FD, AZ,
FZ

Fabrics
[See the fabric chart](#)
Logiflex grade

MA06
MA16
MA26
MA60

LC-	TXM2	-	MWE	-	01	-	N							
	serie		high + structure		sled base		arms	legs	supplier	pattern	color		Mesh fabric	

Example	LC-	TXM2	-	MWE	-	01	-	NA	-	N	ENNIS	LOFT	AQUA	-	MA06
----------------	-----	------	---	-----	---	----	---	----	---	---	-------	------	------	---	------

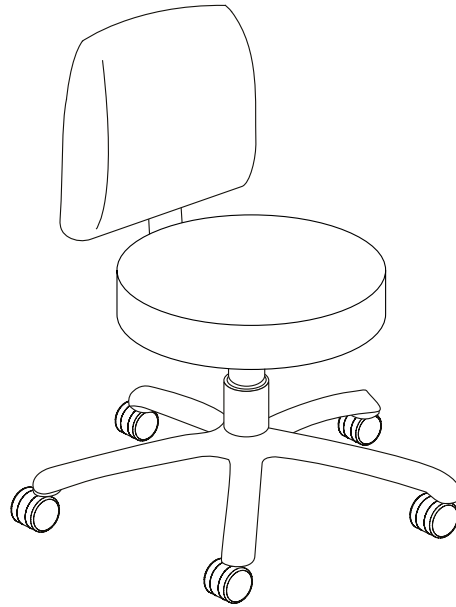

Texto Lab Laboratory Seating

A round seat and different backrest options make the Texto Lab a versatile chair that doesn't take up much space. It can easily be tucked under a counter, and a stool version is available with a footrest.

Task Seating

Appendix - TEXTO LAB - Options

Chair back



X No back



T T-shaped back

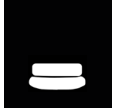

C Contour back



L Low back

Chair base



ZN Black nylon rounded base



ZC Aluminum rounded base
\$174



TN Black nylon rounded stool base



TC Aluminum rounded stool base
\$174

Mechanisms

Mecanism 11

Mecanism 31
\$30

Mecanism 51
\$60

Option

R Back height Adjustment option
\$35

Legs



H Casters for carpeting



S Casters for hand surfaces



G Nylon glides



M Mixed (3 casters, 2 glides)

Task Seating

Texto Lab - Chair - No back

TXR

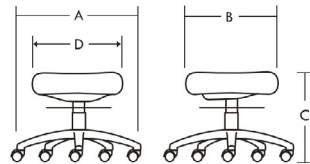
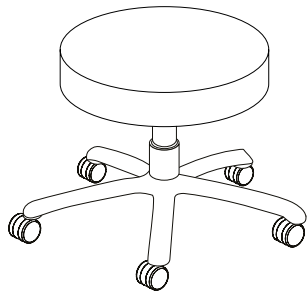

A Chair width	26"
B Chair depth	17,5"
C Chair high (cyl.24)	15,5" - 20,5"
C Chair high (cyl.30)	17" - 24,5"

Manufacturing Standards

Texto Lab chair:

- No back;
- Upholstered seat;
- Choice of black nylon or aluminum base with casters;
- Choice of cylinder;
- 20 lbs weight and 6ft³ volume;
- Maximum weight capacity: 250lbs.

Fabric finishes: Selection of fabrics or vinyl by the customer from the supplier of their choice.

COM Fabrics: COM Fabrics are provided by the customer. For pricing please refer GR2 grade price.

Number of yards for COM fabric: [See Appendix B](#)

Code	Total
TEXTO	0,7

Options

Chair options

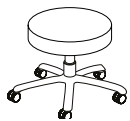

See [Appendix F](#) for complete options

Prices

Code	GRA	GR1	GR2	GR3	GR4	GR5	GR6	GR7	GR8	GR9	GR10	GR11	GR12	Cuir Leather
TXR	520	541	559	580	604	629	654	677	701	727	750	800	849	851

Back

X

\$0

Base

ZN

\$0

ZC

\$174

Cylinder

24 - 30

\$0

Legs

H - S - G - M

\$0

How to Order

Combination of Colors

Fabrics

See the fabric chart
Logiflex grade

LC-	TXR	-	X	WW	-	ZN	18	13	-	NA	-	H			
	serie		back	structure		base	cylinder	mechanism		arms		legs	supplier	pattern	color

Example	LC-	TXR	-	X	WW	-	ZN	18	13	-	NA	-	H	ENNIS	LOFT	AQUA
----------------	-----	-----	---	---	----	---	----	----	----	---	----	---	---	-------	------	------

Task Seating

Texto Lab - Chair - T-shaped back

TXR

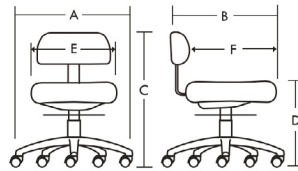
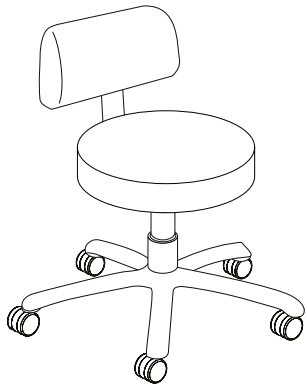

A Chair width	26"
B Chair depth	21"
C Chair high (cyl.24)	25,5" - 30,5"
C Chair high (cyl.30)	27" - 34,5"
D Seat height (cyl.24)	15,5" - 20,5"
D Seat height (cyl.30)	17" - 24,5"
E Back width	17,5"
F Seat depth	17,5"

Manufacturing Standards

- Texto Lab chair:
- T-shaped back;
 - Upholstered seat;
 - Choice of black nylon or aluminum base with casters;
 - Choice of cylinder;
 - 20 lbs weight and 6ft³ volume;
 - Maximum weight capacity: 250lbs.

Fabric finishes: Selection of fabrics or vinyl by the customer from the supplier of their choice.

COM Fabrics: COM Fabrics are provided by the customer. For pricing please refer GR2 grade price.

Number of yards for COM fabric: [See Appendix B](#)

Code	Total
TEXTO	0,7

Options

Chair options



See [Appendix F](#) for complete options

Prices

Code	GRA	GR1	GR2	GR3	GR4	GR5	GR6	GR7	GR8	GR9	GR10	GR11	GR12	Cuir Leather
TXR	620	639	659	678	702	728	751	777	801	825	850	898	948	950

Back	Base	Cylinder	Legs
T \$0	ZN \$0 ZC \$174	24 - 30 \$0	H - S - G - M \$0

How to Order

Combination of Colors

Fabrics
See the fabric chart
Logiflex grade

LC-	TXR	-	T	WW	-	ZN	18	13	-	NA	-	H	ENNIS	LOFT	AQUA
	serie		back	structure		base	cylinder	mechanism		arms		legs	supplier	pattern	color

Example LC- TXR - T WW - ZN 18 13 - NA - H ENNIS LOFT AQUA

Task Seating

Texto Lab - Chair - Contour back

TXR

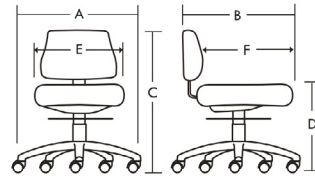
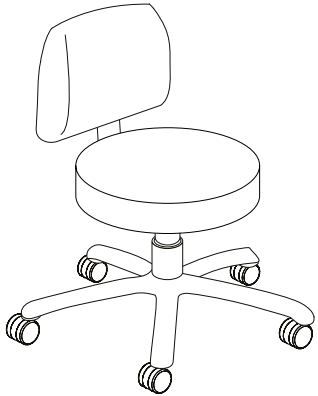

A Chair width	26"
B Chair depth	21"
C Chair high (cyl.24)	26,5" - 31,5"
C Chair high (cyl.30)	28" - 35,5"
D Seat height (cyl.24)	16,5" - 21,5"
D Seat height (cyl.30)	18" - 25,5"
E Back width	17,5"
F Seat depth	17,5"

Manufacturing Standards

Texto Lab chair:

- Contour back;
- Upholstered seat;
- Choice of black nylon or aluminum base with casters;
- Choice of cylinder;
- Choice of mechanism;
- 30 lbs weight and 10ft³ volume;
- Maximum weight capacity: 250lbs.

Options: Back height adjustment (R), none (-).

Fabric finishes: Selection of fabrics or vinyl by the customer from the supplier of their choice.

COM Fabrics: COM Fabrics are provided by the customer. For pricing please refer GR2 grade price.

Number of yards for COM fabric:

[See Appendix B](#)

Code	Total
TEXTO	0,95

Options

Chair options



See [Appendix F](#) for complete options

Prices

Code	GRA	GR1	GR2	GR3	GR4	GR5	GR6	GR7	GR8	GR9	GR10	GR11	GR12	Cuir Leather
TXR	726	751	779	805	840	873	906	941	975	1008	1043	1110	1178	1191

Back	Base	Cylinder	Mechanism	Option	Legs
C	ZN ZC	18-24	11 31 51	R	H-S-G-M
\$0	\$0 \$174	\$0	\$0 \$30 \$60	\$35	\$0

How to Order

													Combination of Colors				
LC-	TXR	-	C	WW	-	ZN ZC	18 24	11, 31, 51	R -	-	NA	-	H S G M	Fabrics <i>See the fabric chart Logiflex grade</i>			
serie	back	structure	base	cylinder	mechanism	option	arms	legs	supplier	pattern	color						
Exemple	LC-	TXR	-	C	WW	-	ZN	18	11	R	-	NA	-	H	ENNIS	LOFT	AQUA

Task Seating

Texto Lab - Chair - Low back

TXR

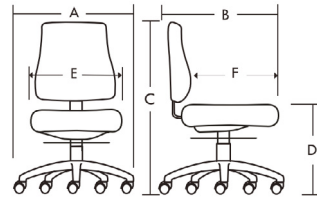
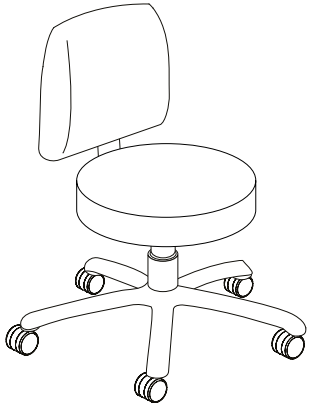

A Chair width	26"
B Chair depth	24"
C Chair high (cyl.24)	33,5" - 38,5"
C Chair high (cyl.30)	35" - 42,5"
D Seat height (cyl.24)	16,5" - 21,5"
D Seat height (cyl.30)	18" - 25,5"
E Back width	17,5"
F Seat depth	17,5"

Manufacturing Standards

Texto Lab chair:

- Low back following the curve of the back;
- Upholstered seat;
- Choice of black nylon or aluminum base with casters;
- Choice of cylinder;
- Choice of mechanism;
- 40 lbs weight and 10ft³ volume;
- Maximum weight capacity: 250lbs.

Options: Back height adjustment (R), none (-).

Fabric finishes: Selection of fabrics or vinyl by the customer from the supplier of their choice.

COM Fabrics: COM Fabrics are provided by the customer. For pricing please refer GR2 grade price.

Number of yards for COM fabric:

[See Appendix B](#)

Code	Total
TEXTO	1,3

Options

Chair options



See [Appendix F](#) for complete options

Prices

Code	GRA	GR1	GR2	GR3	GR4	GR5	GR6	GR7	GR8	GR9	GR10	GR11	GR12	Cuir Leather
TXR	825	863	901	937	985	1032	1079	1126	1173	1220	1267	1362	1453	1497

Back

L

\$0

Base

ZN

\$0

ZC

\$174

Cylinder

18 - 24

\$0

Mechanism

11

\$0

31

\$30

51

\$60

Option

R

\$35

Legs

H - S - G - M

\$0

How to Order

													Combination of Colors				
													Fabrics See the fabric chart Logiflex grade				
LC-	TXR	-	L	WW	-	ZN ZC	18 24	11, 31, 51	R -	-	NA	-	H S G M				
serie	back	structure	base	cylinder	mechanism	option	arms	legs	supplier	pattern	color						
Example	LC-	TXR	-	L	WW	-	ZN	18	11	R	-	NA	-	H	ENNIS	LOFT	AQUA

Task Seating

Texto Lab - Stool - No back

TXR

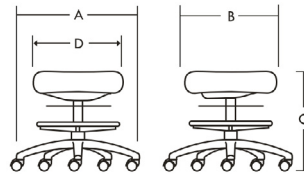
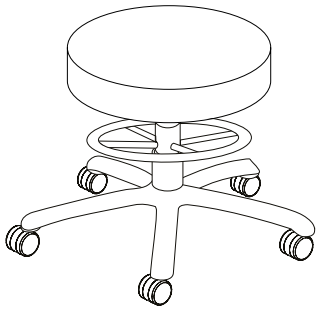

A Chair width	26"
B Chair depth	17,5"
C Chair high (cyl.24)	17" - 24,5"
C Chair high (cyl.30)	22" - 32"
D Back width	17,5"

Manufacturing Standards

Texto Lab chair (stool):

- No back;
- Upholstered seat;
- Choice of black nylon or polished aluminum stool base with casters;
- Choice of cylinder;
- 30 lbs weight and 6ft³ volume;
- Maximum weight capacity: 250lbs.

Fabric finishes: Selection of fabrics or vinyl by the customer from the supplier of their choice.

COM Fabrics: COM Fabrics are provided by the customer. For pricing please refer GR2 grade price.

Number of yards for COM fabric: [See Appendix B](#)

Code	Total
TEXTO	0,7

Options

Chair options

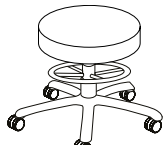

See [Appendix F](#) for complete options

Prices

Code	GRA	GR1	GR2	GR3	GR4	GR5	GR6	GR7	GR8	GR9	GR10	GR11	GR12	Cuir Leather
TXR	712	732	750	770	794	819	845	868	892	918	941	988	1039	1043

Back

X

\$0

Base

TN

\$0

TC

\$174

Cylinder

24 - 30

\$0

Legs

H - S - G - M

\$0

How to Order

Combination of Colors

Fabrics

See the [fabric chart](#)
Logiflex grade

LC-	TXR	-	X	WW	-	TN	24	13	-	NA	-	H	ENNIS	LOFT	AQUA
	serie		back	structure		base	cylinder	mechanism		arms		legs	supplier	pattern	color

Example

LC-	TXR	-	X	WW	-	TN	24	13	-	NA	-	H	ENNIS	LOFT	AQUA
-----	-----	---	---	----	---	----	----	----	---	----	---	---	-------	------	------

Task Seating

Texto Lab - Stool - T-shaped back

TXR

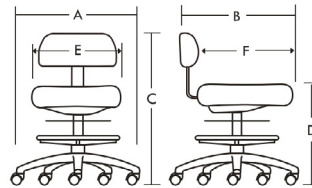
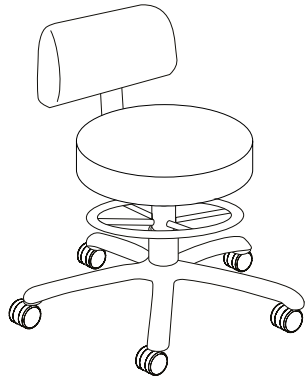

A Chair width	26"
B Chair depth	21"
C Chair high (cyl.24)	27" - 34,5"
C Chair high (cyl.30)	32" - 42"
D Seat height (cyl.24)	17" - 24,5"
D Seat height (cyl.30)	22" - 32"
E Back width	17,5"
F Seat depth	17,5"

Manufacturing Standards

- Texto Lab chair (stool):
- T-shaped back;
 - Upholstered seat;
 - Choice of black nylon or polished aluminum stool base with casters;
 - Choice of cylinder;
 - 40 lbs weight and 10ft³ volume;
 - Maximum weight capacity: 250lbs.

Fabric finishes: Selection of fabrics or vinyl by the customer from the supplier of their choice.

COM Fabrics: COM Fabrics are provided by the customer. For pricing please refer GR2 grade price.

Number of yards for COM fabric: [See Appendix B](#)

Code	Total
TEXTO	0,8

Options

Chair options

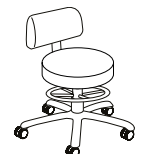

See [Appendix F](#) for complete options

Prices

Code	GRA	GR1	GR2	GR3	GR4	GR5	GR6	GR7	GR8	GR9	GR10	GR11	GR12	Cuir Leather
TXR	812	830	850	870	893	920	943	969	990	1018	1040	1088	1136	1140

Back	Base	Cylinder	Legs
T	TN TC	24 - 30	H - S - G - M
\$0	\$0 \$174	\$0	\$0

How to Order

Combination of Colors

Fabrics
See the fabric chart
Logiflex grade

LC-	TXR	-	T	WW	-	TN	24	13	-	NA	-	H	ENNIS	LOFT	AQUA
serie	back	structure	base	cylinder	mechanism	arms	legs	supplier	pattern	color					

Example LC- TXR - T WW - TN 24 13 - NA - H ENNIS LOFT AQUA

Task Seating

Texto Lab - Stool - Contour back

TXR

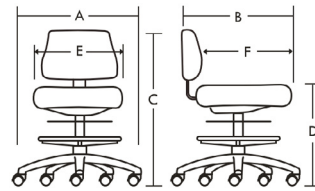
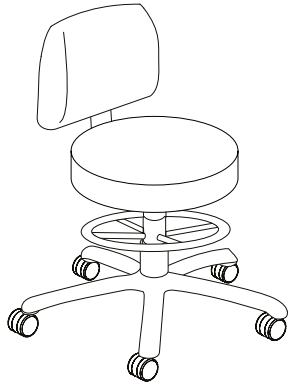

A Chair width	26"
B Chair depth	21"
C Chair high (cyl.24)	27" - 34,5"
C Chair high (cyl.30)	32" - 42"
D Seat height (cyl.24)	17" - 24,5"
D Seat height (cyl.30)	22" - 32"
E Back width	17,5"
F Seat depth	17,5"

Manufacturing Standards

Texto Lab chair (stool):

- Contour back;
- Upholstered seat;
- Choice of black nylon or polished aluminum stool base with casters;
- Choice of cylinder;
- Choice of mechanism;
- 30 lbs weight and 10ft³ volume;
- Maximum weight capacity: 250lbs.

Options: Back height adjustment (R), none (-).

Fabric finishes: Selection of fabrics or vinyl by the customer from the supplier of their choice.

COM Fabrics: COM Fabrics are provided by the customer. For pricing please refer GR2 grade price.

Number of yards for COM fabric:

[See Appendix B](#)

Code	Total
TEXTO	0,95

Options

Chair options



See [Appendix F](#) for complete options

Prices

Code	GRA	GR1	GR2	GR3	GR4	GR5	GR6	GR7	GR8	GR9	GR10	GR11	GR12	Cuir Leather
TXR	917	943	971	997	1030	1063	1099	1132	1166	1200	1233	1301	1369	1382

Back	Base	Cylinder	Mechanism	Options	Legs
C	TN TC	24 - 30	11 31 51	R	H - S - G - M
\$0	\$0 \$174	\$0	\$0 \$30 \$60	\$35	\$0

How to Order

													Combination of Colors				
													Fabrics <i>See the fabric chart Logiflex grade</i>				
LC-	TXR	-	C	WW	-	TN TC	24 30	11, 31, 51	R -	-	NA	-	H S G M				
serie			back	structure		base	cylinder	mechanism	option		arms		legs	supplier	pattern	color	
Example	LC-	TXR	-	C	WW	-	TN	24	11	R	-	NA	-	H	ENNIS	LOFT	AQUA

Task Seating

Texto Lab - Stool - Low back

TXR

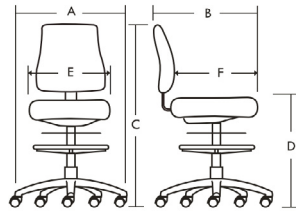
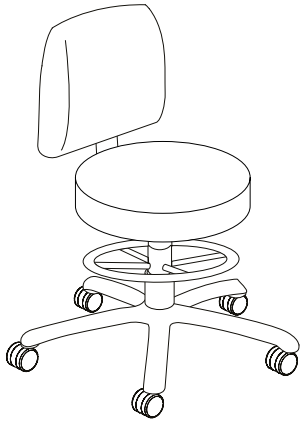

A Chair width	26"
B Chair depth	21"
C Chair high (cyl.24)	27" - 34,5"
C Chair high (cyl.30)	32" - 42"
D Seat height (cyl.24)	17" - 24,5"
D Seat height (cyl.30)	22" - 32"
E Back width	17,5"
F Seat depth	17,5"

Manufacturing Standards

Texto Lab chair (stool):

- Low back following the curve of the back;
- Upholstered seat;
- Choice of black nylon or polished aluminum stool base with casters;
- Choice of cylinder;
- Choice of mechanism;
- 30 lbs weight and 10ft³ volume;
- Maximum weight capacity: 250lbs.

Options: Back height adjustment (R), none (-).

Fabric finishes: Selection of fabrics or vinyl by the customer from the supplier of their choice.

COM Fabrics: COM Fabrics are provided by the customer. For pricing please refer GR2 grade price.

Number of yards for COM fabric:

[See Appendix B](#)

Code	Total
TEXTO	0,95

Options

Chair options

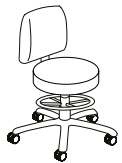

See [Appendix F](#) for complete options

Prices

Code	GRA	GR1	GR2	GR3	GR4	GR5	GR6	GR7	GR8	GR9	GR10	GR11	GR12	Cuir Leather
TXR	1018	1054	1091	1129	1176	1224	1270	1316	1364	1411	1456	1551	1645	1689

Back

L

\$0

Base

TN TC

\$0

\$174

Cylinder

24 - 30

\$0

Mechanism

11

\$0

31

\$30

51

\$60

Options

R

\$35

Legs

H - S - G - M

\$0

How to Order

													Combination of Colors				
													Fabrics See the fabric chart Logiflex grade				
LC-	TXR	-	L	WW	-	TN TC	24 30	11, 31, 51	R -	-	NA	-	H S G M				
serie	back	structure	base	cylinder	mechanism	option	arms	legs	supplier	pattern	color						
Example	LC-	TXR	-	L	WW	-	TN	24	11	R	-	NA	-	H	ENNIS	LOFT	AQUA

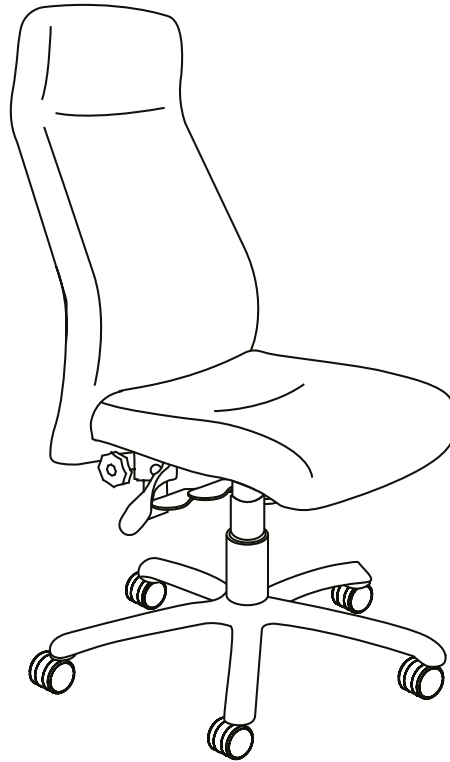

Elie Task Seating

The elegant and prestigious Elie Chair is the perfect choice for executives. The sled base option means that it can also be used for guests, and it fits perfectly with any decor.

Task Seating



Appendix - ELIE - Options

Chair backs



M Medium back



H High back

Chair bases



VN Black nylon tapered base



ZN Black nylon rounded base



VC Aluminum tapered base
\$174



ZC Aluminum rounded base
\$174



01 Sled base

Mechanism

Mechanism 10 - 11 - 20 - 21

Mechanism 31
\$30

Mechanism 41S - 51
\$60

Options

S Seat sliding option
\$87

Arms



NA
• No arms



AD Adjustable arms
\$150



AS Adjustable arms
\$150



FD Closed fixed arms
\$150



FG Open fixed arms
\$150



FT Open curved fixed arms
\$150



AZ Adjustable arms with multi-axis
and pivot armrests
\$307



FZ Fixed arms
\$307

Legs



H Casters for carpeting



S Casters for hard surfaces



G Nylon glides

Task Seating

Elie - Chair - Medium back

ELIE

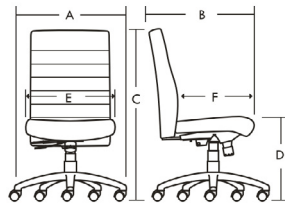

A Chair width	26"
B Chair depth	24,5"
C Chair height	38,5" - 43,5"
D Seat height	17,5" - 22,5"
E Backrest width	19"
F Seat depth	19"

Manufacturing Standards

Elie chair:

- Medium back following the curve of the back;
- Upholstered seat;
- Choice of black nylon or aluminum base with casters;
- Choice of mechanism;
- Choice of adjustable or fixed arms;
- 45 lbs weight and 13,5ft³ volume;
- Maximum weight capacity: 250lbs.

Options: Seat sliding (S), none (-).

Fabric finishes: Selection of fabrics or vinyl by the customer from the supplier of their choice.

COM Fabrics: COM Fabrics are provided by the customer. For pricing please refer GR2 grade price.

Number of yards for COM fabric:

[See Appendix B](#)

Code	Total
ELIE	2.1

Options

Chair options



See [Appendix F](#) for complete options

Prices

Code	GRA	GR1	GR2	GR3	GR4	GR5	GR6	GR7	GR8	GR9	GR10	GR11	GR12	Cuir Leather
EE	1160	1194	1241	1288	1345	1403	1461	1518	1576	1634	1692	1808	1922	1878

Back

M
\$0

Bases

ZN - VN \$0
ZC - VC \$174

Mechanisms

10 - 11 - 20 - 21 \$0
31 \$30
41S - 51 \$60

Options

S \$87

Arms

NA \$0
AS - AD - FT - FG - FD \$150

AZ - FZ \$307

Legs

H - S - G \$0

How to Order

													Combination of Colors			
LC-	EE	-	M	WW	-	ZN VN VC	10, 11, 20, 21, 31, 41S, 51	S -	NA, AS, AD, FT, FG, FD, AZ, FZ	H S G	Fabrics See the fabric chart Logiflex grade					
serie	back	structure	base	Mechanism	option	arm	leg	supplier	pattern	color						
Example	LC-	EE	-	M	WW	-	ZN	11	S	-	NA	-	H	ENNIS	LOFT	AQUA

Task Seating

Elie - Chair - High back

ELIE

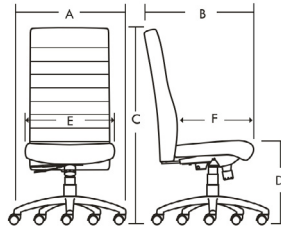
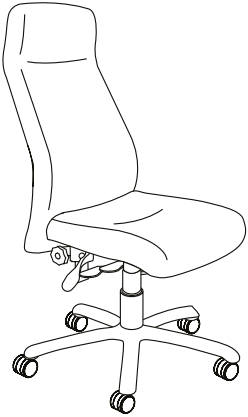

A Chair width	26"
B Chair depth	25"
C Chair height	47,5" - 52,5"
D Seat height	17,5" - 22,5"
E Backrest width	19"
F Seat depth	19"

Manufacturing Standards

Elie chair:

- High back following the curve of the back;
- Upholstered seat;
- Choice of black nylon or aluminum base with casters;
- Choice of mechanism;
- Choice of adjustable or fixed arms;
- 45 lbs weight and 13,5ft³ volume;
- Maximum weight capacity: 250lbs.

Options: Seat sliding (S), none (-).

Fabric finishes: Selection of fabrics or vinyl by the customer from the supplier of their choice.

COM Fabrics: COM Fabrics are provided by the customer. For pricing please refer GR2 grade price.

Number of yards for COM fabric: [See Appendix B](#)

Code	Total
ELIE	2,3

Options

Chair options



See [Appendix F](#) for complete options

Prices

Code	GRA	GR1	GR2	GR3	GR4	GR5	GR6	GR7	GR8	GR9	GR10	GR11	GR12	Cuir Leather
EE	1372	1412	1466	1519	1585	1651	1718	1785	1851	1917	1983	2116	2250	2286

Back

H
\$0

Bases

ZN - VN \$0
ZC - VC \$174

Mechanisms

10 - 11 - 20 - 21 \$0
31 \$30
41S - 51 \$60

Options

S
\$87

Arms

NA \$0
AS - AD - FT - FG - FD \$150

AZ - FZ \$307

Legs

H - S - G \$0

How to Order

											Combination of Colors					
LC-	EE	-	H	WW	-	ZN VN VC	10, 11, 20, 21, 31, 41S, 51	S -	NA, AS, AD, FT, FG, FD, AZ, FZ	H S G	Fabrics <i>See the fabric chart Logiflex grade</i>					
serie	back	structure	base	Mechanism	option	arm	leg	supplier	pattern	color						
Example	LC-	EE	-	H	WW	-	ZN	11	S	-	NA	-	H	ENNIS	LOFT	AQUA

Task Seating

Elie - Visitor chair with sled base - Medium back

ELIE

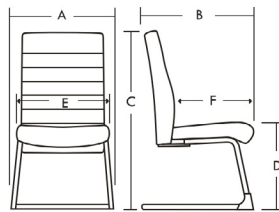

A Chair width	24"
B Chair depth	24,5"
C Chair height	39"
D Seat height	18"
E Backrest width	19"
F Seat depth	19"

Manufacturing Standards

- Elie chair:
- Medium back following the curve of the back;
 - Upholstered seat;
 - Sled base;
 - Choice of adjustable or fixed arms;
 - 45 lbs weight and 13,5ft³ volume;
 - Maximum weight capacity: 250lbs.

Fabric finishes: Selection of fabrics or vinyl by the customer from the supplier of their choice.

COM Fabrics: COM Fabrics are provided by the customer. For pricing please refer GR2 grade price.

Number of yards for COM fabric: [See Appendix B](#)

Code	Total
ELIE	2,1

Options

Chair options



See [Appendix F](#) for complete options

Prices

Code	GRA	GR1	GR2	GR3	GR4	GR5	GR6	GR7	GR8	GR9	GR10	GR11	GR12	Cuir Leather
EE	1120	1154	1200	1246	1304	1362	1418	1477	1534	1593	1651	1766	1881	1836

Arms

NA	AS - AD - FT - FG - FD	AZ - FZ
\$0	\$150	\$307

How to Order

Combination of Colors

LC-	EE	-	MWW	-	01	-	NA	-	N				
serie	height + structure	sled base	arms	legs	supplier	pattern	color						
Example	LC-	EE	-	MWW	-	01	-	NA	-	N	ENNIS	LOFT	AQUA

NA, AS, AD, FT, FG, FD, AZ, FZ

Fabrics
See the fabric chart
Logiflex grade

Accessories

SIT - Electrical Accessories

QIIP

Transmitter for iPhone

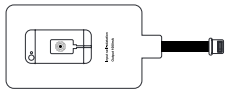

- Receiver for phones without Qi technology;
- For wireless charge devices;
- Adapter for Apple lightning port.

Code	\$	Description
QIIP	122	

CQI

Wireless Charger

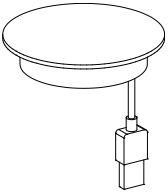

- Wireless air charger;
- Works with Qi compatible devices;
- 59" USB cable with USB wall charger;
- Finish: Black, White.



Code	\$	Description
CQIBL	128	Black
CQIWH	128	White

MH3D

Connectivity unit

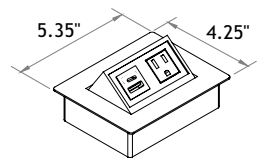

- Retractable connectivity unit with 1 electrical outlet and 1 dual charger USB-a+c;
- 120" power cable with electric plug;
- Finishes: Satin Nickel, Black and White.



Code	\$	Description
MH3DSN120 449		Satin Nickel, 120" power cable
MH3DBL120 449		Black, 120" power cable
MH3DWH120 449		White, 120" power cable

BA-INAT

Armchair Fastener

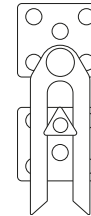

- Instructions : Sectional connector has two parts included in each connector. One mounts on each section, and then are joined by pushing the pieces together. To separate, just lift the catch fork, it will then swivel down out of sight.

Code	\$	Description
BA-INAT	14	

As our product line is constantly evolving and expanding, we recommend that you visit logiflex.ca for updates.

logiflex

1235 St-Roch N., Sherbrooke QC J1N 0H2 Canada
T : 1.877.864.9323 | F : 1.800.474.7830 | logiflex.ca

March 27, 2025 | USA

LOGIFLEX | SEATING

