

XTENSION

Price List
USA 2025



logiflex

Table of Contents

Introduction	3	Supports	55
Product Map	5	Legs	56
Our social responsibility	8	Layering Surface Support	62
Conditions of Sale	8	Brackets and Stiffeners	64
Manufacturing Standards	9	Pedestals	69
How to Use the Price List	10	Independant Pedestals	70
Appendix A: Colors and Finishes	11	Mobile Pedestals	78
Appendix B: Surfaces and Molding Edges	14	High Pedestals	80
Appendix C: Wood Grain	15	Benches	82
Appendix D: Pedestals and File Drawers	16	Storage	84
Appendix E: Calculation and Use of Electrical Components	17	Credenzas for Height Adjustable Table	85
Appendix F: Locks	20	Bookcase for Height Adjustable Table	87
Appendix G: Electrical Wire Management Solutions	21	Storage Towers	88
Appendix H: Surface Support	24	Sliding Storages	89
Walls and Panels	25	Storage Towers	90
Power Walls	26	Islands Stations	93
Division Panels	31	Islands Stations	94
Panel Accessories	38	Islands Stations with Bookcase	95
Surfaces	49	Islands Stations with Lockers	96
Rectangular Surfaces	50	Accessories	97
D Surfaces	52	Keyboard Trays	99
Collaboration Surfaces	53	CPU Holders	100
Privacy Corner Screen	54	Computer Monitor Brackets	101
		Miscellaneous Accessories	103
		Electrical Accessories	105



Introduction

The Xtension furniture collection

Update Summary

The Xtension price list presents these principal modifications:

DATE	SECTION	MODIFICATIONS
March 3, 2025	All the Price List	<ul style="list-style-type: none"> All prices have been increased by approximately 3%.

Previous updates:

DATE	SECTION	MODIFICATIONS
December 11, 2024	Accessories	<ul style="list-style-type: none"> Price adjustment for CT24 and CT118 cable trays.
December 10, 2024	Accessories	<ul style="list-style-type: none"> Addition of the Shift double monitor arm with docking: SHIFT-2A.
October 16, 2024	Independant Pedestals	<ul style="list-style-type: none"> Removal of BLEO.
October 8, 2024	Storage	<ul style="list-style-type: none"> Addition of Xtension credenzas and bookcase : KOEP, OKEP & BBLEP.
June 26, 2024	Panel Accessories	<ul style="list-style-type: none"> Addition of the glass divider EGS.
March 1, 2024	All the Price List	<ul style="list-style-type: none"> All prices have been increased by approximately 5%.
November 22, 2023	Appendix A	<ul style="list-style-type: none"> Removal of high gloss finish.
	Electrical accessories	<ul style="list-style-type: none"> Addition of the wire management system BE-WMS-32 & BE-WMD-32. Addition of port USB A & C SQC. Removal of the power bar F-714.
July 4, 2023	Electrical accessories	<ul style="list-style-type: none"> Chicago Code : Certain electrical components are now marked prohibited or restricted for orders in chicago. (USA pricelist only).
May 22, 2023	Panels	<ul style="list-style-type: none"> Addition of new dimensions for panels PANLL, PANLR, PANT and PANX.
February 1, 2023	All the Price List	<ul style="list-style-type: none"> All prices have been increased by approximately 5%. Transition from 6 to 14 grades of fabric. New certification Indoor Advantage Gold (replace Greenguard).

Introduction



Product Map

Walls and Panels

[See the Xtension specifications guide here](#)

Power Walls

Division Panels

p.34

Panel Accessories

p.38

Surfaces

Rectangular Surfaces

p.48

Privacy Corner Screen

p.52

Introduction

Product Map

Supports

[See the Xtension specifications guide here](#)

Legs

p.54

Layering Surface Support

p.60

Brackets and Stiffeners

p.62

Pedestals

Independant Pedestals

p.68

Mobile Pedestals

p.76

High Pedestal

p.78

Introduction

Product Map

Pedestals (following)

[See the Xtension specifications guide here](#)

Benches p.79

Storage

Xtension Credenzas p. 85

Xtension bookcase p. 87

Storage Towers

Sliding Storages p.84

Storage Towers p.85

Islands Stations

Islands Stations p.88



Our social responsibility

At Logiflex, we have chosen to be a responsible North American manufacturer by implementing initiatives for sustainable development. As much as possible, we source local materials and partner with suppliers who prioritize clean manufacturing processes. We also consolidate goods during transport to reduce our fuel consumption and we continually make changes that help reduce our waste production.

The company is ISO 9001 certified.

You can consult our eco-responsible approach as well as all our certifications in the [Certifications](#) section of our website. Find out how our products can help you obtain LEED credits and the Logiflex products that are Indoor Advantage Gold certified.

Conditions of Sale

Prices

The amounts listed in this document are suggested retail prices and may be changed without notice. Applicable taxes are not included. If you have an open and active account with Logiflex, merchandise will be invoiced at the prices prevailing at the time of shipment. A deposit may be requested if the opening of your account has not been completed or if your account has become inactive.

Terms of Payment

Net 30 days F.O.B. Sherbrooke, Quebec. The invoice will be assigned the shipping date and is payable 30 days from that date. Logiflex remains the owner of the merchandise until the invoice is paid in full.

Customized Products (Special Items)

Price requests for customized products or special items can be submitted via the ["Member Zone"](#) section of our website, at www.logiflex.ca. Our quotations department will study your request and send you a quotation and a technical drawing for approval as soon as possible. Modifications to quotations or technical drawings can be requested the same way. The approved quotation(s) and technical drawing(s) can then be attached to your purchase order.

Orders

An official purchase order must be issued for all purchases. Your purchase order must contain the following information:

- Your company letterhead
- Your reference number
- The delivery address (with contact name and phone number)
- The complete product codes
- Furniture colour(s)
- Quantities
- Descriptions
- Retail prices and net prices
- Project registration number (if applicable), and your approved quotation and technical drawing (for special items).

Please note that a quotation cannot serve as a purchase order.

Returns

All returns must first be approved by Logiflex. If the return is accepted, a Logiflex customer service representative will send you an official return authorization form in order to facilitate procedures between you, the carrier, and the Logiflex merchandise reception clerk. Additional costs for shipping or other expenses may be applied following any merchandise returns.

Modifications and/or Cancellations

You have 24 hours from the time we acknowledge receipt of your order to make any requests for corrections or modifications. You may cancel your order during this same 24-hour period. If you would like to modify or cancel your order after this 24-hour verification period, please check with a Logiflex customer service representative. Orders cannot be changed or cancelled if production has already begun or if Logiflex has already received the raw materials.

Liability

Logiflex's liability ends once the carrier has delivered all items in good condition. A delivery receipt signed by the customer acknowledges that the shipment is complete and has been received in good condition.

Claims

Logiflex recommends inspecting the shipment before signing the carrier's delivery receipt. You must notify Logiflex of any incomplete shipments or damaged furniture within 30 days after delivery. Requests to replace damaged products can be made via the ["Member Zone"](#) section of our website, at www.logiflex.ca. Our after-sales service department will examine your request and help you correct the situation.

Changes

Logiflex reserves the right to make changes to the materials, accessories, components, specifications and designs, and to discontinue collections and/or models, at any time and without prior notice.

Storage and/or Shipping Fees

According to the terms Logiflex set forth in the transport policy. The transport policy can be consulted online in the Private Space.

Items Delivered Disassembled

Some items are delivered disassembled, such as empty desks, empty returns, bridges, arched tables, D, P or Q tables, lateral tables, end tables, hook tables, corner tables and extended-corner tables. To order these items assembled, add a \$100 list price. Contact Customer Service for details.

Warranty

Logiflex guarantees to the original purchaser that Logiflex products are free from defects in design, materials and workmanship for the product's lifetime, with certain exceptions.

You may consult the full warranty on the website: [Logiflex Warranty](#)

Introduction



Manufacturing Standards

Product Dimensions

For display purposes, the furniture dimensions represented in the price tables on each product page are rounded to the nearest whole number.

Furniture Construction

- All desktops and legs are 1" thick laminate;
- Fronts and backs are 5/8" thick laminate.

Handles

Handles are included for all Xtension furniture with doors. The standard handle, when included, is the H071BL handle (black). Please refer to the [Accessories](#) section for the list of handles available from Logiflex.

Space for surfaces

All surfaces offer the option of having a 1.5" space to allow wiring to pass through. Please refer to the different product pages to see and understand its operation.

Locks

Locks are included for all pedestals, lateral file drawers, cabinets and wardrobes. It is possible to specify a finish other than the black standard. Please refer to the [Accessories](#) section at the end of this price list to find out about the different finishes available from Logiflex.

Pedestals

All drawers are made of black Medium density fiberboard (MDF) with an average thickness of 7/16". Utility, file and lateral file drawers have full extension slides. The lateral file drawer has a load capacity of 150lbs while the utility and file drawer have a load capacity of 100lbs.

Drawer Fronts

A PVC strip 1.5 mm thick is systematically applied along all drawer front edges.

Wood Grain

The wood grain is always vertical on fronts, furniture doors, walls and panels. Logiflex cannot guarantee that the wood grain will match up on the different parts of a same surface.

Finishes

You must specify the desired finish(es) for each item of furniture ordered. Please make your selection(s) from the Logiflex chart.

Levelers

All furniture items sit on 1" in diameter, white nylon levelers, allowing for up to 1-1/4" height adjustment. The standard finished height for work surfaces is 29".

Introduction

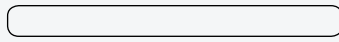

How to Use the Price List

Interactive Menu

- Product line: Sliding Storages
- Product group: Storage towers

Product name: Cabinet with drawers

Product code: ARUFL, ARUFR

Product image: Two 3D wireframe views of a cabinet with dimensions A, B, and C.

Product Information: Color Combination (Top, Front, Base)

Manufacturing Standards: Cabinet with 1 door, 1 utility drawer and 1 lateral file drawer:

- 1 cabinet section with 1 adjustable shelf for the 42"H cabinet with drawers, 2 adjustable shelves for the 54"H cabinet with drawers;
- 1 utility drawer;
- 1 lateral file drawer;
- Handles H071BL;
- Lock;
- White nylon levelers.

Additional Product Information and Notes:

- Remove lock as option, no extra charge.
- Specify if different handle desired (no extra charge, see p. XX).

Options: Tab with notch for wire management (MG \$0)

Prices:

Dimensions			
A	B	C	
20	18	42	1432
24	18	42	1458
20	18	54	1453
24	18	54	1480

Ordering instructions:

	ABC	ARUFL ARUFR	MGRL MGLR MGRR MGN (std)	H071BL (std)	N LKSN LKBL (std)	
Series	XT					
Dimensions						
Product			Tab with notch for wire management	Handle	Lock	
Example	XT	201842	ARUFR	MGN	H071BL	LKBL

June 13, 2022 | Canada | LOGIFLEX | XTENSION | 84

Standard Product Code: Details as per the price listed

Options, if desired (\$): Always after the product code

Introduction



Appendix A: Colors and Finishes

How to specify your laminate colors

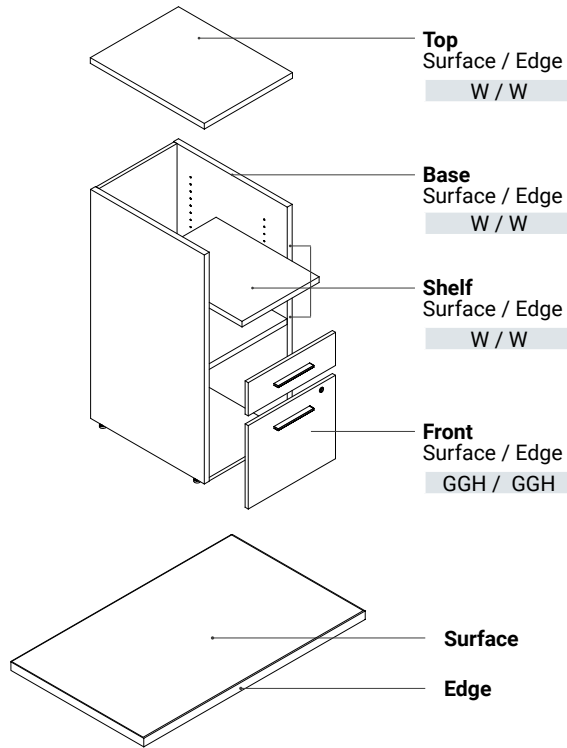

Metal Finishes

- SN** Satin Nickel
- BL** Black
- WH** White

Availability Chart

FINI FINISH	CODE	COLOR COULEUR	THICKNESS ÉPAISSEUR			HPL STRATIFIÉ	PANVAL CODE
			5/8"	1"	1-5/8"		
OMNIA	DOO	Dosha	•	•		•	K77
	COO	Cosmos	•	•		•	K78
AURA	GIA	Ginger Root Gingembre	•	•		•	H72
	HAA	Haze Brume	•	•	•	•	H57
	OHA	Ohm	•	•	•	•	K69
	STA	Storm Tempête	•	•	•	•	H58
	TUA	Tundra	•	•		•	H75
LYRA	ASY	Asha	•	•		•	K47
	CIY	Chiffon Mousseline **	•	•	•	•	K60
	KAY	Kali	•	•		•	K46
SUPERMAT	IGS	Ingot grey Gris lingot	•	•			828
	WGS	Willow grey Gris saule	•	•			802
DOLOMITE	AU	Audacity Audace **	•	•	•	•	241
	B	Jet Black Noir intense *	•	•		•	888 S405-CA
	BC	Brown cherry Cerisier brun	•	•	•	•	207
	C	Slate Ardoise *	•	•		•	801
	DR	Driftwood Bois de rive	•	•		•	744
	G	Mink Grey Gris vison	•	•		•	805 OU-927
	NM	Natural Maple Érable naturel	•	•	•	•	206
	PO	Porto	•	•		•	913 OU-648
	SW	Smoked Walnut Noyer fumé	•	•	•	•	G21
	TO	Tobacco	•	•		•	205
	W	Polar White Blanc polaire	•	•	•	•	555 459-CA
WK	Whisky	•	•	•	•	245	

* Non recommended color for work surfaces.

** For conference tables with 2 or more parts, we do not recommend the use of colors with irregular and contrasted woodgrain like Chiffon, Audacity or Coastal Pear as it results in a pronounced wood grain mismatch.

Colors may vary from 2% to 5% between tfl and hpl laminates due to different technical applications.

See our complete [Colors & Finishes Guide](#)

New

Introduction

Appendix A: Colors and Finishes (following)

12 Wood Stains

Logiflex offers varnish and stain selection among the following 12 colors on all wood applications.

Knots and color variation can occur between different wood components of the same piece of furniture, or between different pieces of furniture. This variation is due to the natural characteristics of the wood, and is more contrasting for pale wood colors like Golden Wheat.



WW White Wash



GW Golden Wheat



SD Sand

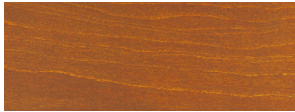

AT Apricot

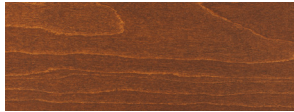

PN Pecan

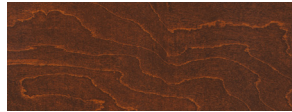

BR Brandy



CT Chestnut



CF Coffee

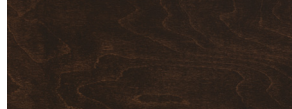

ES Espresso

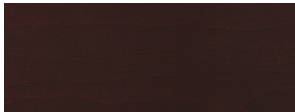

BO Bordeaux

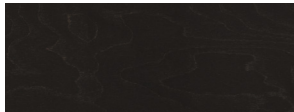

BW Black Wash

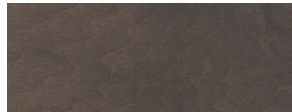

BK Bark

- Due to its natural properties of wood, grain pattern and finish color variation can be expected.
- Although Logiflex offers great matches from laminate to wood, they are not exact due to grain pattern and sheen variation from laminate to wood. They coordinate throughout a floor plan, however we recommend they not be utilized on the same piece of furniture. See the [Closest match - Wood stain / Laminate](#) guide.
- Adding a new product to an existing installation might result in color variations due to light exposure.
- **RAW** and **HATLEY** legs have a wood part.

3 Felt Colors for hexagonal tiles

Hexagonal felt tiles are 12" x 10-25/64" tiles covered with felt and are offered in a choice of 3 colors.



BL Blue

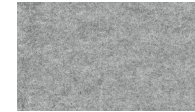

LG Light Grey



DG Dark Grey

10 Fabrics for Tackboards

You must specify the fabric when the item requires it. Please refer to the Logiflex fabric guide to make your choice.



TBFRME Medium Grey



TBFRGR Grey Mix



TBOFTH Thermal



TBOFCO Coal



TBOFTI Tidal

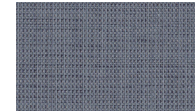

TBOFHY Hydro



TBOFLA Lava



TBOFFO Fossil

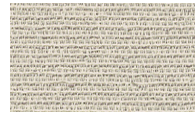

TBSPAL Alabaster



TBSPOB Obsidian

Cushions Fabrics

[See the Logiflex Graded-in List](#)

Introduction



Appendix A: Colors and Finishes (following)

15 Colors for Ezobord Sound Absorbing Overhead Screen

The Ezobord sound absorbing overhead screens are used to give an extra touch of privacy with a unique style and are offered in a choice of 15 colors.

2 Colors Available



BG07 Bold Gray



MG10 Moss Green

13 Other Colors Available, if Order 6 and More

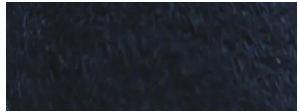

PB09 Pure Black

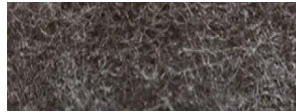

CG06 Charcoal Gray



SG04 Silver Gray



CW04 Classic White

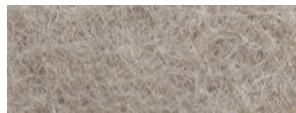

DS10 Desert Sand



SD18 Sunny Days

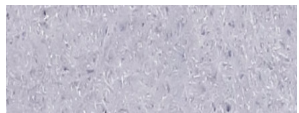

PI14 Polar Ice



OB14 Ocean Blue



EG11 Elephant Gray



TB35 Tree Bark

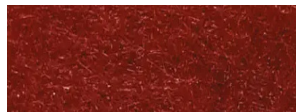

BR34 Brick Red

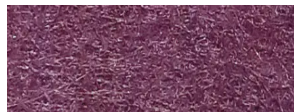

GV36 Grape Vine

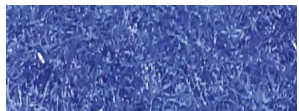

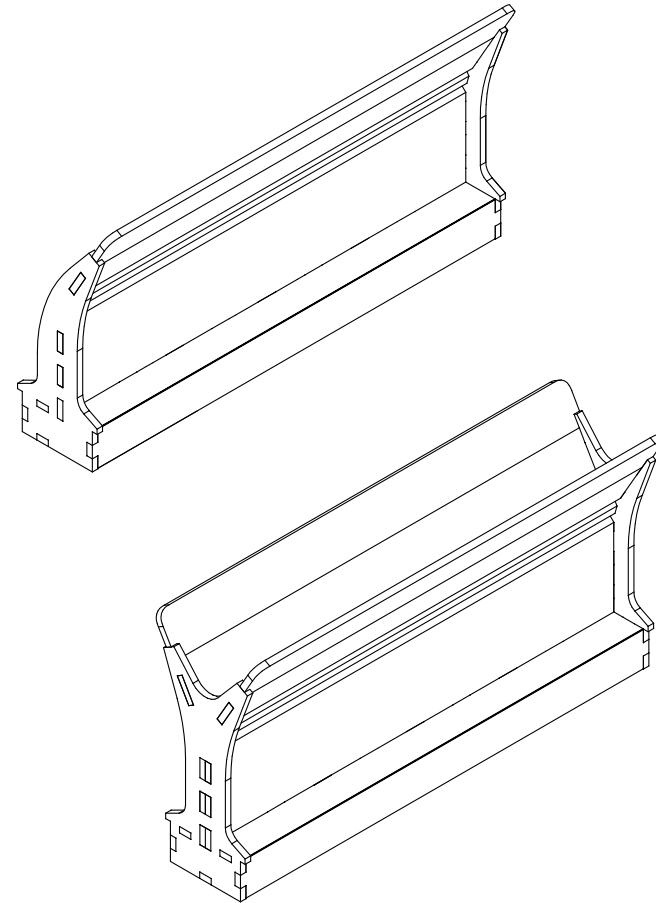

RB08 Royal Blue



• These colors only apply to sound absorbing overhead screens products with codes **OHSS** or **OHSD**.



Appendix B: Surfaces and Molding Edges

SERIES	PREVIEW	COMPONENT	MATERIAL	EDGES / MOLDING
XT		1" surface	Thermofused laminate (TFL) - 1" high-density particle board.	1.5 mm polyvinyl chloride (PVC)
		Front and back	Thermofused laminate (TFL) - 5/8" high-density particle board.	1.5 mm polyvinyl chloride (PVC) on showing surfaces and 0.5 mm polyvinyl chloride (PVC) on non-showing surfaces.

Introduction



Appendix C: Wood Grain

Wood grain runs lengthwise on surfaces and vertically on drawers, doors and legs.
See image below for wood grain direction placements.

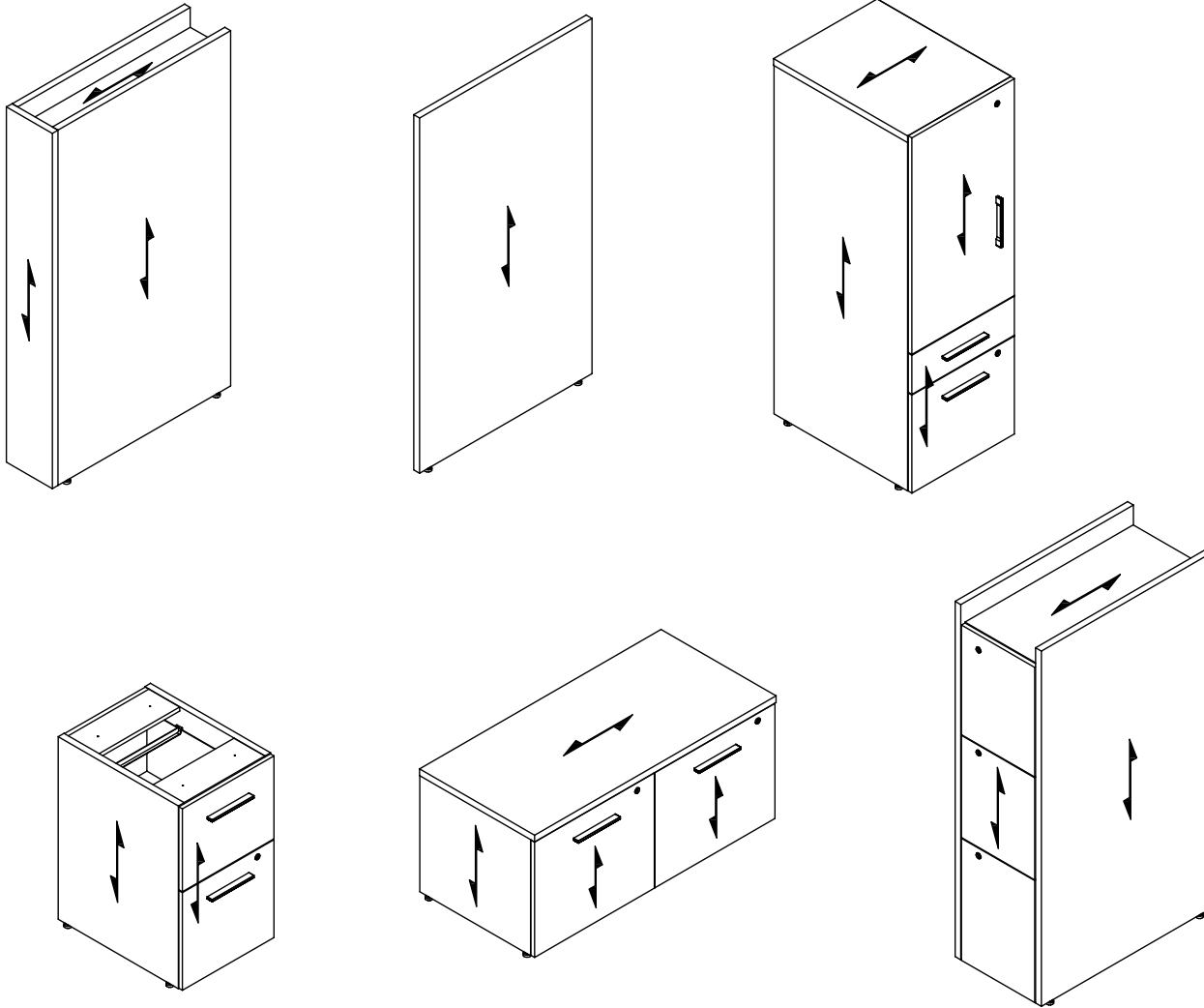

Introduction



Appendix D: Pedestals and File Drawers

E and F Pedestals

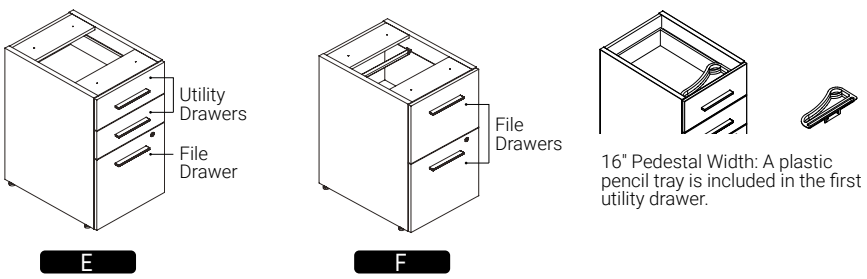

File Drawers

File drawers can receive either legal or letter formats. Please refer to the illustration below.

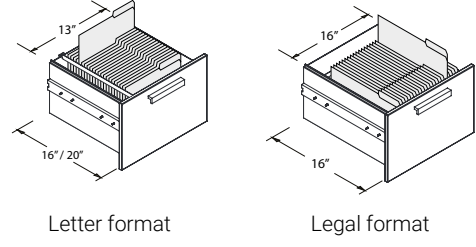

Lateral File Drawers

Lateral file drawers can receive either legal or letter formats. Please refer to the illustration below.

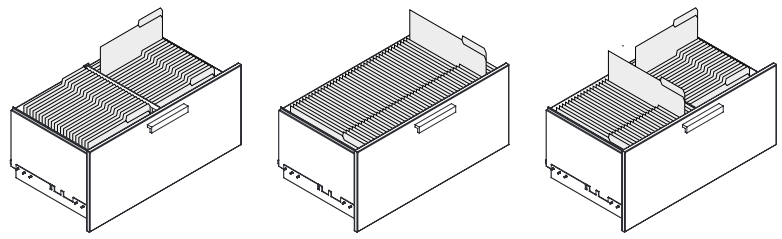

Legal and Letter formats

30" and 36" file drawers can accommodate 2 rows of files.
42" file drawers can accommodate 3 rows of files.

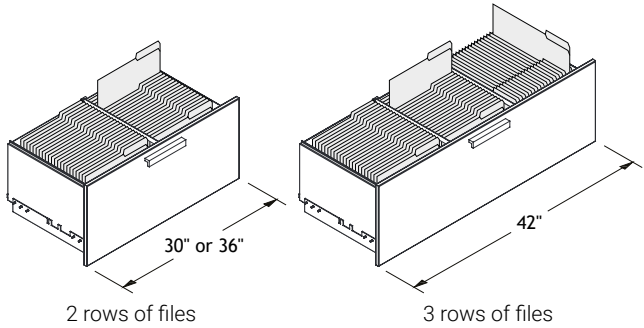

*For solidity purposes, ensure all files are suspended.

Appendix E: Calculation and Use of Electrical Components

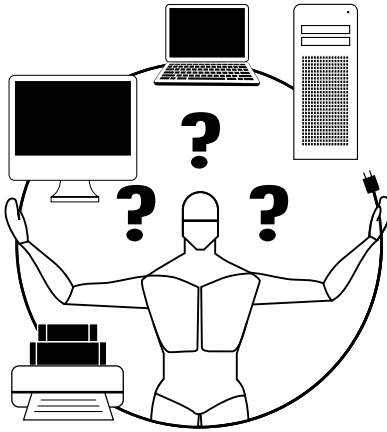

An Introduction to Calculation and Use of Electrical Components

Most people are uncomfortable with anything related to electricity. This step-by-step guide is intended for people who are not familiar with electrical installations but who have to specify what system they need when ordering furniture. In this guide, you will learn how to choose and specify the electrical components required for your projects. The list that follows illustrates and identifies each product and describes its applications.

The electrical components are all recognized by the Underwriters Laboratory (UL) as office furniture accessories and are manufactured according to Canadian Standards Association (CSA) and UL electrical standards.

Note: All electrical connections must be performed by a certified electrician.

By following these 3 simple steps, you can easily determine the number of circuits required to ensure safe use of your electrical system.

1. Determining the Number of Amperes Required
2. Calculating the Total Amperes
3. Determining How Many Circuits You Need

STEP 1: Determining the Number of Amperes Required

What is Amperage

An Ampere (Amp or A) is a unit for measuring the rate at which electric current flows. All electrical equipment has an amperage rate. By following these few simple steps, you can easily determine the number of circuits required to ensure safe use of your electrical equipment.

Determine the Number of Amperes Required

On your computer or other electric devices (ie: monitor, central processing unit, printer) find the plate that provides the technical specifications as follows:

Input: 120V - 1.8A.

If you cannot locate this information on the machine, you will probably find it in the user manual.

Here are a few examples of how many Amps some equipment may consume. Please note that these are examples and the number of amperes may vary from one machine to another.

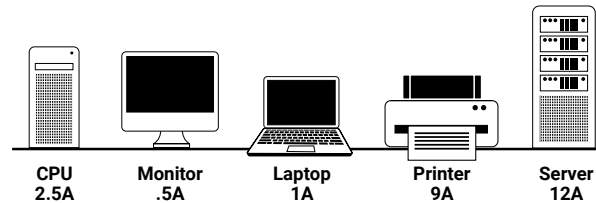

Electrical System Capacity

Our electrical system is designed for circuits of 20 amps each. This includes electrical components such as computers, printers, laptops, monitors, server or other devices.

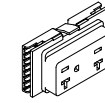

20A

A single Duplex has a maximum capacity of 20 A



Each power block can hold 2 Duplex

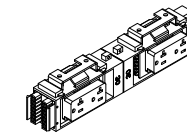

Each power block can hold 4 Duplex



If the duplexes are connected to the same circuit, the capacity is divided between them. For example, 3 duplexes connected to the same circuit have a total capacity of 20A.

Introduction

Appendix E: Calculation and Use of Electrical Components

STEP 2: Calculating the Total Amperes

Add the Amperes

Add the number of amps for each machine. In our example, there are 4 CPUs at 2.5A per computer, 4 monitors at 0.5A and one printer at 9A.



$$2.5A + .5A + 2.5A + .5A + 2.5A + .5A + 2.5A + .5A + 9A = 21A$$

The total number of amperes used in this example equals to 21A.

Divide by 16

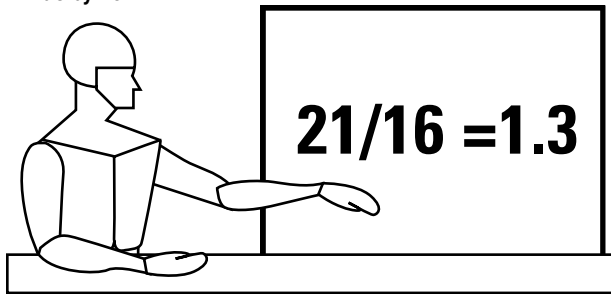

Most machines and computers used in offices or schools are used continuously for many hours at a time. In this type of situation, national electrical codes usually limit circuits at 80% of their capacity of continuous use. Our electrical system is designed for circuits of 20 amps each. So 80% of 20A is 16 Amps. You must therefore divide the total number of amperes calculated by 16.

STEP 3: Determining How Many Circuits You Need

In most cases, this number will contain decimals. Round up to the next whole number, and this will be the number of circuits required for your equipment to run safely. If the number obtained is higher than 4 (the maximum number of circuits for a system), you must reduce the total amperage or add another electrical system. Continuing with our example, the 1.3A is rounded up to 2A.

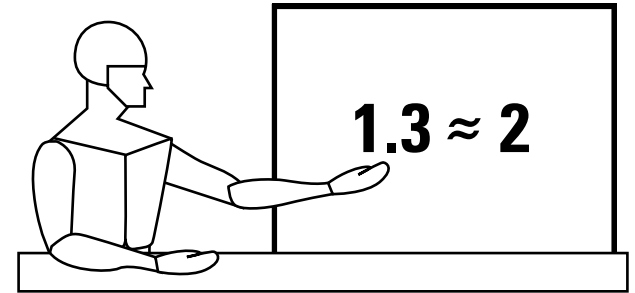

Here is one possible configuration. Using 5 power blocks joined together with junction cables, only 2 circuits are being used. The 4 workstations would be on the first circuit for a total of 16 amps. The printer would be on the second circuit.

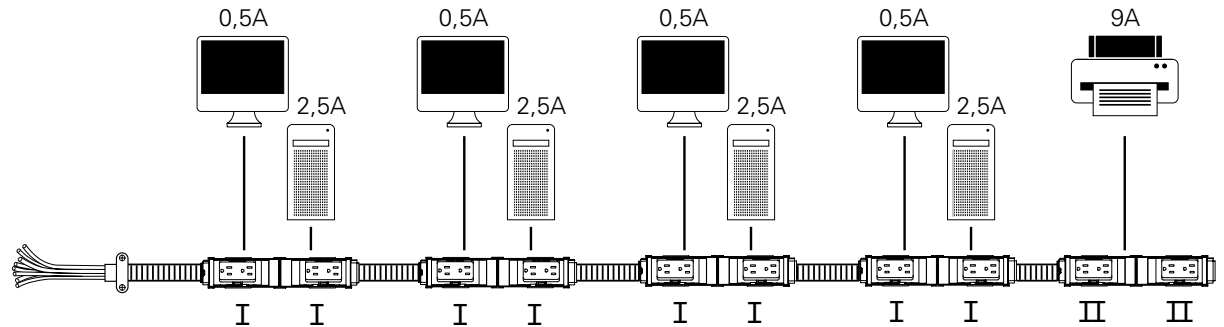

Appendix E: Calculation and Use of Electrical Components

8 Wire, 4 Circuit (3+1) Power Block

- Duplex are interchangeable permitting any required circuit combination;
- Blocks for single or double sided applications;
- Complies with National Electric Code;
- UL Listed/Recognized.

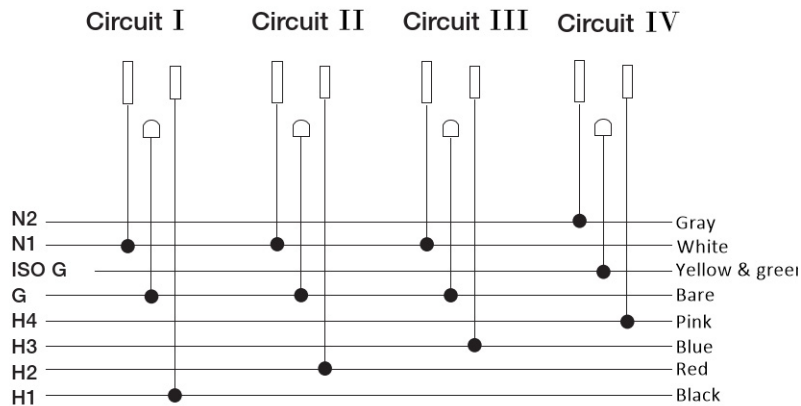
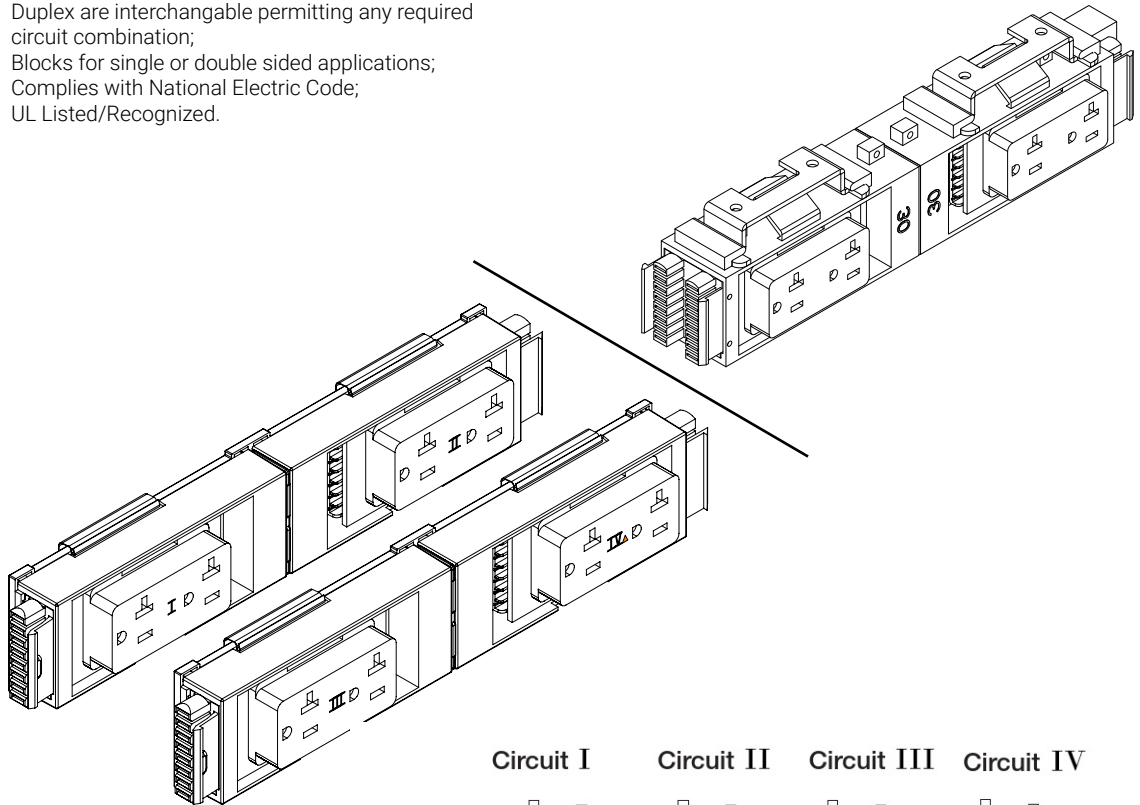

Starter Cable with Hardwire



- 4 circuit starter cable with hardwire at one end;
- 4 circuits rated for 20 AMP each;
- Available in lengths from 12" to 180";
- Whip end to be connected to building power by an electrician.

Starter Cable with Plug

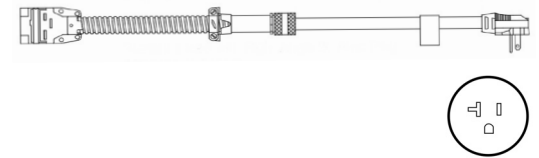

- 1 circuit starter cable with 20A electrical plug;
- Circuit rated for 20 AMP;
- Available in lengths from 36" to 180".

Junction Cable

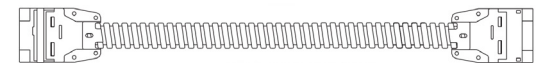

- 4 circuit cord;
- All circuits rated for 20 AMP;
- Available in lengths from 12" to 216".

Introduction

Appendix F: Locks

E1

[See the E1 lock guide here](#)
[See the instruction videos of the E1 lock](#)

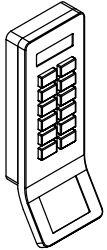

Features:

- Keypad with backlight for easy distinction;
- Wrong code or illegal card alarm;
- Code combination ranging from 1 to 9 digits for multiple possibilities;
- Private and public mode;
- Stainless steel material;
- External power back up.

Lock/Unlock by Master or User Card:

- Scan the master card near the instruction area. The green light comes on with a beep and the lock is unlocked.
- Permanent code mode: scan the card. The red light comes on with 2 beeps and the lock is automatically locked.
- One-time code mode: after unlocking by user card, the lock is in unlocked state.

Power supply	3 x AA alkaline batteries
Card type	EM card (125KHz)
Battery life	12~15 months
Static current	≤20μA
Dynamic current	≤200mA
Working temperature	-15 ℃ ~ +55 ℃
Working humidity	20 ~ 95%RH
Alarm voltage	3.7±0.2V
Door thickness	≥ 1mm

Program/Change Master Card:

- After initialization, scan a card near the instruction area.
- After 3 long beeps, the programmed card becomes master card.
- During the flashing period of the LED, the other 2 cards can be programmed up to 3 times max.
- The other 2 cards are needed in the future if one or 2 cards are lost.
- The programming procedure is: * - master card - # new master card.
- After programming a new master, the lost master card is deleted.

Delete Permanent Code:

- Tap the master card on the inductive areas three times. After 3 short beep sounds the permanent code is deleted.

Lock/Unlock by Permanent Code:

- Digital code (max 9 digit) followed by #
- After being unlocked for five seconds, a red light and two beep will sound while the locking automatically.

E2

[See the E2 lock guide here](#)
[See the instruction videos of the E1 lock](#)

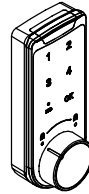

Features:

- Tactile buttons and indicators sound for a premium experience;
- Automatic alarm after 4 attempts;
- 4 digit combination for 10,000 possibilities;
- For shared use (public);
- Low consumption of battery (more than 5,000 uses);
- Easy button cell battery change.

Program your Personal Code:

- Lock: Enter a 4-digit code and turn lock button to lock. Memorize this code. This code will be valid for one use only.
- Unlock: Enter this 4 digit code again and turn lock button to unlock. Do NOT press OK.

Forgotten Code:

- Note the serial number located on the side of the lock.
- Contact Logiflex to obtain the master code for your lock.
- Enter the 8-digit master code and press OK.
- Turn the lock to open.

Master Key Forgotten Code:

- Contact the person in charge of the master key.
- Insert the key and press OK.
- Turn the lock to open.

Master key sold separately, see [Accessories](#).

CMLK

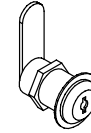

Features:

- Key lock for use in lockers.
- Lock numbers are assigned randomly. Identical keys not available.
- The CMLK lock is different from the standard Logiflex lock. Additional keys and master keys are available on request. Mention that it is the locker lock.
- Finish: Chrome.

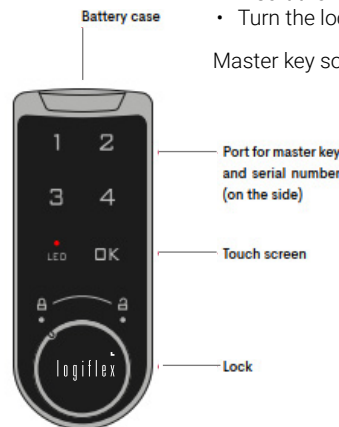

Introduction

Appendix G: Electrical Wire Management Solutions

Example : Power Wall PWL

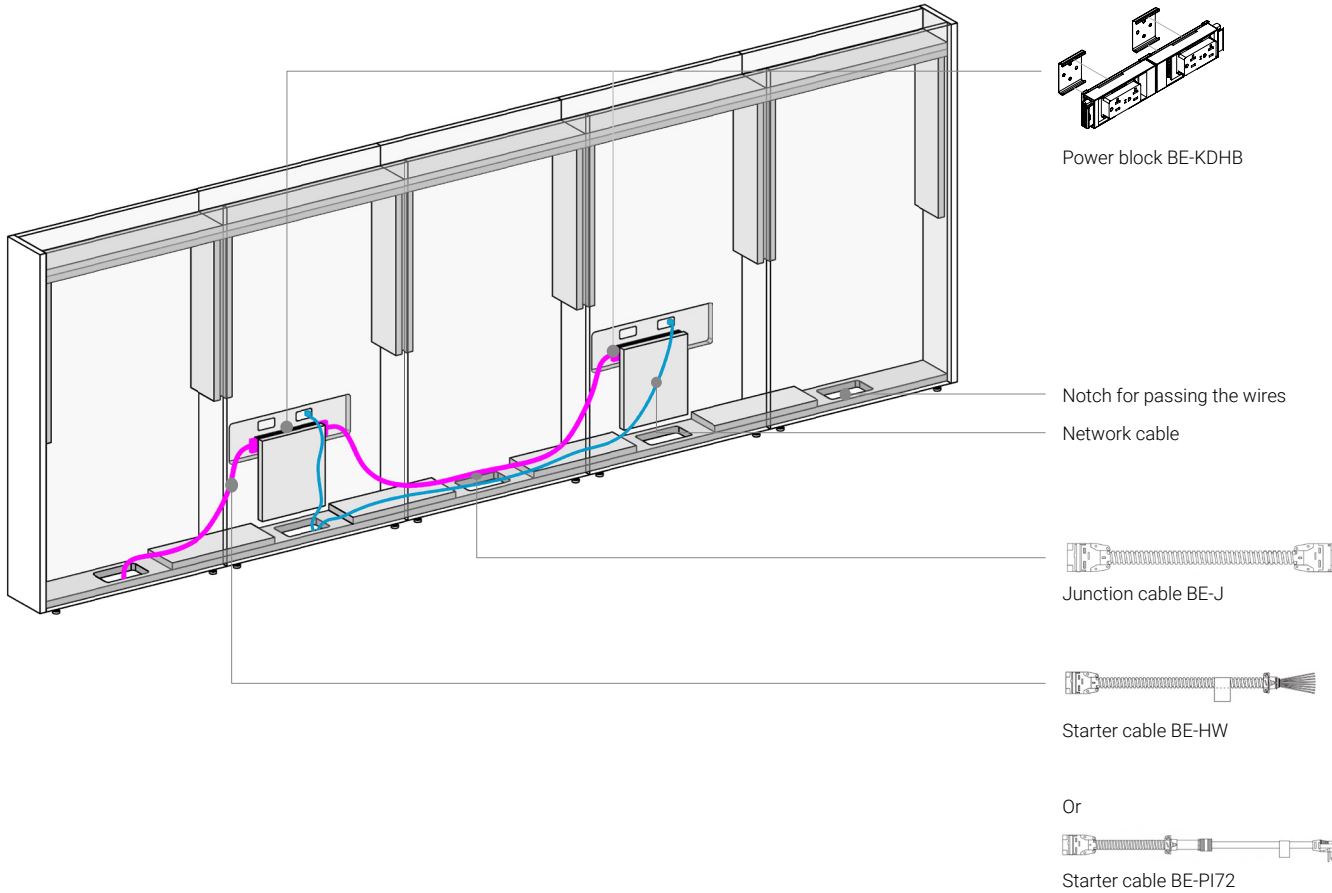

CHICAGO CODE

There is a specific norm about Chicago electrical components. Some of our products are approved, but not all of them.



If you see this logo in [Accessories](#), this means the product is **NOT** approved in Chicago. More info [here](#).

Introduction

Appendix G: Electrical Wire Management Solutions (following)

Example: Option 1.5" Space

Specify this option to allow a 1.5" space between the surface and panel for wiring to run below the surface.

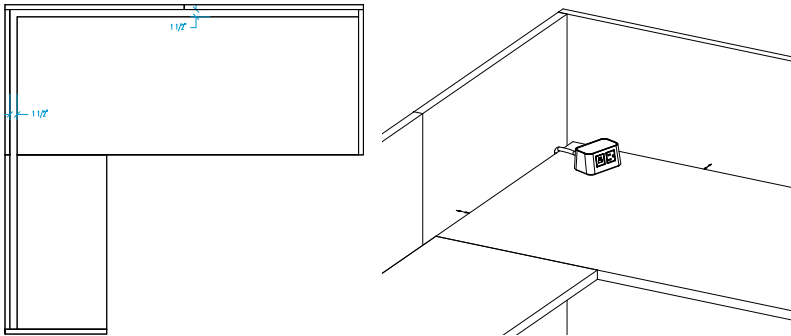

Example: IND Pedestal and High Pedestal

The pedestals have a 2.5' recess to pass wiring.

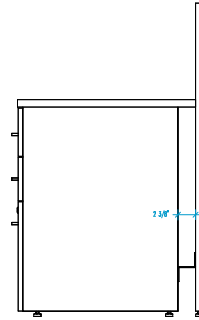

The pedestals have an open back for access to wiring, concealed with a removable panel on the cabinets and BB.

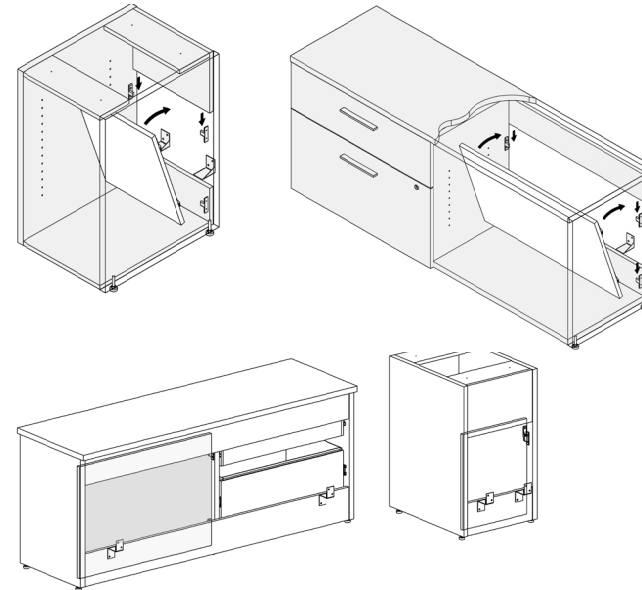

Example: Island Station

The island stations have a removable panel on the side where there is no storage, the removable panels are used to provide access to plugs.

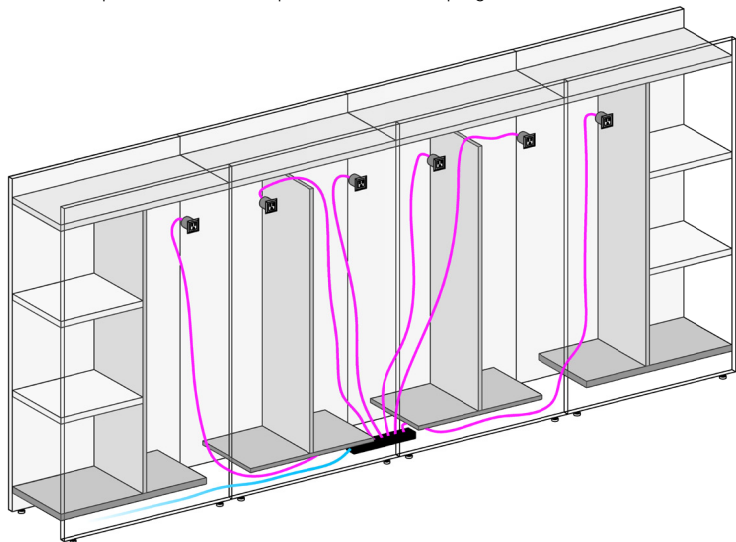

Introduction



Appendix G: Electrical Wire Management Solutions (following)

Example : Storage Tower

Storage towers can be specified with a recessed back by requesting a cutout on the right, left or both sides.

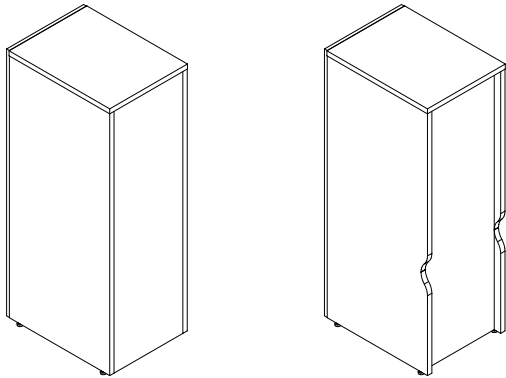

Example : Under the Surface

A metal cable tray can be installed on the dividing panels and power walls. It is recommended to install the cable tray with the help of the supports CNT01/02/03.

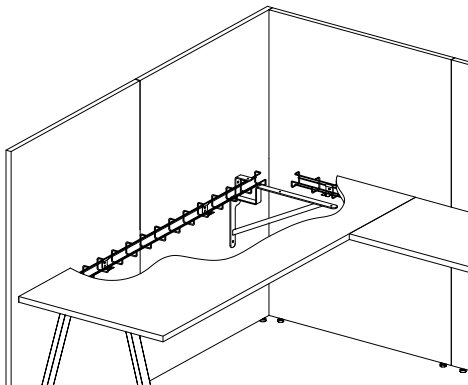

If a cable tray is specified under an Elevation Plus table, it is recommended to specify a CTCOVER to hide the cables.

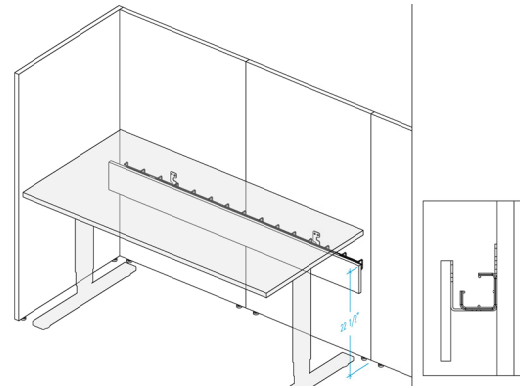

To pass wiring between dividing panels or in power walls, you must order a DSG and drill a 2.5" hole during installation.

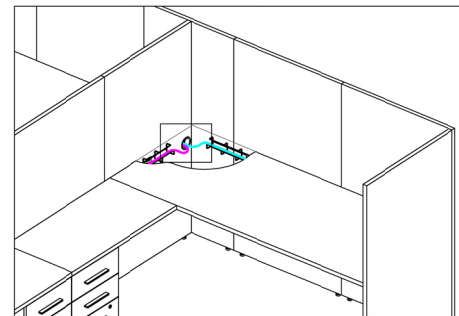
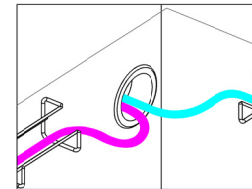



Appendix H: Surface Support

Example : Dividing Panel

The dividing panels are dependent on the furniture inside, here are the rules to follow according to the specification;

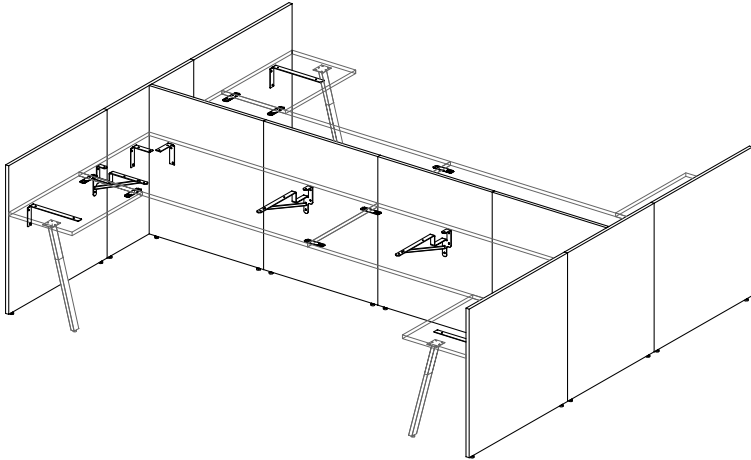

Example : Power Wall

Power walls do not need furniture to be supported, Elevation Plus tables should be used more;

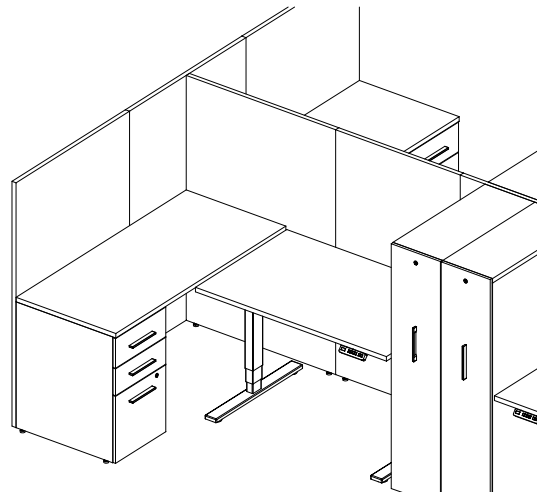
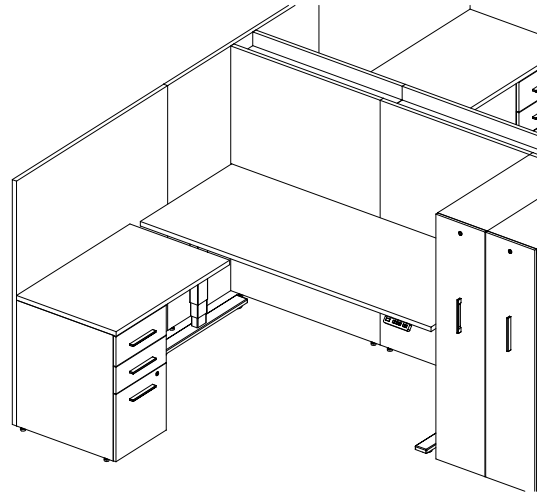

Walls and Panels

Power wall

PWL

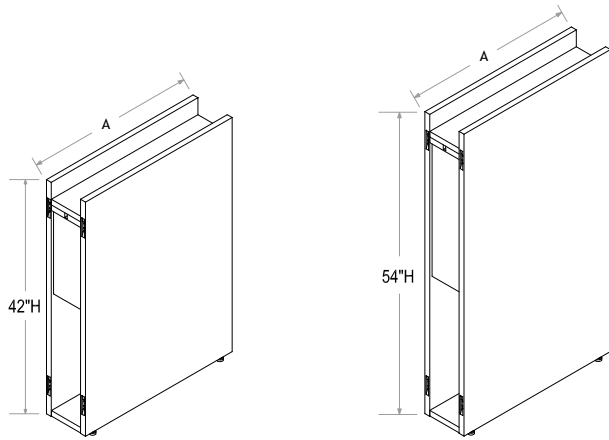

Options

Access panel with power block

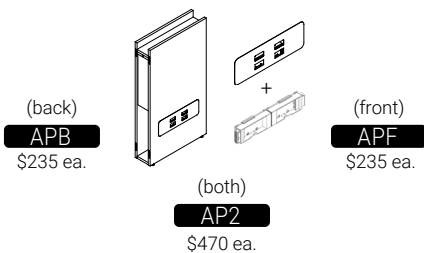

Manufacturing Standards

- Power wall with:
- 1" laminate frame with 6" interior space to allow the wiring to pass through;
 - Open bottom for wire management;
 - Open sides on the left and the right with connectors;
 - Connectors compatible with power wall or end panels only;
 - White nylon levelers;
 - Vertical wood grain.
 - Requires end panel when not connected to power wall
 - 8" thick

Non freestanding furniture.
 Refer to [Appendix H](#) for specification rules.
 End panels are needed to close the ends. [See p. 31.](#)
 Panel accessories sold separately.

Access panel with power block:
 The option comes with the empty power block and a metal access panel that is fixed to the power wall with magnets. The metal finishes are available in *Satin Nickel (SN)*, *White (WH)* and *Black (BL)*. Duplexes, telecom plates and cables are sold separately.

Prices

Dimensions	
A	B
24 42	750
30 42	824
36 42	925
<hr/>	
24 54	874
30 54	918
36 54	956

How to Order

Series	Dimensions	Product	Access panel	Metal	
XT	AB	PWL	APF APB AP2 N (std)	SN WH BL (std)	
Example	XT	2442	PWL	N	BL

Walls and Panels

T-shaped Power Wall with dividing panel - 42"H

PWLT - 42"H

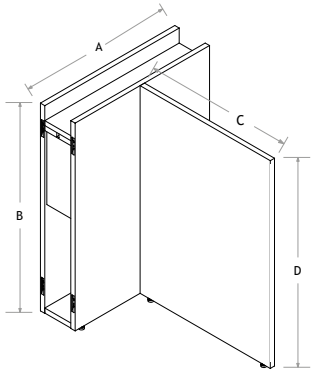

Options

Electric box with access panel

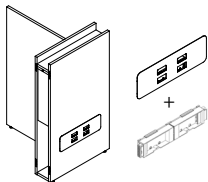

(back)

APB
\$235 ea.

Connector

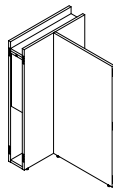

F
\$0

Manufacturing Standards

Power wall with:

- 1" laminate frame with 6" interior space to allow the wiring to pass through;
- Open bottom for wire management;
- Open sides on the left and the right with connectors;
- Connectors compatible with power wall or end panels only;
- White nylon levels;
- Vertical wood grain.
- Requires end panel when not connected to power wall
- 8" thick

Non freestanding furniture.

Refer to [Appendix H](#) for specification rules.

End panels are needed to close the ends. [See p. 31.](#)

Panel accessories sold separately.

Access panel with power block:

The option comes with the empty power block and a metal access panel that is fixed to the power wall with magnets. The metal finishes are available in *Satin Nickel (SN)*, *White (WH)* and *Black (BL)*. Duplexes, telecom plates and cables are sold separately.

Power block with finishing panel option not available on sides with division panel and for the *13" and *21" walls.

Prices

Dimensions				
A	B	C	D	
*13	42	12	42	831
*21	42	20	42	900
25	42	24	42	969
31	42	30	42	1074
37	42	36	42	1231

How to Order

XT	AB	PWLT	CD	APB N (std)	SN WH BL (std)	F N (std)
Series	Dimensions low wall	Product	Panel dimensions	Access panel	Metal	Front connector
Example XT	2142	PWLT	2042	N	BL	N

Walls and Panels

T-shaped Power Wall with dividing panel - 54"H

PWLT - 54"H

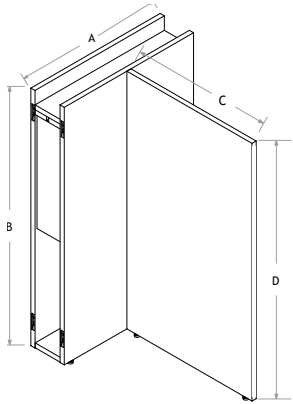

Options

Electric box with access panel

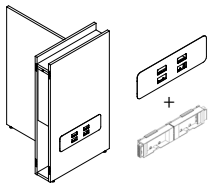

(back)

APB
\$235 ea.

Connector

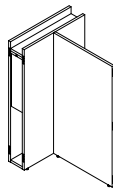

F
\$0

How to Order

Series	Dimensions low wall	Product	Panel dimensions	Access panel	Metal	Front connector	
XT	AB	PWLT	CD	APB N (std)	SN WH BL (std)	F N (std)	
Example	XT	2154	PWLT	2042	N	BL	N

Manufacturing Standards

Power wall with:

- 1" laminate frame with 6" interior space to allow the wiring to pass through;
- Open bottom for wire management;
- Open sides on the left and the right with connectors;
- Connectors compatible with power wall or end panels only;
- White nylon levelers;
- Vertical wood grain.
- Requires end panel when not connected to power wall
- 8" thick

Non freestanding furniture.

Refer to [Appendix H](#) for specification rules.

End panels are needed to close the ends. See p. 31.

Panel accessories sold separately.

Access panel with power block:

The option comes with the empty power block and a metal access panel that is fixed to the power wall with magnets. The metal finishes are available in Satin Nickel (SN), White (WH) and Black (BL). Duplexes, telecom plates and cables are sold separately.

Power block with finishing panel option not available on sides with division panel and for the *13" and *21" walls.

Prices

Dimensions				
A	B	C		
*13	54	12 42	1006	
*21	54	20 42	1074	
25	54	24 42	1099	
31	54	30 42	1168	
37	54	36 42	1386	
Dimensions				
A	B	C	D	
*13	54	12	54	1019
*21	54	20	54	1087
25	54	24	54	1149
31	54	30	54	1231
37	54	36	54	1337

Walls and Panels

X-shaped Power Wall with dividing panels - 42"H

PWLX - 42"H

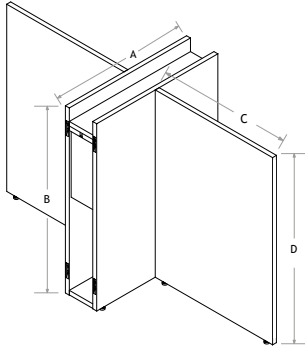

Manufacturing Standards

Power wall with:

- 1" laminate frame with 6" interior space to allow the wiring to pass through;
- Open bottom for wire management;
- Open sides on the left and the right with connectors;
- Connectors compatible with power wall or end panels only;
- 2 simple dividing panels, fixed to the center;
- White nylon levelers;
- Vertical wood grain.
- Requires end panel when not connected to power wall
- 8" thick

Non freestanding furniture.

Refer to [Appendix H](#) for specification rules.

End panels are needed to close the ends. [See p. 31.](#)

Panel accessories sold separately.

Power block with finishing panel option not available on sides with division panel.

Options

Connector

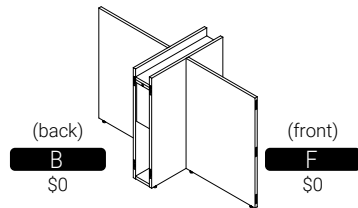

Prices

Dimensions			
A	B	C	D
13	42	12	42
21	42	20	42
25	42	24	42
31	42	30	42
37	42	36	42

How to Order

Series	Dimensions low wall	Product	Panel dimensions	Front connector	Rear connector
Example XT	2142	PWLX	2042	N	N

Walls and Panels

X-shaped Power Wall with dividing panel - 54"H

PWLX - 54"H

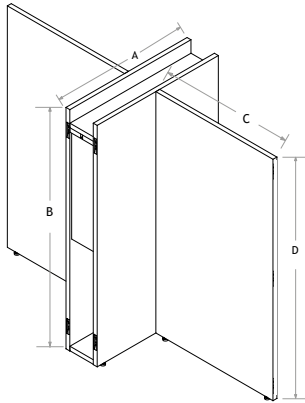

Options

Connector

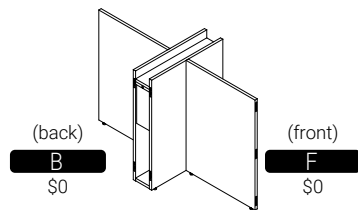

How to Order

	AB		CD		F N (std)	B N (std)
Series	Dimensions low wall	Product	Panel dimensions	Front connector	Rear connector	
Example	XT	2154	PWLX	2042	N	N

Manufacturing Standards

Power wall with:

- 1" laminate frame with 6" interior space to allow the wiring to pass through;
- Open bottom for wire management;
- Open sides on the left and the right with connectors;
- Connectors compatible with power wall or end panels only;
- 2 simple dividing panels, fixed to the center;
- White nylon levelers;
- Vertical wood grain.
- Requires end panel when not connected to power wall
- 8" thick

Non freestanding furniture.

Refer to [Appendix H](#) for specification rules.

End panels are needed to close the ends. [See p. 31.](#)

Panel accessories sold separately.

Power block with finishing panel option not available on sides with division panel.

Prices

Dimensions					
A	B	C	D		
13	54	12	42	1125	
21	54	20	42	1191	
25	54	24	42	1245	
31	54	30	42	1385	
37	54	36	42	1531	
<hr/>					
13	54	12	54	1218	
21	54	20	54	1299	
25	54	24	54	1348	
31	54	30	54	1506	
37	54	36	54	1693	

End Panel for Power Wall

EPAN

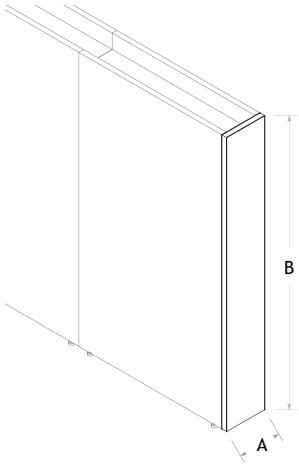

Manufacturing Standards

- End panel:
- 1" laminate panel;
 - With connectors for power wall.

Important: Must be the same height as the power wall

Position of grommet: An ELPF grommet is aligned with the power wall and at 20" H.

To connect division panels on the left or on the right, see products PANL, PANR, PANC.

Options

Grommet



GRC
\$0

How to Order

	AB		GRC NGR (std)
XT		EPAN	
Series	Dimensions	Product	Grommet

Example XT 0842 EPAN N

Prices

Dimensions	
A	B
08 42	94
08 54	100

Walls and Panels

End panel for power wall, extended on one side

EPANL

EPANR

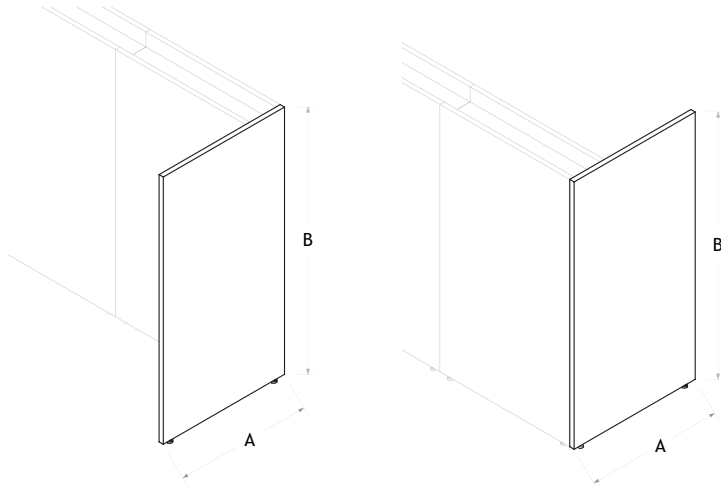

Manufacturing Standards

End panel for power wall, extended on one side:

- 1" laminate panel;
- With connectors for power wall;
- White nylon levelers.

Important: Must be the same height as the power wall.

Connectors: The left panel can only have one connector, on the left. The right panel can only have one connector, on the right.

Position of grommet: An ELPF grommet is aligned with the power wall and at 20" H.

To connect division panels on the left and on the right, see products PANL, PANR, PANC.

Options

Connector

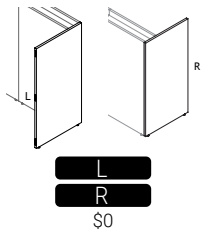

Grommet

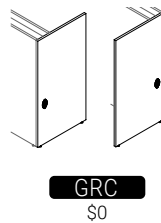

Prices

Dimensions	
A	B
28 42	269
32 42	281
28 54	324
32 54	363

How to Order

XT	AB	EPANL EPANR	L R N (std)	GRC NGR (std)
Series	Dimensions	Product	Connectors	Grommet

Example XT 2842 EPANL N NGR

Walls and Panels

End panel for power wall, extended on both sides

EPANC

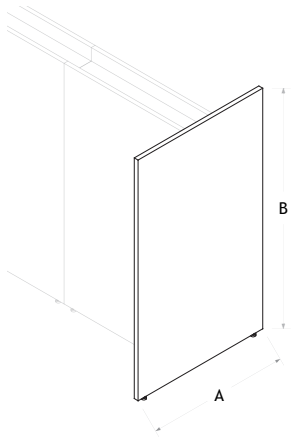

Manufacturing Standards

- End panel for power wall, extended on both sides:
- 1" laminate panel;
 - With connectors for power wall;
 - White nylon levelers.

Important: Must be the same height as the power wall

Position of grommet: An ELPF grommet is aligned with the power wall and at 20" H.

To connect division panels on the left or on the right, see products PANL, PANR, PANC.

Options

Connector

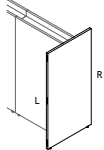

L
R
\$0

Grommet

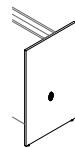

GRC
\$0

Prices

Dimensions	
A	B
32 42	244
48 42	263
32 54	307
48 54	344

How to Order

						+
			L	R	GRC	
			N (std)	N (std)	NGR (std)	
XT	AB	EPANC				
Series	Dimensions	Product	Left connector	Right connector	Grommet	
Example	XT	3242	EPANC	N	N	N

Walls and Panels

Simple panel

PAN

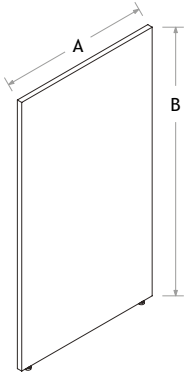

L R

Options

Connector

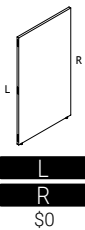

How to Order

Series	Dimensions	Product	N	
			L (std)	R (std)
XT	AB	PAN		
			Left connector	Right connector

Example XT 2642 PAN N N

Manufacturing Standards

Simple panel:

- 1" laminate with connectors on each end;
- White nylon levelers.
- Vertical woodgrain.

Non freestanding furniture.

Refer to [Appendix H](#) for specification rules.

Electrical management: refer to [Appendix G](#).

Panel accessories sold separately.

For wire management, holes must be drilled on site by the installer. See [Accessories](#) section for DSG grommet.

Prices

Dimensions		
A	B	
06	42	83
12	42	96
14	42	110
15	42	115
18	42	137
20	42	158
24	42	185
26	42	200
30	42	234
32	42	250
36	42	287
42	42	319
48	42	363
<hr/>		
06	54	96
12	54	115
14	54	132
15	54	144
18	54	175
20	54	195
24	54	237
26	54	250
30	54	295
32	54	332
36	54	369
42	54	407
48	54	461

Walls and Panels

L-shaped Panel

PANLL

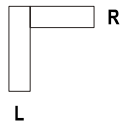
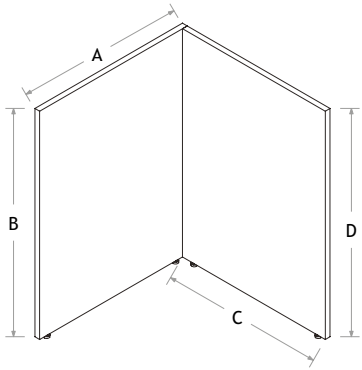

PANLR

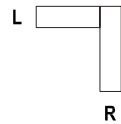
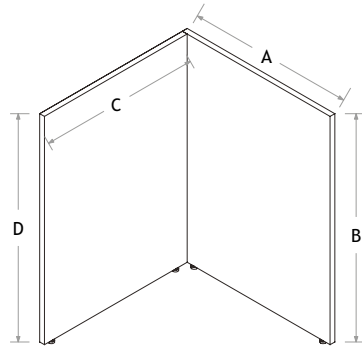

Manufacturing Standards

L-shaped panel:

- Delivered disassembled;
- 1" laminate with connectors on each end;
- White nylon levelers.
- Vertical woodgrain.

Non freestanding furniture.

Refer to [Appendix H](#) for specification rules.

Electrical management: refer to [Appendix G](#).

Panel accessories sold separately.

For wire management, holes must be drilled on site by the installer. See [Accessories](#) section for DSG grommet.

Options

Connector on the left

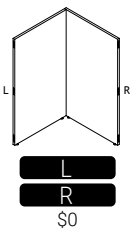

L

R

S0

Prices

Dimensions		
A	B C D	
07 42 06 42		172
21 42 20 42		315
25 42 24 42		370
31 42 30 42		468
37 42 36 42		575
<hr/>		
07 54 06 42		199
21 54 20 42		350
25 54 24 42		423
31 54 30 42		526
37 54 36 42		655
<hr/>		
07 54 06 54		217
21 54 20 54		387
25 54 24 54		475
31 54 30 54		587
37 54 36 54		736

How to Order

XT	AB	PANLR PANLL	CD	N L (std)	N R (std)
Series	Dimensions 1st panel	Product	Dimensions 2nd panel	Left connector	Right connector
Example XT	2142	PANLR	2042	N	N

Walls and Panels

T-Shaped Panel

PANT

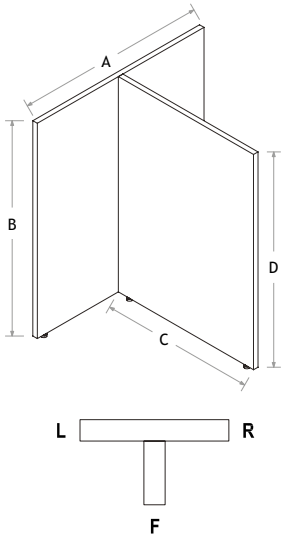

Manufacturing Standards

T-shaped panel:

- Delivered disassembled;
- 1" laminate with the possibility to connect on each end;
- White nylon levelers.
- Vertical woodgrain.

Non freestanding furniture.

Refer to [Appendix H](#) for specification rules.

Electrical management: refer to [Appendix G](#).

Panel accessories sold separately.

For wire management, holes must be drilled on site by the installer. See [Accessories](#) section for DSG grommet.

Options

Connector

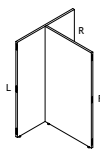

L \$0 F \$0 R \$0

Prices

Dimensions

A B C D

13 42 06 42 172

13 42 12 42 185

21 42 20 42 319

25 42 24 42 363

31 42 30 42 468

37 42 36 42 575

41 42 40 42 637

13 54 06 42 199

13 54 12 42 218

21 54 20 42 370

25 54 24 42 410

31 54 30 42 526

37 54 36 42 655

41 54 40 42 725

13 54 06 54 217

13 54 12 54 237

21 54 20 54 407

25 54 24 54 461

31 54 30 54 587

37 54 36 54 736

41 54 40 54 813

How to Order

XT	AB	PANT	CD	N L (std)	N R (std)	N F (std)	
Series	Dimensions	Product	Height	Left connector	Right connector	Front connector	
Example	XT	1342	PANT	1242	N	N	N

Walls and Panels

X-shaped Panel

PANX

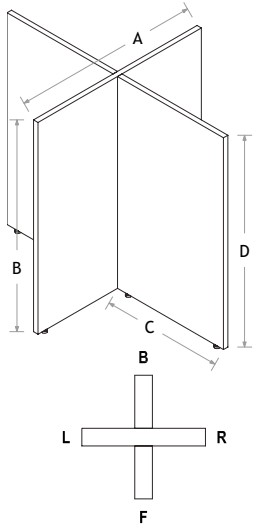

Manufacturing Standards

X-shaped panel:

- Delivered disassembled;
- 1" with the possibility to connect on each end;
- White nylon levelers;
- Vertical woodgrain.

Non freestanding furniture.

Refer to [Appendix H](#) for specification rules.

Electrical management: refer to [Appendix G](#).

Panel accessories sold separately.

For wire management, holes must be drilled on site by the installer. See [Accessories](#) section for DSG grommet.

Options

Connector on the left

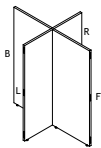

- L** \$0
- F** \$0
- R** \$0
- B** \$0

How to Order

Series	Dimensions	Product	Height 2nd panel	N L (std)	N R (std)	N F (std)	N B (std)
XT	AB	PANX	CD	Left connector	Right connector	Front connector	Rear connector
Example XT	1342	PANX	1242	N	N	N	N

Prices

Dimensions	A	B	C	D	Price
13 42 06 42	13	42	06	42	268
13 42 12 42	13	42	12	42	287
21 42 20 42	21	42	20	42	476
25 42 24 42	25	42	24	42	547
31 42 30 42	31	42	30	42	700
37 42 36 42	37	42	36	42	862
41 42 40 42	41	42	40	42	956
<hr/>					
13 54 06 42	13	54	06	42	311
13 54 12 42	13	54	12	42	331
21 54 20 42	21	54	20	42	509
25 54 24 42	25	54	24	42	608
31 54 30 42	31	54	30	42	761
37 54 36 42	37	54	36	42	943
41 54 40 42	41	54	40	42	1043
<hr/>					
13 54 06 54	13	54	06	54	349
13 54 12 54	13	54	12	54	369
21 54 20 54	21	54	20	54	582
25 54 24 54	25	54	24	54	712
31 54 30 54	31	54	30	54	882
37 54 36 54	37	54	36	54	1106
41 54 40 54	41	54	40	54	1218

Panel Accessories

Hanging tackboard

TBP

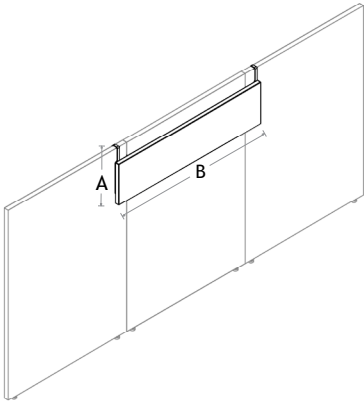

Manufacturing Standards

Hanging tackboard :

- 7/8" tackboard, 1/8" tick clip, ~1" thick total;
- Hanging on panels or on power walls;
- 2 hooks in the finish of your choice included.

The height of the panels is 3" less than the overall height.

We do not recommend the use of tackboards with height adjustable tables unless there is adequate clearance.

COM Fabrics: COM Fabrics are provided by the customer. For pricing please refer GR2 grade price

Prices

Dimensions		GRA	GR1	GR2	GR3	GR4	GR5	GR6	GR7	GR8	GR9	GR10	GR11	GR12
A	B													
12	24	289	317	352	388	433	478	522	567	611	656	700	790	880
12	30	289	317	352	388	433	478	522	567	611	656	700	790	880
12	36	289	317	352	388	433	478	522	567	611	656	700	790	880
12	42	289	317	352	388	433	478	522	567	611	656	700	790	880
12	48	289	317	352	388	433	478	522	567	611	656	700	790	880
12	54	289	317	352	388	433	478	522	567	611	656	700	790	880
12	60	391	427	475	522	582	642	700	760	820	880	938	1058	1176
12	66	391	427	475	522	582	642	700	760	820	880	938	1058	1176
12	72	439	483	543	603	677	752	825	900	974	1050	1123	1272	1420
18	24	318	345	381	416	460	506	550	595	640	685	729	818	907
18	30	318	345	381	416	460	506	550	595	640	685	729	818	907
18	36	318	345	381	416	460	506	550	595	640	685	729	818	907
18	42	318	345	381	416	460	506	550	595	640	685	729	818	907
18	48	318	345	381	416	460	506	550	595	640	685	729	818	907
18	54	318	345	381	416	460	506	550	595	640	685	729	818	907
18	60	420	456	504	552	611	671	730	790	849	908	968	1087	1206
18	66	420	456	504	552	611	671	730	790	849	908	968	1087	1206
18	72	468	512	571	630	706	780	853	928	1002	1077	1151	1300	1448
24	24	345	372	408	444	488	534	578	622	666	712	756	845	934
24	30	345	372	408	444	488	534	578	622	666	712	756	845	934
24	36	345	372	408	444	488	534	578	622	666	712	756	845	934
24	42	345	372	408	444	488	534	578	622	666	712	756	845	934
24	48	345	372	408	444	488	534	578	622	666	712	756	845	934

How to Order

Series	Dimensions	Product	Metal finish
XT	AB	TBP	SN WH BL (std)

Example XT 1824 TBP BL

Markerboard

MBP

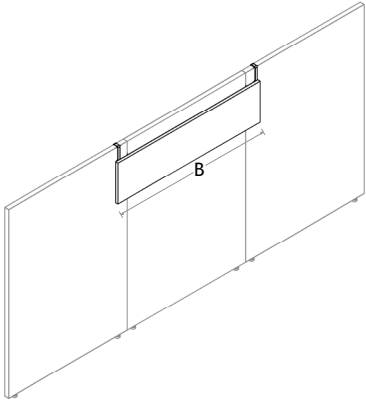

Manufacturing Standards

Markerboard:

- 5/8" board, 1/8" tick clip, ~3/4" thick total;
- To install on panels or on power walls;
- 2 hooks in the finish of your choice included.

The height of the tackboard is 3" less than the overall height.

We do not recommend the use of tackboards with height adjustable tables unless there is adequate clearance.

Prices

Dimensions

A	B	C
12	24	126
12	30	137
12	36	150
12	42	163
12	48	175
12	54	187
12	60	200
12	66	212
12	72	225

18	24	157
18	30	175
18	36	195
18	42	212
18	48	232
18	54	250
18	60	269
18	66	287
18	72	307

24	24	181
24	30	207
24	36	232
24	42	256
24	48	281

How to Order

Series	Dimensions	Product	Metal finish
XT	AB	MBP	SN WH BL (std)

Example

XT	1824	MBP	BL
----	------	-----	----

Panel Accessories



Transaction Shelf

SHP

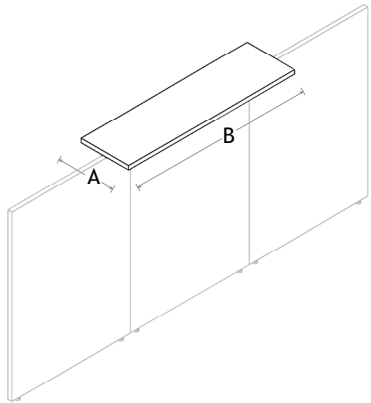

Manufacturing Standards

- Transaction shelf with:
- 1" laminate;
 - 2 "L" brackets included;
 - To install on dividing panels or power walls;
 - 2 brackets when less than 42", 3 brackets when 42" and more.

Prices

Dimensions		
A	B	C
12 24		107
12 30		112
12 36		119
12 42		126
12 48		132
12 54		144
12 60		157
12 66		169
12 72		181

How to Order

AB		
XT		SHP
Series	Dimensions	Product

Example **XT** 1224 **SHP**

Panel Accessories

Metal Planter Box

LPLANTS

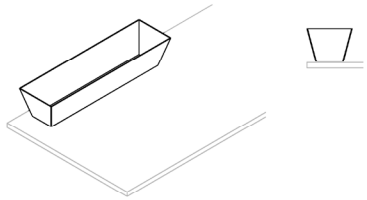

LPLANTP

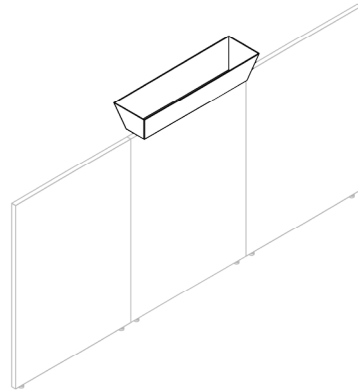

Dividing panel



Power wall

Manufacturing Standards

Metal Planter Box:

- Dimensions: 8 x 30 x 6 H
- LPLANTS: Set-on surface
- LPLANTP: Rests on dividing panel

Prices

Code	
LPLANTS	445
LPLANTP	470

How to Order

LPLANTS	SN
LPLANTP	WH
	BL (std)
<input type="text"/>	<input type="text"/>
Product	Metal finish

Example LPLANTP BL

Panel Accessories



Acrylic divider on panel

EAS

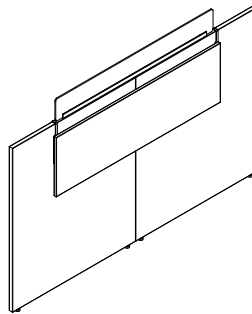
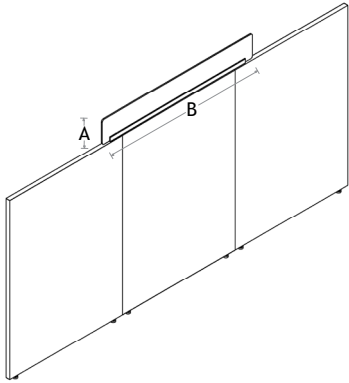

EAS screens compatible with	Length of XT TBP/MBP
0622EAS	24
0628EAS	30
0634EAS	36
0640EAS	42
0646EAS	48
0652EAS	54
0658EAS	60
0664EAS	66
0670EAS	72

Manufacturing Standards

Acrylic divider on panel:

- Acrylic panel with metal finish of your choice extrusion;
- Fixed on edge.

Dimension "B" allows the installation of panel accessories in combination with the divider.

Metal extrusion is 4" shorter than acrylic panel

Metal finishes available in satin nickel (SN), white (WH) and black (BL).

Prices

Dimensions	
A	B
06 22	181
06 28	212
06 34	244
06 40	269
06 46	295
06 52	312
06 58	319
06 64	324
06 70	332

How to Order

XT	AB	EAS	SN WH BL (std)
Series	Dimensions	Product	Metal finish

Example XT 0622 EAS BL

Panel Accessories



Glass divider on panel

EGS

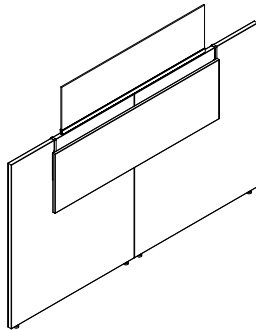
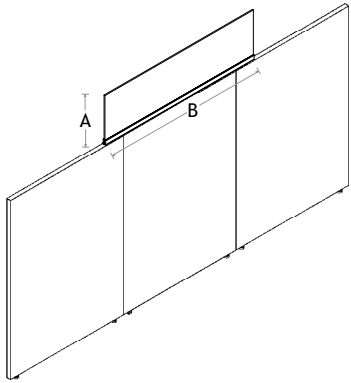

EGS screens compatible with	Length of XT TBP/MBP
1221EGS	24
1224EGS	30
1230EGS	36
1236EGS	42
1242EGS	48
1248EGS	54
1254EGS	60
1260EGS	66
1266EGS	72
1272EGS	--

Manufacturing Standards

- Glass divider on panel:
- 1/4" frosted tempered glass screen, frosted glass on 1 side;
 - Metal extrusion of the finish of your choice;
 - Hardware included;
 - Fixed on edge.

The dividers are 1/4" smaller than the code's B dimension.
Ex.: XT 1236EGS has a length of 35 3/4".

Metal finishes available in satin nickel (SN), white (WH) and black (BL).

Prices

Dimensions	
A	B
12 21	199
12 24	204
12 30	242
12 36	269
12 42	305
12 48	336
12 54	394
12 60	426
12 66	446
12 72	453

How to Order

XT	AB	EGS	SN WH BL (std)
Series	Dimensions	Product	Metal finish

Example XT 1221 EGS BL

Panel Accessories



Hexagonal felt tile

ATF01

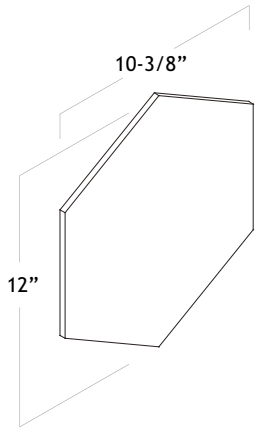

Manufacturing Standards

Hexagonal felt tile:

- Accoustical adhesive felt tile 10-3/8" x 12" x 1/4".
- Sound absorption characteristics:
NRC: 0.23
SAA: 0.23
ASTM: C423

Important: Item is too thin to be used as tackboard.

Felt colors: Blue **BL**, Light Grey **LG**, Dark Grey **DG**.

Prices

Code	
ATF01 LG	66
ATF01 DG	66
ATF01 BL	66

How to Order

ATF01	BL LG DG
Product	Felt color

Example ATF01 BL

Stabilizing Laminate Corner

MTC

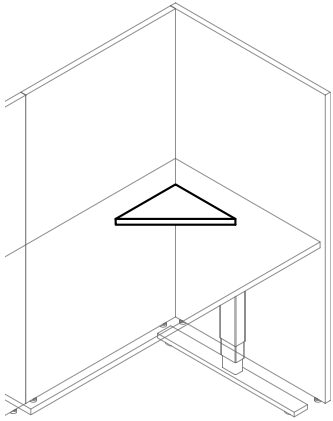

Manufacturing Standards

Stabilizing laminate corner with:

- 1" laminate panel;
- Mounting hardware;
- Made for situations where no items are panel mounted;
- Maximum load: 25lbs.

Prices

Dimensions

A	B
12	61

How to Order

Series	Dimensions	Product
XT	12 12	MTC

Example XT 1212 MTC



Sound absorbing overhead screen - 1-sided

OHSS

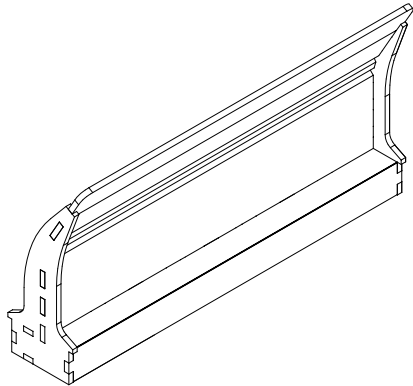

Manufacturing Standards

- Sound absorbing overhead screen - 1 sided:
- Total height of 18", exceeds 15" from the wall;
 - 100% PET (min, 50% recycled content);
 - 12 mm material;
 - 15 finishes available;
 - No hardware assembly;
 - Fully tackable surface;
 - Sound absorption characteristics:
NRC: 0.80
SAA: 0.80
ASTM C423

Ezobord Colors: Bold Gray **BG07**, Green Moss **MG10**.
For more colors, see [Appendix A](#). Note that you must order 6 or more to access the other colors.

Prices

Dimensions	
A	
30	1031
36	1031

How to Order

OHSS		
Product	Dimensions	Finishes see appendix A

Example OHSS 30 BG07



Sound absorbing overhead screen - 2-sided

OHSD

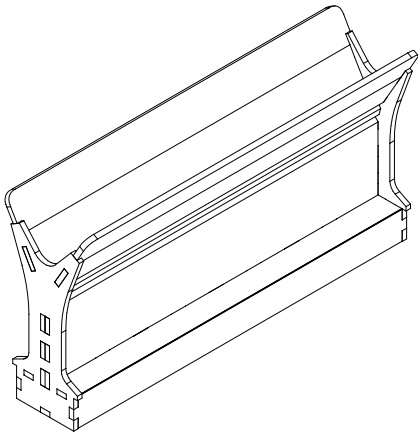

Manufacturing Standards

- Sound absorbing overhead screen - 2 sided:
- Total height of 18", exceeds 15" from the wall;
 - 100% PET (min, 50% recycled content);
 - 12 mm material;
 - 15 finishes available;
 - No hardware assembly;
 - Fully tackable surface;
 - Sound absorption characteristics:
NRC: 0.80
SAA: 0.80
ASTM C423

Ezobord Colors: Bold Gray **BG07**, Green Moss **MG10**.
For more colors, see [Appendix A](#). Note that you must order 6 or more to access the other colors.

Prices

Dimensions	
A	
30	1218
36	1218

How to Order

OHSD		
Product	Dimensions	Finishes see appendix A

Example OHSD 30 BG07

Panel Accessories

Laminate Cover

CTCOVER

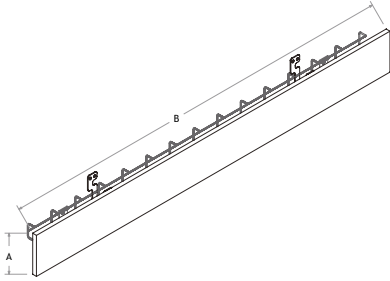

Manufacturing Standards

Laminate cover:

- Laminate cover for cable tray;
- Mounting brackets;
- Dimension "B" is 1/4" recessed.

Prices

Dimensions	
A	B
06 30	58
06 36	63
06 42	69
06 48	74
06 54	82
06 60	88
06 66	94
06 72	100
06 78	107
06 84	112

How to Order

	AB	CTCOVER
XT		
Series	Dimensions	

Example XT 0630 CTCOVER

Surfaces

Rectangular surface 15" & 20"D

TOP

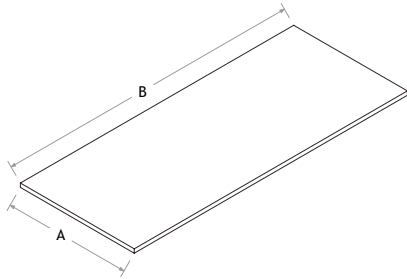

Options

1½" space for wiring

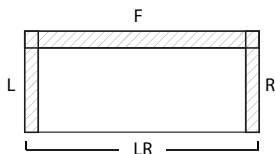

SP_ \$0

How to Order

XT	AB	TOP	SP3 SPL SPLR SPR SPFR SPF SPFL SPN (std)
Series	Dimensions	Product	Space 1½" for wiring

Example XT 1524 TOP SPN

Manufacturing Standards

Rectangular surface:

- 1" laminate surface;
- Hardware sold separately;
- Wiring space is removed from the overall dimension.

No machining.

Support: Legs, cantilever and independent storage are sold separately.

Maximum distance between two supports: 42".

Stiffener: The use of stiffeners is necessary for surfaces of 54" and more. It is used for the part of the surface not supported by a pedestal.

Prices

Dimensions	
A	B
15 24	107
15 30	107
15 36	107
15 42	110
15 48	126
15 54	141
15 60	157
15 66	173
15 72	187
15 78	203
15 84	219
<hr/>	
20 16	107
20 24	107
20 30	108
20 36	126
20 42	146
20 48	166
20 54	187
20 60	209
20 66	229
20 72	250
20 78	272
20 84	290

Surfaces

Rectangular surface 24", 30" & 36"D (following)

TOP

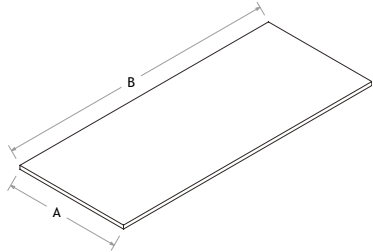

Options

1½" space for wiring

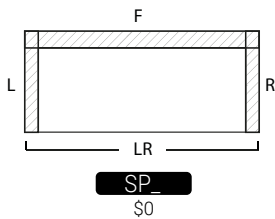

How to Order

XT	AB	TOP	SP3 SPL SPLR SPR SPFR SPF SPFL SPN (std)
Series	Dimensions	Product	Space 1½" for wiring

Example XT 2430 TOP SPN

Manufacturing Standards

- Rectangular surface:
- 1" laminate surface;
 - Hardware sold separately;
 - Wiring space is removed from the overall dimension.

No machining.

Support: Legs, cantilever and independent storage are sold separately.

Maximum distance between two supports: 42".

Stiffener: The use of stiffeners is necessary for surfaces of 54" and more. It is used for the part of the surface not supported by a pedestal.

Prices

Dimensions		
A	B	
24	30	126
24	36	150
24	42	175
24	48	200
24	54	225
24	60	250
24	66	275
24	72	300
24	78	324
24	84	349
<hr/>		
30	54	281
30	60	312
30	66	344
30	72	375
30	78	407
30	84	437
<hr/>		
36	54	354
36	60	393
36	66	434
36	72	473
36	78	513
36	84	550

Surfaces



D surface

DTOP

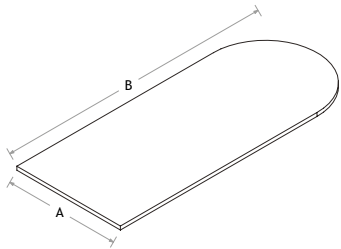

Manufacturing Standards

- D surface:
- 1" laminate;
 - Hardware sold separately: See the support and modesty section. An independent pedestal can also be used;
 - Wiring space is removed from the overall dimension.

No machining.

Support: Legs, cantilever and independent storage are sold separately.

Maximum distance between two supports: 42".

Stiffener: The use of stiffeners is necessary for surfaces of 54" and more. It is used for the part of the surface not supported by a pedestal.

Options

1½" space for wiring

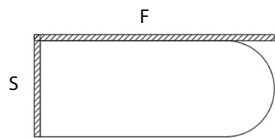

SP_ \$0

Prices

Dimensions	
A	B
24	54
24	60
24	66
24	72
24	78
24	84
30	54
30	60
30	66
30	72
30	78
30	84
36	54
36	60
36	66
36	72
36	78
36	84

How to Order

XT	AB	DTOP	SPF SPS SPFS SPN (std)
Series	Dimensions	Product	Space 1½" for wiring

Example XT 2454 DTOP SPN

Surfaces

Collaboration surface

COLTOP

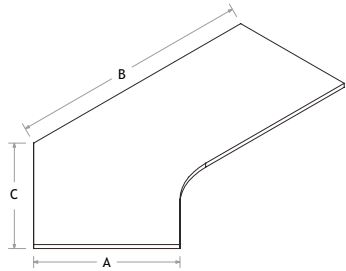

CORTOP

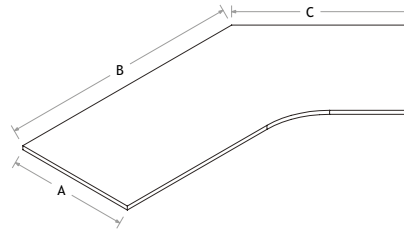

Manufacturing Standards

Collaboration surface:

- 1" laminate;
- Angle: 135
- Hardware sold separately;
- Wiring space is removed from the overall dimension.

Overall dimensions :

- 30 54 30 : 43"D x 75-3/4"W
- 30 60 36 : 47-1/4"D x 86"W
- 30 66 36 : 47-1/4"D x 92"W

No machining.

Support: Legs, cantilever and independent storage are sold separately.

Maximum distance between two supports: 42".

Stiffener: The use of stiffeners is necessary for surfaces of 54" and more. It is used for the part of the surface not supported by a pedestal.

Options

1½" space for wiring

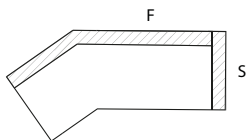

SP_ \$0

Prices

Dimensions

A	B	C	
30	54	30	709
30	60	36	895
30	66	36	957

How to Order

XT	ABC	COLTOP CORTOP	SPF SPS SPFS SPN (std)
Series	Dimensions	Product	Space 1½" for wiring

Example XT 305430 COLTOP SPN



Privacy corner screen

FSFD

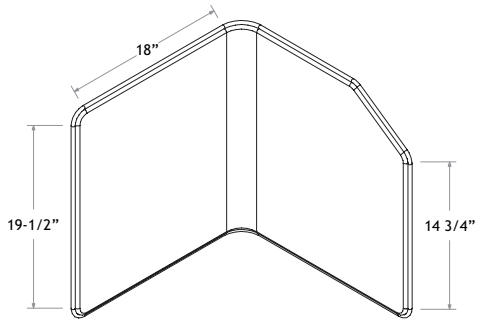

Manufacturing Standards

- Privacy Corner Screen
- 7/8" thick plywood panel, upholstered;
 - With decorative piping;
 - Set-on surface;
 - Panel / tackboard fabrics not recommended;
 - Dimensions: 18" x 19-1/2".

Cannot be used as a tackboard

COM Fabrics: COM Fabrics are provided by the customer. For pricing please refer GR2 grade price

Prices

	GRA	GR1	GR2	GR3	GR4	GR5	GR6	GR7	GR8	GR9	GR10	GR11	GR12
FSFD	464	491	526	562	607	652	696	741	785	830	874	964	1054

How to Order

FSFD

Product Fabrics
see appendix A

Example FSFD TBFRME

Supports

End leg

ENDLEG

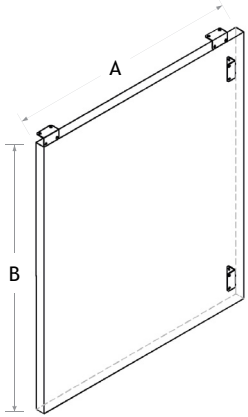

Manufacturing Standards

- End Leg:
- 1" Laminate;
 - 4 mounting brackets;
 - White nylon levelers;
 - Height: 28"H.

Prices

Dimensions		
A	B	
20	28	137
24	28	150
30	28	163
36	28	175

How to Order

	AB		
	XT		ENDLEG
Series	Dimensions		Product

Example XT 2028 ENDLEG

Supports

Middle leg

MIDLEG

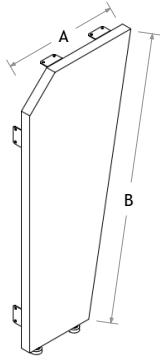

Manufacturing Standards

- Middle leg:
- 1" laminate with space for wiring;
 - 4 mounting brackets;
 - White nylon levelers;
 - Height: 28"H.

Prices

Dimensions

A	B
1228	172

How to Order

	AB	
Series	Dimensions	Product
XT		MIDLEG

Example XT 1228 MIDLEG

Supports

Legs

RAW

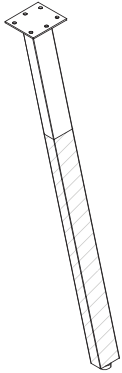

RA2

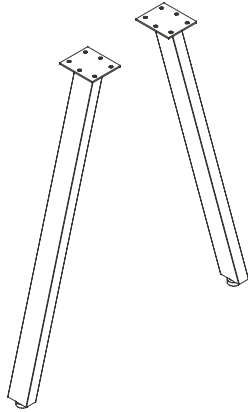

HATLEY



Manufacturing Standards

RAW:

- Base in metal, finish: Satin Nickel (SN), White (WH) and Black (BL);
- Wood insert (18");
- White nylon levelers;
- Height: 28".

RA2:

- Set of 2 angled rectangular metal legs;
- Dimensions: 2" x 1";
- Finish: Satin Nickel (SN) and Black (BL);
- Height: 28".

HATLEY:

- Set of two 28" tapered legs with wood insert;
- 4" x 4" end plate;
- Finish: Satin Nickel (SN), Chrome (CHR) and Black (BL);
- Height: 28".

For stability reasons, please check with your account manager the dimensions of your furniture when ordering this leg separately from the surface.

Available colors for wood (RAW & HATLEY): White Wash WW, Golden Wheat GW, Sand SD, Apricot AT, Pecan PN, Brandy BR, Chestnut CT, Coffee CF, Espresso ES, Bordeaux BO, Black Wash BW and Bark BK

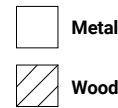

Prices

Code	
RAWBL	196
RAWSN	196
RAWWH	196
Code	
RA2SN	197
RA2BL	197
RA2WH	197
Code	
HATSN	327
HATCHR	327
HATBL	327

How to Order

RAW			RA2			HAT		
Product	Metal	wood color	Product	Metal	wood color	Product	Metal	wood color
RAW	WH SN BL (std)	Finishes See the Logiflex Color Guide	RA2	WH SN BL		HAT	CHR SN BL	Finishes See the Logiflex Color Guide
Example	RAW	BL	Example	RA2	BL	Example	HAT	BL
		GW						GW

Supports

Legs

4.5

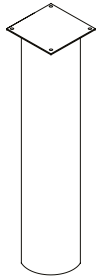

IFN

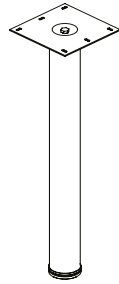

Manufacturing Standards

- 4.5:
- Fixed round metal leg / on leveler;
 - 4-1/2" diameter;
 - 6" x 6" end plate;
 - Finish: Black (BL) and Satin Nickel (SN);
 - Height: 27-1/2".

- IFN:
- Fixed round metal leg / on leveler;
 - 2-1/2" diameter;
 - 3-3/4" x 3-3/4" end plate screwed to the leg;
 - Finish: Black (BL) and Satin Nickel (SN);
 - Height: 27-1/2".

Prices

Code	
4.5BL	252
4.5SN	252

Code	
IFNBL	88
IFNSN	88

How to Order

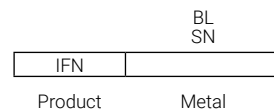
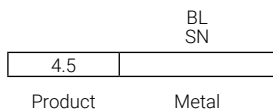

Example 4.5 BL

Example IFN BL

Supports

Legs

LENNOX

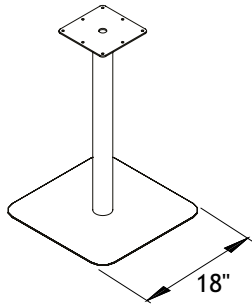

MAGOG

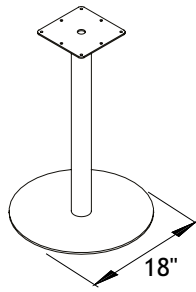

Manufacturing Standards

LENNOX:

- Fixed Lennox leg;
- Base: 18";
- 8" x 8" end plate;
- Finish: Satin Nickel (SN), Black (BL) and Chrome (CHR);
- Height: 28".

MAGOG:

- Fixed Magog leg;
- Base: 18";
- 8" x 8" end plate;
- Finish: Satin Nickel (SN), Black (BL) and Chrome (CHR);
- Height: 28".

For stability reasons, please check with your account manager the dimensions of your furniture when ordering this leg separately from the surface.

Prices

Code	
LENSN	520
LENBL	520
LENCHR	1061
LENWH	520

Code	
MAGSN	520
MAGBL	520
MAGCHR	1061
MAGWH	520

How to Order

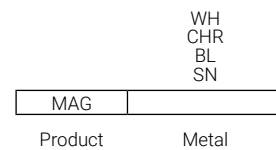
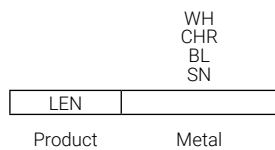

Example LEN BL

Example MAG BL

Supports

Legs

PATTEC30

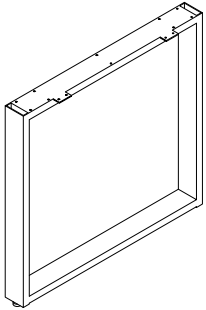

PATTEC36

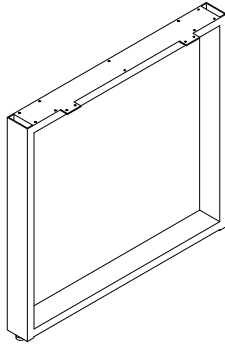

Manufacturing Standards

C Metal Leg:

- Base in metal, Black (BL);
- White nylon levelers;
- Height: 28"H;
- 1 ½" space for wiring with top is not compatible.

Prices

Code	
PATTEC30	342
PATTEC36	387

How to Order

PATTEC30	WH
PATTEC36	SN
	BL (std)
<input type="text"/>	<input type="text"/>
Product	Metal

Example PATTEC30 BL

Supports

Layering Desk Supports

DRSUP

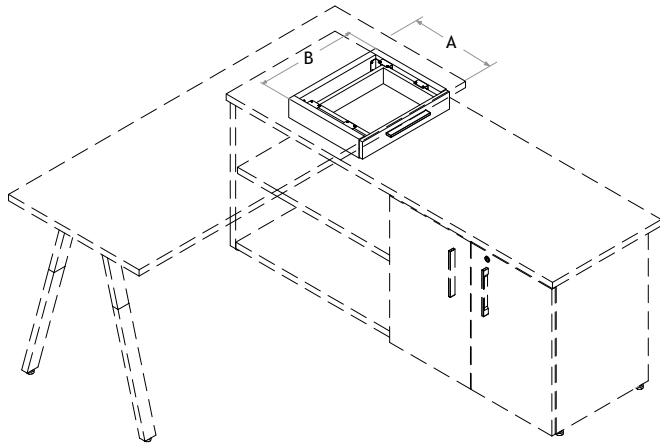

Manufacturing Standards

Layering desk:

- Drawer and front 5/8" laminate;
- Frame 1" laminate;
- Mounting brackets, screws and double-sided tape included;
- Height: 3"H.
- Interior dimensions of the drawer: 11-11/16" width x 9-3/8" depth x 2-1/2" height.
- Dimensions recommendations:
 - A 14 B 16 for 24" surface
 - A 20 B 16 for 30" surface
 - A 26 B 16 for 36" surface

Support for high cabinets: This product is used to support the surface on a high cabinet 25"H.

Color Combination

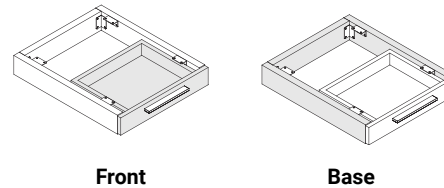

Prices

Dimensions	
A	B
14 16	221
20 16	221
26 16	221

How to Order

	AB	H071BL (std)	
Series	Dimensions	Product	Handle
Example	XT	1416	DRSUP H071BL

Supports

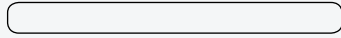

T-Support

TSUP

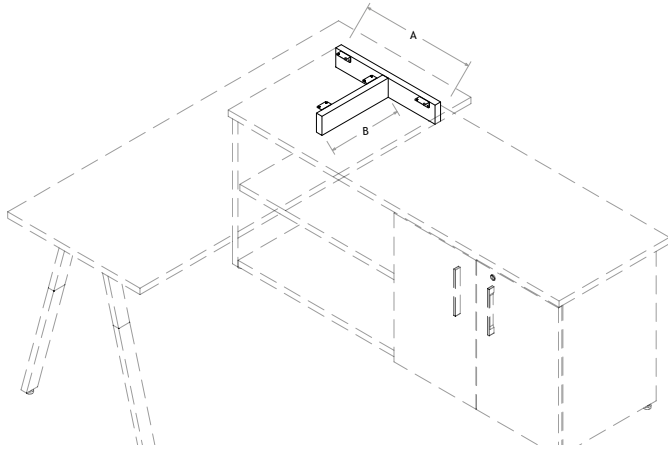

Manufacturing Standards

T-Support:

- 1" laminate;
- Mounting brackets, screws and double-sided tape included;
- Height: 3"H;
- Dimensions recommendations:
 - A 18 B 12 for 24" surface
 - A 26 B 12 for 30" surface
 - A 32 B 12 for 36" surface

Support for high cabinets: This product is used to support the surface on a high cabinet 25"H.

Prices

Dimensions	
A	B
18 12	107
26 12	107
32 12	107

How to Order

AB		
XT		TSUP
Series	Dimensions	Product

Example XT 1812 TSUP

Supports

Cantilever support with space for cable tray

CNT01

CNT02

CNT03

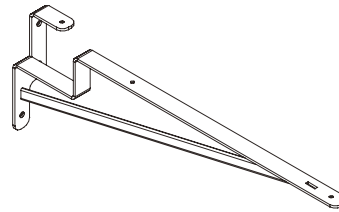
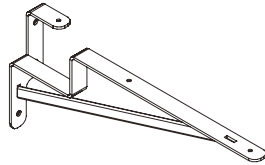
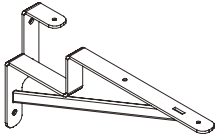

Manufacturing Standards

Cantilever support with space for cable tray:

- Metal support, Satin Nickel finish;
- Without pointing for assembly;
- Height: 8"H.

Dimensions :

CNT01 : 16.5", for 20"D surface

CNT02 : 20.5", for 24"D and 30"D surface

CNT03 : 27", for 36"D surface

To help installation, order IGS.

Work surface support.

Refer to [Appendix H](#) for specification rules.

Compatible with CT24 and CT118 cable tray.

Prices

Code

CNT01	61
CNT02	66
CNT03	73

How to Order

CNT01
CNT02
CNT03

	SN
--	----

Product Metal

Example CNT01 SN

Supports

Slender cantilever support

CNTC01

CNTC02

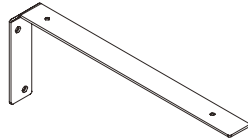
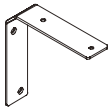

Manufacturing Standards

Cantilever support without reinforcement bar:

- Metal support;
- Without pointing for assembly;
- Height: 6"H.

Dimensions :

CNTC01 : 6", for surfaces less than 30"

CNTC02 : 16", for surfaces 30" and more

*Work surface support.
Refer to [Appendix H](#) for specification rules.*

To be used at the end of a surface when there is no electrical management.

Prices

Code	
CNTC01	27
CNTC02	37

How to Order

CNTC01	WH
CNTC02	BL
	SN (std)
<input type="text"/>	<input type="text"/>
Product	Metal

Example CNTC01 SN

Supports

Shelf Support

CNTSH

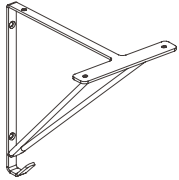

Manufacturing Standards

Shelf Support:

- Metal, finishes: Satin Nickel (SN), Black (BL) or White (WH);
- with hook at the base of the support;
- without pointing for assembly;
- For surface with a depth of 15";
- Support dimensions: 9"x9";
- Maximum capacity of 25kg per support.

Prices

Code	
CNTSH SN	82
CNTSH BL	82
CNTSH WH	82

How to Order

CNTSH	WH BL SN
Product	Metal

Example CNTSH SN

Supports

Stiffener

RSTF

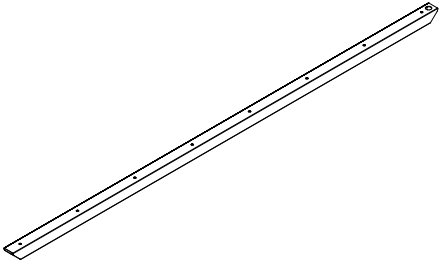

Manufacturing Standards

Stiffener:

- Metal, Satin Nickel finish;
- Suggested for work surfaces 54" or more;
- Installation hardware included.

Prices

Dimensions	
A	
40	101
46	101
52	101
58	101
64	101
70	101

How to Order

	A
RSTF	

Product Dimensions

Example RSTF 40

Supports

Flush Plates

FP2BL

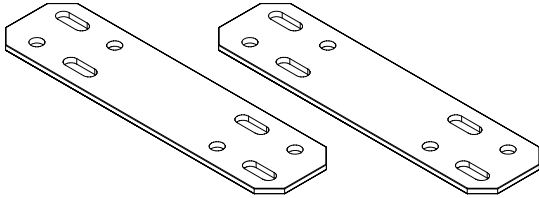

Manufacturing Standards

- 2 Flush Plates with Screws:
- Metal support, Black finish;
 - Without pointing for assembly.

Work surface support.

Refer to [Appendix H](#) for specification rules.

Prices

Code

FP2BL

16

How to Order

FP2BL

Product

Example FP2BL

Independant Pedestals

Independant E pedestal

EIND

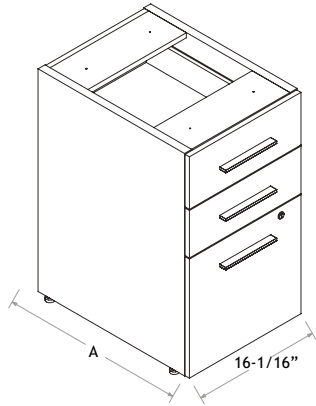

Color Combinaison

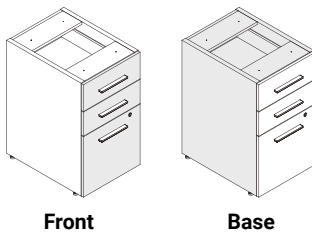

Depth of Leg

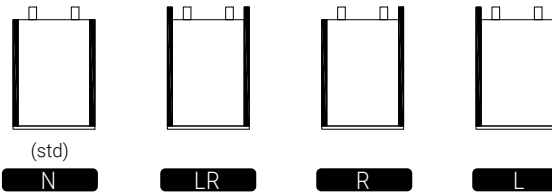

Manufacturing Standards

- Independant pedestal with 2 utility drawers and file drawer:
- Pedestal without top;
 - 2-3/8" back and sides recess for wire management;
 - Fix to the panel using L bracket. The positioning brackets on the back allow you to leave a 2-3/8" wiring space and to attach the pedestal to the division panels or to the low walls.
 - 14-3/32"H opening in the back;
 - White nylon levelers;
 - Handles H071BL;
 - Lock;
 - Height: 28"H.
- Attention: This pedestal is designed for use under a work surface or a return. A fitted surface - 16" wide - is not possible due to the width of the pedestal (16 1/16").

To use with power walls and division panels.

Remove lock as option, no extra charge.

Specify if different handle desired (no extra charge, [see p. 98](#)).

Prices

Dimensions	
A	
20	1008
24	1021
30	1034

How to Order

XT	EIND	A	R L LR N (std)	H071BL (std)	N LKSN LKBL (std)
Series	Product	Depth	Full depth placket	Handle	Lock
Example XT	EIND	20	N	H071BL	LKBL

Independant Pedestals

Independant F pedestal

FIND

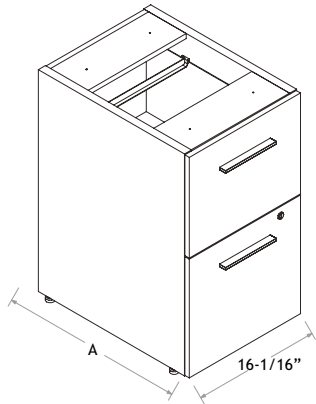

Color Combinaison

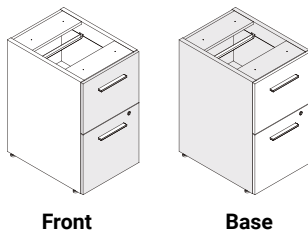

Depth of Leg

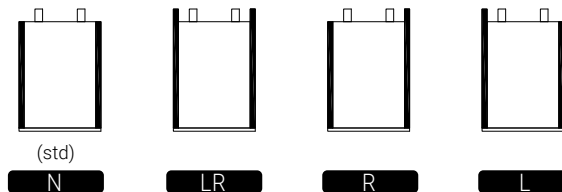

Manufacturing Standards

Independant pedestal with 2 file drawers:

- Pedestal without top;
- 2-1/2" back and sides recess for wire management;
- Fix to the panel using L bracket. The positioning brackets on the back allow you to leave a 2-3/8" wiring space and to attach the pedestal to the division panels or to the low walls.
- 14-3/32"H opening in the back;
- White nylon levelers;
- Handles H071BL;
- Lock;
- Height: 28"H.
- Attention: This pedestal is designed for use under a work surface or a return. A fitted surface - 16" wide - is not possible due to the width of the pedestal (16 1/16").

To use with power walls and division panels.

Remove lock as option, no extra charge.

Specify if different handle desired (no extra charge, [see p. 98](#)).

Prices

Dimensions	
A	
20	991
24	1002
30	1016

How to Order

XT	FIND	A	R L LR N (std)	H071BL (std)	N LKSN LKBL (std)	
Series	Product	Depth	Full depth placket	Handle	Lock	
Example	XT	FIND	20	N	H071BL	LKBL

Independant Pedestals

Independant pedestal with 1 pigeonhole, 1 utility drawer Pedestal without top

PGDIND

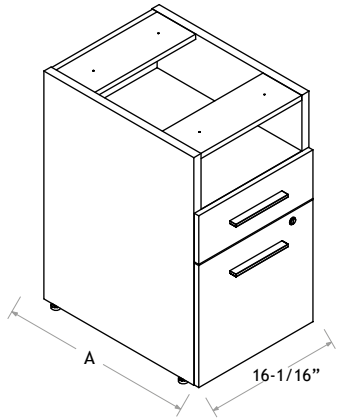

Color Combainson

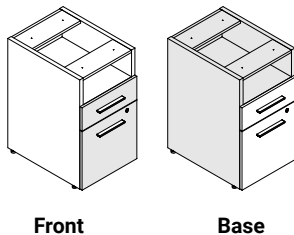

Depth of Leg

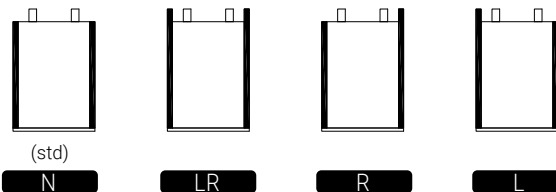

Manufacturing Standards

- Independant pedestal with 1 pigeonhole, 1 utility drawer Pedestal without top;
- Pedestal without top;
 - Pigeonhole height: 6-1/8;
 - 2-1/2" back and sides recess for wire management;
 - Fix to the panel using L bracket. The positioning brackets on the back allow you to leave a 2-3/8" wiring space and to attach the pedestal to the division panels or to the low walls.
 - 14-3/32"H opening in the back;
 - White nylon levelers;
 - Handles H071BL;
 - Lock;
 - Height: 28"H.
- Attention: This pedestal is designed for use under a work surface or a return. A fitted surface - 16" wide - is not possible due to the width of the pedestal (16 1/16").

To use with power walls and division panels.

Remove lock as option, no extra charge.

Specify if different handle desired (no extra charge, [see p. 98](#)).

Prices

Dimensions	
A	
20	1008
24	1021
30	1034

How to Order

Series	Product	Depth	Full depth packet	Handle	Lock
Example	XT	PGDIND	20	N	LKBL

Independant Pedestals

Independant cabinet with 1 utility drawer and 1 open space

UOIND

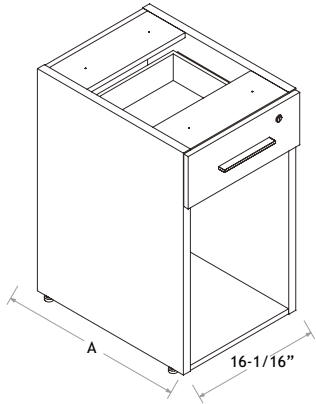

Color Combainson

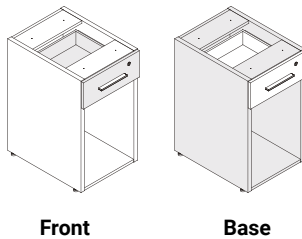

Depth of Leg

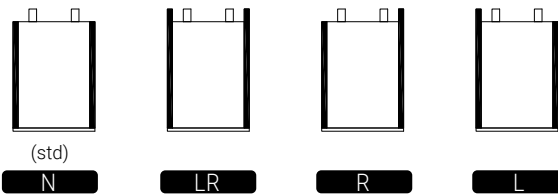

Manufacturing Standards

- Independant cabinet with 1 utility drawer and 1 open space:
- Pedestal without top;
 - Height of open space: 19-3/4"H;
 - 2-1/2" back and sides recess for wire management;
 - Fix to the panel using L bracket. The positioning brackets on the back allow you to leave a 2-3/8" wiring space and to attach the pedestal to the division panels or to the low walls.
 - 14-3/32"H opening in the back, concealed with a removable panel;
 - White nylon levelers;
 - Handles H071BL;
 - Lock;
 - Height: 28"H.
- Attention: This pedestal is designed for use under a work surface or a return. A fitted surface - 16" wide - is not possible due to the width of the pedestal (16 1/16").

To use with power walls and division panels.

Remove lock as option, no extra charge.

Specify if different handle desired (no extra charge, [see p. 98](#)).

Prices

Dimensions	
A	
20	794
24	857
30	918

How to Order

XT	UOIND	A	R L LR N (std)	H071BL (std)	N LKSN LKBL (std)
Series	Product	Depth	Full depth placket	Handle	Lock
Example XT	UOIND	20	N	H071BL	LKBL

Independant Pedestals

Independant cabinet with 1 door

ARLIND

ARRIND

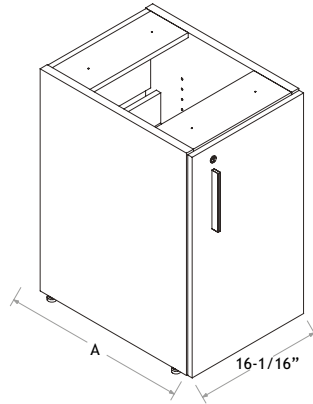
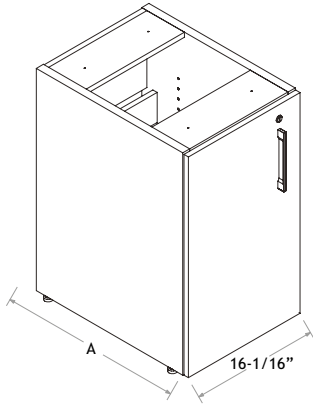

Color Combinaison

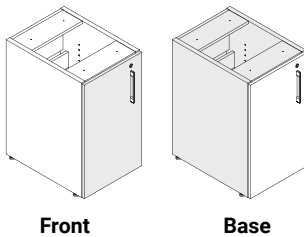

Depth of Leg

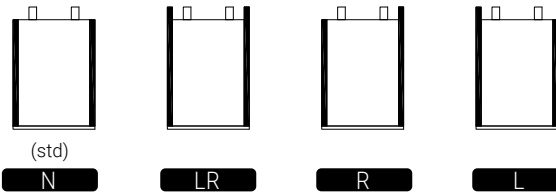

Manufacturing Standards

Independant cabinet:

- Cabinet without top;
- 2-3/8" back and sides recess for wire management;
- Fix to the panel using L bracket. The positioning brackets on the back allow you to leave a 2-3/8" wiring space and to attach the pedestal to the division panels or to the low walls.
- 14-3/32"H opening in the back, concealed with a removable panel;
- White nylon levelers;
- Handles H071BL;
- Lock;
- Height: 28"H;
- Adjustable shelf.
- Attention: This pedestal is designed for use under a work surface or a return. A fitted surface - 16" wide - is not possible due to the width of the pedestal (16 1/16").

To use with power walls and division panels.

Remove lock as option, no extra charge.

Specify if different handle desired (no extra charge, [see p. 98](#)).

Prices

Dimensions	
A	
20	725
24	787
30	849

How to Order

	ARLIND ARRIND	A	R L LR N (STD)	H071BL (std)	N LKSN LKBL (STD)
Series	XT				
Product	ARLIND				
Depth		20			
Full depth placket			N		
Handle				H071BL	
Lock					LKBL

Independant Pedestals

Independant cabinet with two doors

ARIND

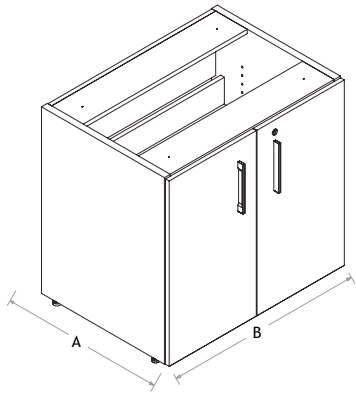

Color Combainson

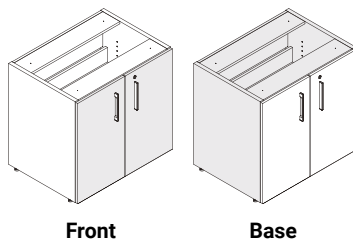

Depth of Leg

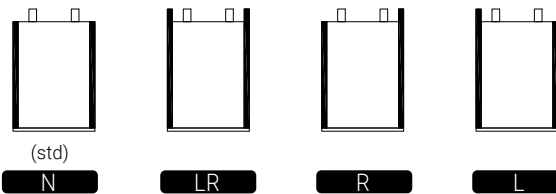

Manufacturing Standards

Independant cabinet with two doors:

- Cabinet without top;
- 1 adjustable shelf;
- 2-3/8" back and sides recess for wire management;
- Fix to the panel using L bracket. The positioning brackets on the back allow you to leave a 2-3/8" wiring space and to attach the pedestal to the division panels or to the low walls.
- 14-3/32"H opening in the back, concealed with a removable panel;
- White nylon levelers;
- Handles H071BL;
- Lock;
- Height: 28"H.

To use with power walls and division panels.

Remove lock as option, no extra charge.

Specify if different handle desired (no extra charge, [see p. 98](#)).

Prices

Dimensions	
A	B
20 24	877
20 30	935
20 36	976
20 42	1016
<hr/>	
24 24	901
24 30	960
24 36	1001
24 42	1040

How to Order

XT	A	B	ARIND	R L LR N (std)	H071BL (std)	N LKSN LKBL (std)
Series	Depth	Width	Product	Full depth placket	Handle	Lock
Example XT	20	24	ARIND	N	H071BL	LKBL

Independant Pedestals

Independant bookcase

BBLIND

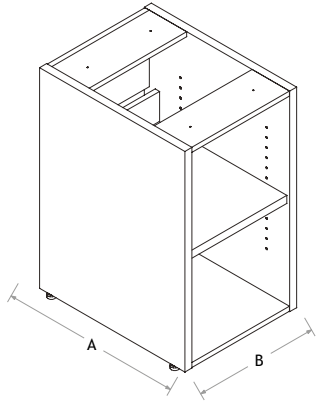

Color Combaision

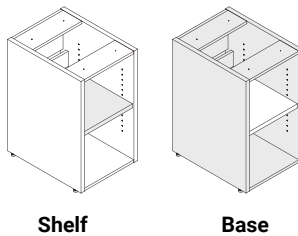

Shelf

Base

Depth of Leg

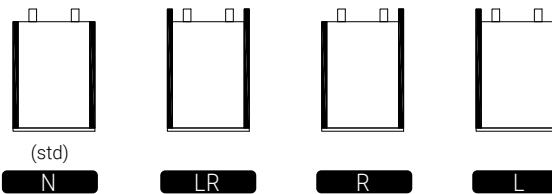

(std)

N

LR

R

L

Manufacturing Standards

Independant bookcase:

- Bookcase without top;
- 1 adjustable shelf, 1" thick;
- 2-3/8" back and sides recess for wire management;
- Fix to the panel using L bracket. The positioning brackets on the back allow you to leave a 2-3/8" wiring space and to attach the pedestal to the division panels or to the low walls.
- 14-3/32"H opening in the back, concealed with a removable panel;
- White nylon levelers;
- Height: 28"H.

To use with power walls and division panels.

Prices

Dimensions	
A	B
20 16	662
20 24	725
24 16	725
24 24	787
30 16	787
30 24	849

How to Order

XT	A	B	BBLIND	R L LR N (std)
Series	Depth	Width	Product	Full depth placket

Example XT 20 16 BBLIND N

Independant Pedestals

Independant lateral Filing cabinet

CLIND

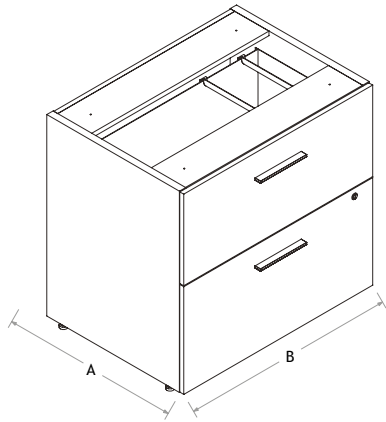

Color Combinaison

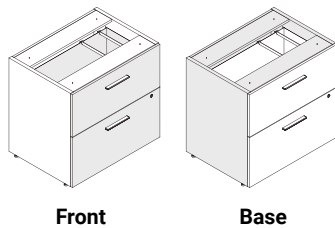

Depth of Leg

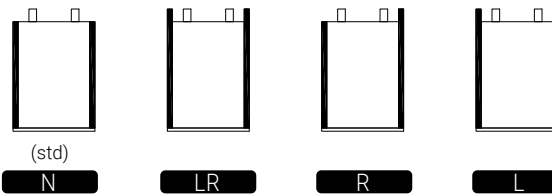

Manufacturing Standards

Independant Lateral Filing cabinet:

- Cabinet without top;
- 2 lateral filing drawers;
- 2 crossbars per file drawer;
- 2-3/8" back and sides recess for wire management;
- Fix to the panel using L bracket. The positioning brackets on the back allow you to leave a 2-3/8" wiring space and to attach the pedestal to the division panels or to the low walls.
- 14-3/32"H opening in the back;
- White nylon levelers;
- Handles H071BL;
- Lock;

To use with power walls and division panels.

Remove lock as option, no extra charge.

Specify if different handle desired (no extra charge, [see p. 98](#)).

Prices

Dimensions	
A	B
20 30	1096
20 36	1188
20 42	1276
24 30	1121
24 36	1212
24 42	1301

How to Order

XT	A	B	CLIND	R L LR N (STD)	H071BL (std)	N LKSN LKBL (std)
Series	Depth	Width	Product	Full depth placket	Handle	Lock
Example XT	20	30	CLIND	N	H071BL	LKBL

Mobile pedestal



Mobile pedestal with cabinet

MOBARL

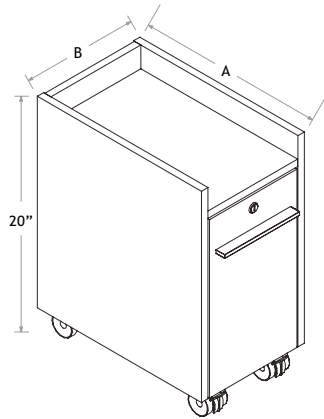

MOBARR

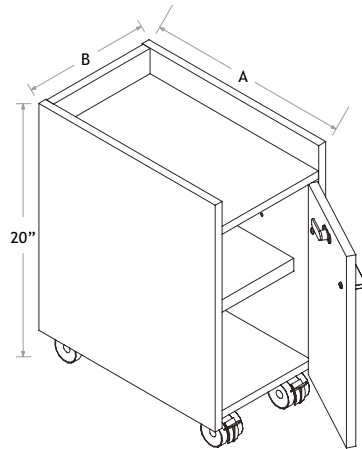

Manufacturing Standards

Mobile pedestal with 1-door cabinet:

- 1 storage on top;
- 4 black locking casters;
- Handle H071BL;
- Lock;
- Height: 20"H;
- 1 adjustable shelf.

Remove lock as option, no extra charge.

Specify if different handle desired (no extra charge, [see p. 98](#)).

Prices

Dimensions		
A	B	C
16	10	20
733		
16	16	20
747		

Color Combination

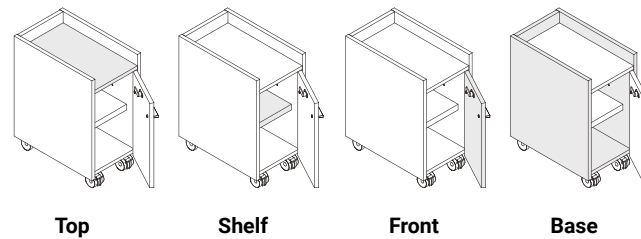

Top

Shelf

Front

Base

How to Order

	AB	MOBARL MOBARR	H071BL (std)	N LKSN LKBL (std)
XT				
Series	Dimensions	Product	Handle	Lock
Example XT	1610	MOBARL	H071BL	LKBL

Mobile pedestal



Mobile pedestal with 1 fixed shelf and 1 utility drawer

MOBSPU

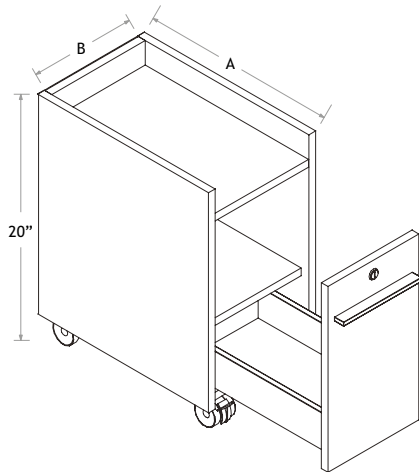

Manufacturing Standards

Mobile pedestal with 1 fixed shelf and 1 utility drawer at the bottom:

- 1 storage space on top (2"H);
- 1 utility drawer at the bottom;
- 4 black casters with lock;
- Handle H071BL;
- Lock;
- Height: 20"H.

Remove lock as option, no extra charge.

Specify if different handle desired (no extra charge, [see p. 98](#)).

Color Combination

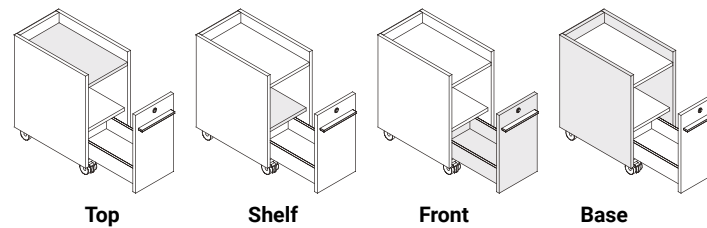

Top

Shelf

Front

Base

Prices

Dimensions		
A	B	C
16	10	20
16	16	20

How to Order

Series	Dimensions	Product	Handle	Lock	
XT	AB	MOBSPU	H071BL (std)	N LKSN LKBL (std)	
Example	XT	1610	MOBSPU	H071BL	LKBL

High Pedestals

High Pedestals

OK25

KO25

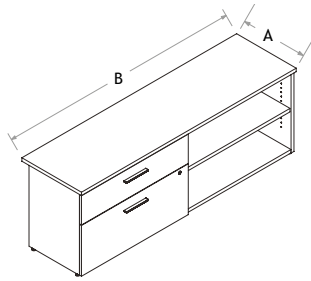
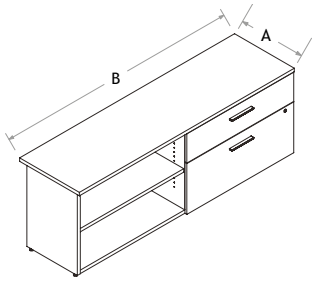

Color Combination

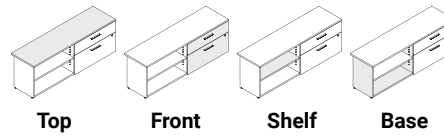

Top

Front

Shelf

Base

Depth of Leg

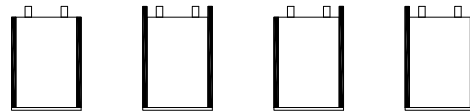

(std)

N

\$0

LR

\$0

R

\$0

L

\$0

Manufacturing Standards

High Pedestal:

- 1 open storage with 1 adjustable shelf;
- A section with 1 utility drawer with integrated dividers and 1 lateral file drawer.
- 2-3/8" back and sides recess for wire management;
- Fix to the panel using L bracket. The positioning brackets on the back allow you to leave a 2-3/8" wiring space and to attach the pedestal to the division panels or to the low walls.
- 12.5"H opening in the back, concealed with a removable panel on bookcase side;
- White nylon levelers;
- H071BL Handles;
- Lock;
- Height: 25"H.

For wire access: Removable back on bookcase side and opening on cabinet side.

Remove lock as option, no extra charge.

Specify if different handle desired (no extra charge, [see p. 98](#)).

Options

Surface 1½" for wiring

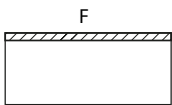

SP_

\$0

Cushion

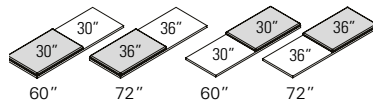

Cushion Left

Cushion Right

GRA	GR1	GR2	GR3	GR4	GR5	GR6	GR7	GR8	GR9	GR10	GR11	GR12	leather
\$361	\$373	\$391	\$409	\$432	\$453	\$476	\$499	\$520	\$543	\$564	\$610	\$654	\$618
\$361	\$373	\$391	\$409	\$432	\$453	\$476	\$499	\$520	\$543	\$564	\$610	\$654	\$618

Prices

Dimensions		
A	B	C
20	60	25
1812		
20	72	25
1899		

How to Order

XT	AB	OK25 K025	SPF SPN (std)	R L LR N (std)	CL CR N (std)	H071BL (std)	N LKS N LKBL (std)
Series	Dimensions	Product	Area Space 1½" for wiring	Full depth packet	Cushion	Handle	Lock
Example	XT	2060	OK25	SPN	N	N	H071BL
							LKBL

High Pedestals

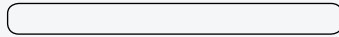

High Pedestals

OAR25

ARO25

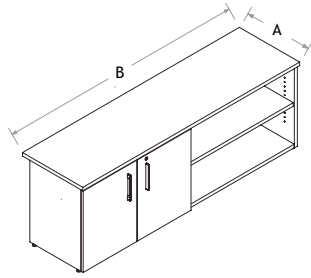
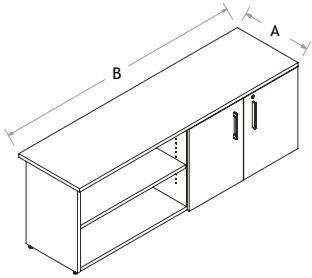

Color Combination

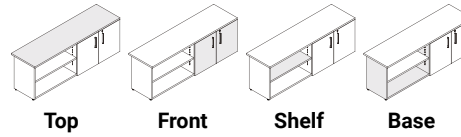

Top

Front

Shelf

Base

Depth of Leg

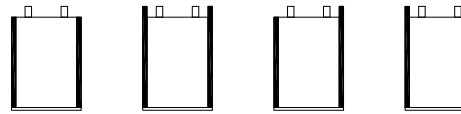

(std)

\$0 N

\$0 LR

\$0 R

\$0 L

Manufacturing Standards

High Pedestal:

- An open storage with 1 adjustable shelf;
- A 2-door cabinet section with 1 adjustable shelf;
- 2-3/8" back and sides recess for wire management;
- Fix to the panel using L bracket. The positioning brackets on the back allow you to leave a 2-3/8" wiring space and to attach the pedestal to the division panels or to the low walls.
- 12.5"H opening in the back, concealed with a removable panel on bookcase side and cabinet side;
- White nylon levelers;
- H071BL Handles;
- Lock;
- Height: 25"H.

For wire access: Removable back on bookcase side and opening on the armory section.

Remove lock as option, no extra charge.

Specify if different handle desired (no extra charge, [see p. 98](#)).

Options

Surface 1½" for wiring

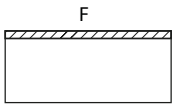

SP_ \$0

Cushion

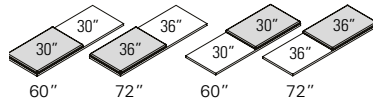

60"

72"

60"

72"

Cushion Left

Cushion Right

GRA	GR1	GR2	GR3	GR4	GR5	GR6	GR7	GR8	GR9	GR10	GR11	GR12	leather
\$361	\$373	\$391	\$409	\$432	\$453	\$476	\$499	\$520	\$543	\$564	\$610	\$654	\$618
\$361	\$373	\$391	\$409	\$432	\$453	\$476	\$499	\$520	\$543	\$564	\$610	\$654	\$618

Prices

Dimensions	A	B	C
20 60 25			1647
20 72 25			1749

How to Order

XT	AB	OAR25 ARO25	SPF SPN (std)	R L LR N (std)	CL CR N (std)	H071BL (std)	N LKS LKBL (std)
Series	Dimensions	Product	Area Space 1½" for wiring	Full depth placket	Cushion	Handle	Lock
Example XT	2060	OAR25	SPN	N	N	H071BL	LKBL

Benches

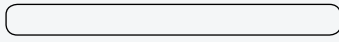

Benches with open storage

BO

BOO

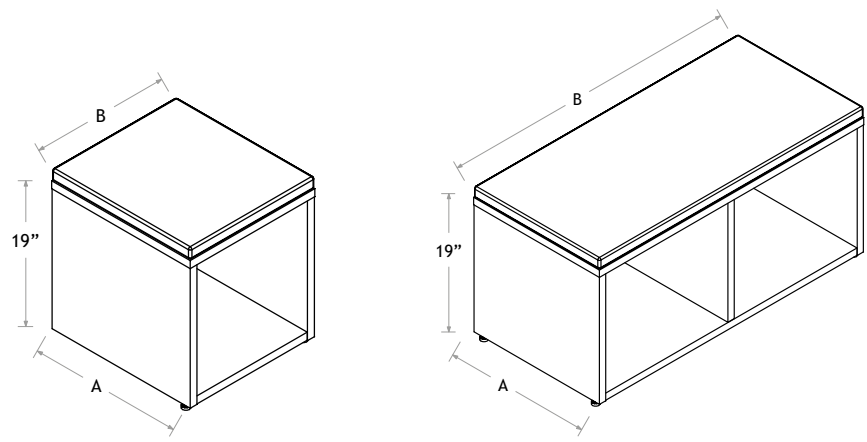

Manufacturing Standards

Bench with open storage:

- 1" laminate frame with full back;
- 1-1/2"H Full cushion;
- Open storage with interior space 18" x 16";
- White nylon levelers.

COM Fabrics: COM Fabrics are provided by the customer. For pricing please refer GR2 grade price.

Color Combinaison

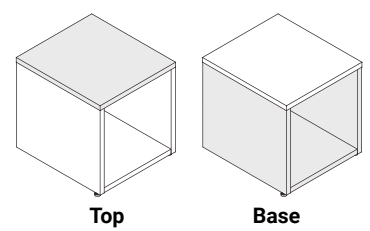

Prices

Dimensions			GRA	GR1	GR2	GR3	GR4	GR5	GR6	GR7	GR8	GR9	GR10	GR11	GR12	Cuir	Leather
A	B	C															
BO																	
20	18	19	451	470	493	517	547	577	607	636	666	695	726	785	845		795
BOO																	
20	42	19	733	760	796	831	877	922	966	1010	1055	1100	1144	1233	1323		1248

How to Order

XT	AB	BO BOO
Series	Dimensions	Product

Example **XT** 2018 BO

Benches

Benches with file drawer

BF

BFF

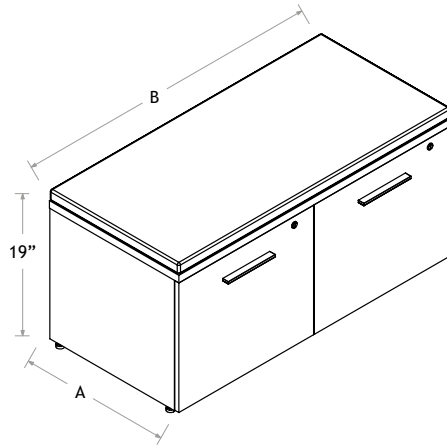
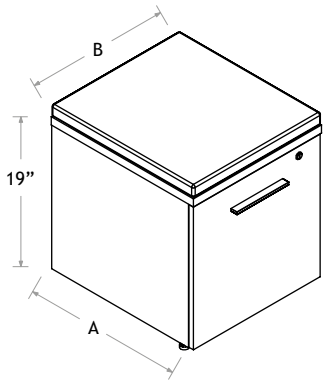

Color Combination

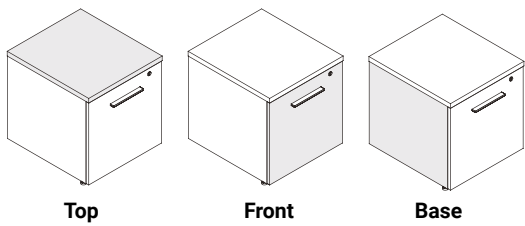

Top

Front

Base

Manufacturing Standards

Bench with open storage:

- 1" laminate frame with full back;
- 1-1/2"H Full cushion;
- 18"W: 1 file drawer (BF);
- 42"W: 2 file drawers (BFF);
- Handle H071BL;
- White nylon levelers;
- Lock.

Remove lock as option, no extra charge.

Specify if different handle desired (no extra charge, [see p. 98](#)).

COM Fabrics: COM Fabrics are provided by the customer. For pricing please refer GR2 grade price.

Prices

BF

Dimensions			GRA	GR1	GR2	GR3	GR4	GR5	GR6	GR7	GR8	GR9	GR10	GR11	GR12	Cuir Leather
A	B	C														
20	18	19	676	694	718	742	773	801	831	861	891	921	951	1010	1069	1020

BFF

Dimensions			GRA	GR1	GR2	GR3	GR4	GR5	GR6	GR7	GR8	GR9	GR10	GR11	GR12	Cuir Leather
A	B	C														
20	42	19	1195	1223	1258	1294	1338	1383	1428	1472	1516	1561	1606	1694	1785	1710

How to Order

XT	AB	BF BFF	H071BL (std)	N LKSN LKBL (std)
Series	Dimensions	Product	Handle	Lock
Example XT	2018	BF	H071BL	LKBL

Storage

Credenzas for Height Adjustable Table

KOEP

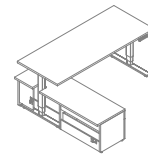
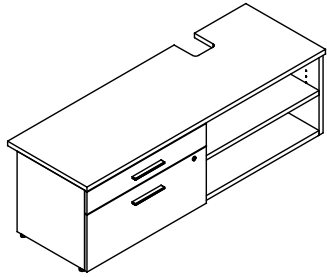

Depth of Leg

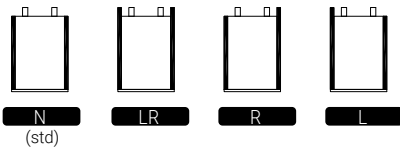

Color Combinations

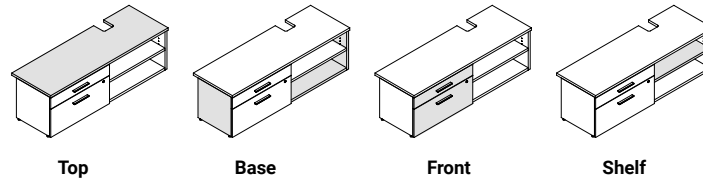

Manufacturing Standards

Credenza for Height Adjustable Table:

- Storage that integrates one of the legs of an Elevation Plus table. Fix to the panel using L bracket. The positioning brackets on the back allow you to leave a 2-3/8" wiring space and to attach the pedestal to the division panels or to the power walls;
- 1 utility drawer, 1 lateral file drawer for letter and legal formats, 1 open storage with 1 adjustable shelf;
- White nylon levelers;
- Interior height: 16-1/2"; Total height: 19".

For 29" deep tables only;

Not compatible with SMSS/SMUU modesties;

The table will be positioned with a clearance of 1" on the side and visitor side.

The SPF option is recommended when combined with electrical systems. It is recommended to install electrical systems below 18H, along with 12 additional inches of starter or jumper cable.

Handles: For handles other than H071BL standard, please choose from the Logiflex list at no extra charge.

Options

Surface 1 1/2" for wiring

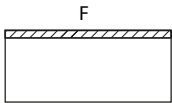

SP_ \$0

Cushion

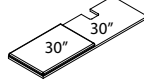

Cushion Left

GRA	GR1	GR2	GR3	GR4	GR5	GR6	GR7	GR8	GR9	GR10	GR11	GR12	leather
\$361	\$373	\$391	\$409	\$432	\$453	\$476	\$499	\$520	\$543	\$564	\$610	\$654	\$618

Prices

Dimensions

A	B
20 60	1751
24 60	1828

How to Order

XT	AB	KOEP	SPF SPN (std)	R L LR N (std)	CL N (std)	H071BL (std)	N LKSN LKBL (std)
Serie	Dimensions	Product	1 1/2" wiring space	Depth of leg	Cushion	Handle (p.98)	Lock
Example XT	2060	KOEP	SPN	N	N	H071BL	LKBL

Storage

Credenzas for Height Adjustable Table

OKEP

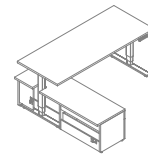
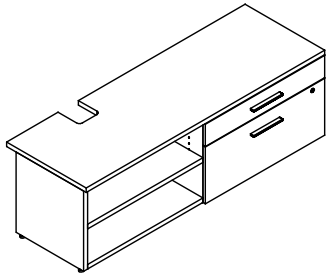

Depth of Leg

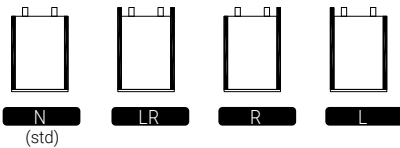

Color Combinations

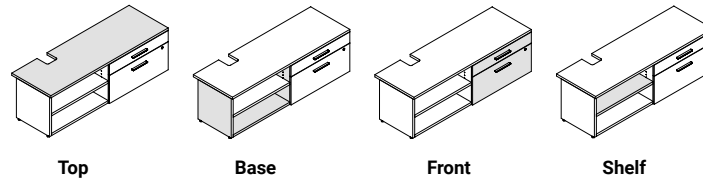

Manufacturing Standards

Credenza for Height Adjustable Table:

- Storage that integrates one of the legs of an Elevation Plus table. Fix to the panel using L bracket. The positioning brackets on the back allow you to leave a 2-3/8" wiring space and to attach the pedestal to the division panels or to the power walls;
- 1 utility drawer, 1 lateral file drawer for letter and legal formats, 1 open storage with 1 adjustable shelf;
- White nylon levelers;
- Interior height: 16-1/2"; Total height: 19".

For 29" deep tables only;

Not compatible with SMSS/SMUU modesties;

The table will be positioned with a clearance of 1" on the side and visitor side.

The SPF option is recommended when combined with electrical systems. It is recommended to install electrical systems below 18H, along with 12 additional inches of starter or jumper cable.

Handles: For handles other than H071BL standard, please choose from the Logiflex list at no extra charge.

Options

Surface 1 1/2" for wiring

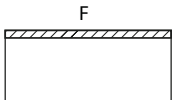

SP_ \$0

Cushion

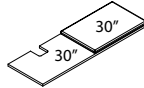

Cushion Right

GRA	GR1	GR2	GR3	GR4	GR5	GR6	GR7	GR8	GR9	GR10	GR11	GR12	leather
\$361	\$373	\$391	\$409	\$432	\$453	\$476	\$499	\$520	\$543	\$564	\$610	\$654	\$618

Prices

Dimensions

A	B
20 60	1751
24 60	1828

How to Order

XT	AB	OKEP	SPF SPN (std)	R L LR N (std)	CR N (std)	H071BL (std)	N LKSN LKBL (std)
Serie	Dimensions	Product	1 1/2" wiring space	Depth of leg	Cushion	Handle (p.98)	Lock
Example XT	2060	OKEP	SPN	N	N	H071BL	LKBL

Storage

Bookcase for Height Adjustable Table

BBLEP

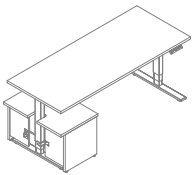
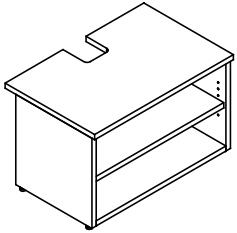

Color Combinations

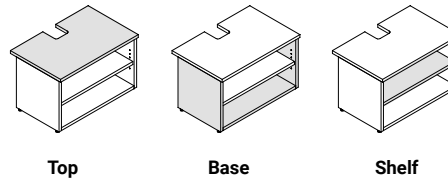

Depth of Leg

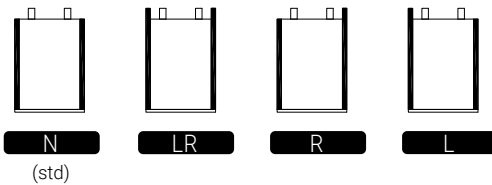

Options

1 1/2" Wiring Space

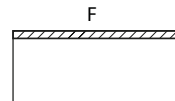

SP_
\$0

Manufacturing Standards

Bookcase for Height Adjustable Table:

- Bookcase that integrates one of the legs of an Elevation Plus table. Fix to the panel using L bracket. The positioning brackets on the back allow you to leave a 2-3/8" wiring space and to attach the pedestal to the division panels or to the powerwalls;
- 1 adjustable shelf;
- White nylon levelers;
- Interior height: 16-1/2";
Total height: 19".

For 29" deep tables only;

Not compatible with SMSS/SMUU modesties;

The table will be positioned with a clearance of 1" on the side and visitor side.

The SPF option is recommended when combined with electrical systems. It is recommended to install electrical systems below 18H, along with 12 additional inches of starter or jumper cable.

Prices

Dimensions

A	B
20 31	906
24 31	939

How to Order

XT	AB	BBLEP	SPF SPN (std)	R L LR N (std)
Serie	Dimensions	Product	1 1/2" wiring space	Depth of Leg

Example XT 2060 BBLEP SPN

Storage towers

Sliding storage

SL01L

SL01R

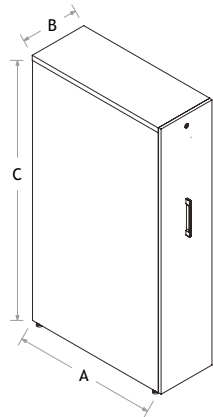
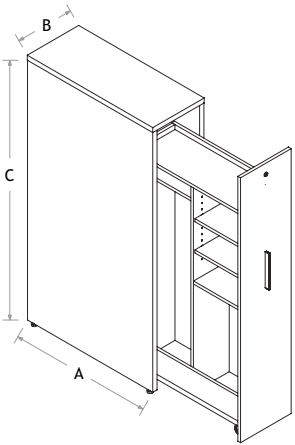

Color Combination

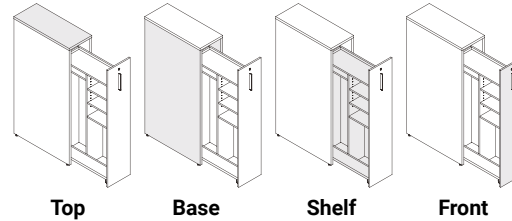

Manufacturing Standards

Sliding storage:

- 1 cloakroom section with 1 fixed shelf and a hook;
- 1 storage section with 1 fixed shelf and:
 - 42"H : 1 adjustable shelf
 - 54"H : 2 adjustable shelves
- Removable panel at the back for wire access. There is no removable back if the tab notch option is chosen;
- Unit on slides and casters, with soft close system;
- Handle H071BL;
- Lock;
- White nylon levelers.

Remove lock as option, no extra charge.

Specify if different handle desired (no extra charge, [see p. 98](#)).

Options

Tab with notch for wire management

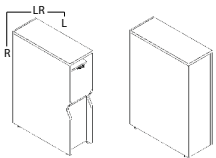

MG_ \$0

MGN \$0

Cutouts for socket (plug not included)

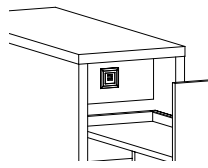

P1 \$0

Prices

Dimensions

A	B	C
30	12	42
30	12	54

2598

2723

How to Order

Series	Dimensions	Product	Tab with notch for wire management	Cutout for socket	Handle	Lock	
Example	XT	301242	SL01L	MGN	N	H071BL	LKBL

Storage towers

Cabinet with coat hook

ARHL

ARHR

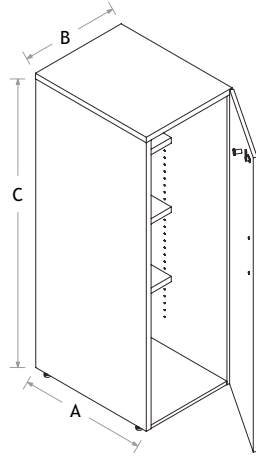
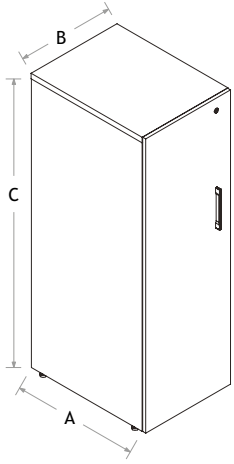

Color Combinaison

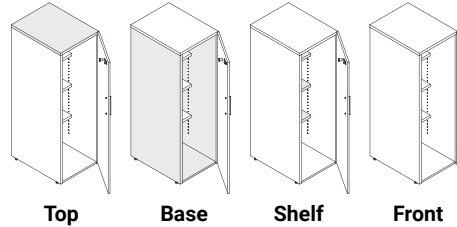

Manufacturing Standards

Cabinet with coat hook:

- Cabinet with 1 door;
- 2 adjustable shelves 42"H;
- 3 adjustable shelves 54"H;
- Coat hook on cabinet door;
- Ventilation grill at the bottom;
- Handle H071BL;
- Lock;
- White nylon levelers;
- Space of 10-1/4" in front of the adjustable shelves for a mantel. (For the 2 depths, the shelves change in depth).

Remove lock as option, no extra charge.

Specify if different handle desired (no extra charge, [see p. 98](#)).

Options

Tab with notch for wire management

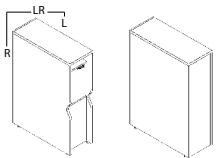

MG_ \$0

MGN \$0

Prices

Dimensions		
A	B	C
20	18	42
24	18	42
20	18	54
24	18	54

How to Order

XT	ABC	ARHL ARHR	MGR MGLR MGRR MGN (std)	H071BL (std)	N LKSN LKBL (std)
Series	Dimensions	Product	Tab with notch for wire management	Handle	Lock
Example XT	201842	ARHL	MGN	H071BL	LKBL

Storage towers

Bookcase with drawers

BBUF

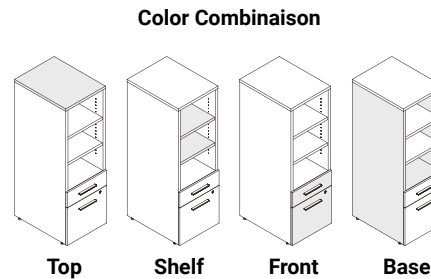
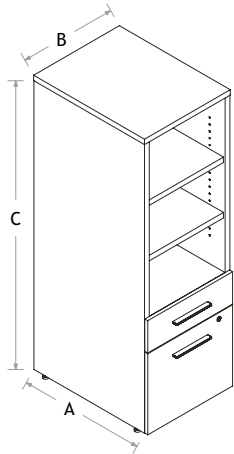

Manufacturing Standards

Bookcase with drawers:

- Open storage with 1 adjustable shelf for the 42"H cabinet, 2 adjustable shelves for the 54"H cabinet;
- 1 utility drawer;
- 1 lateral file drawer;
- Handles H071BL;
- Lock.
- White nylon levelers.

Remove lock as option, no extra charge.

Specify if different handle desired (no extra charge, [see p. 98](#)).

Options

Tab with notch for wire management

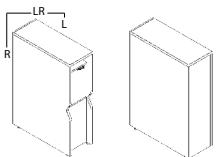

MG_
\$0

MGN
\$0

Prices

Dimensions		
A	B	C
20	18	42
24	18	42
<hr/>		
20	18	54
24	18	54

How to Order

Series	Dimensions	Product	Tab with notch for wire management	Handle	Lock	
Example	XT	201842	BBUF	MGN	H071BL	LKBL

Storage towers

Cabinet with drawers

ARUFL

ARUFR

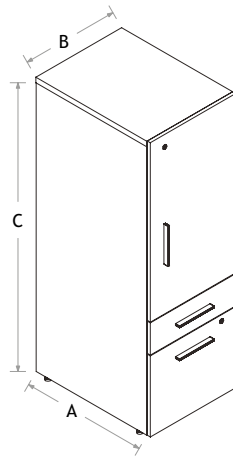
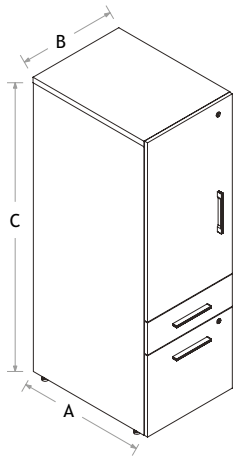

Color Combinaison

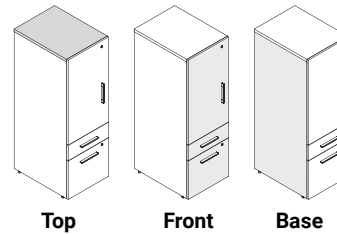

Manufacturing Standards

- Cabinet with 1 door, 1 utility drawer and 1 lateral file drawer:
- 1 cabinet section with 1 adjustable shelf for the 42"H cabinet with drawers, 2 adjustable shelves for the 54"H cabinet with drawers;
 - 1 utility drawer;
 - 1 lateral file drawer;
 - Handles H071BL;
 - Lock;
 - White nylon levelers.

Remove lock as option, no extra charge.

Specify if different handle desired (no extra charge, [see p. 98](#)).

Options

Tab with notch for wire management

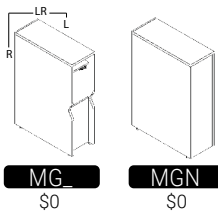

MG_ \$0

MGN \$0

Prices

Dimensions		
A	B	C
20	18	42
24	18	42
20	18	54
24	18	54

How to Order

XT	ABC	ARUFL ARUFR	MGR MGLR MGRR MGN (std)	H071BL (std)	N LKSN LKBL (std)
Series	Dimensions	Product	Tab with notch for wire management	Handle	Lock
Example XT	201842	ARUFR	MGN	H071BL	LKBL

Islands Stations

Island station

USF

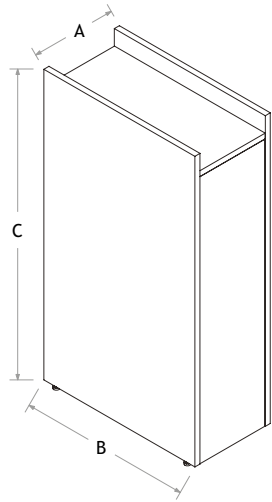

Color Combinaison

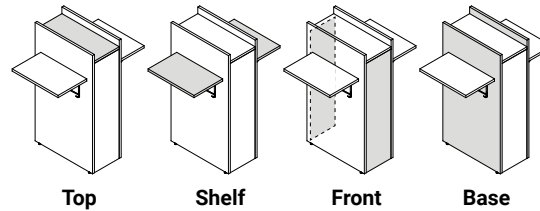

Manufacturing Standards

Island station :

- 1" laminate frame;
- Removable end panels for wire management;
- White nylon levelers;
- Maximum capacity of 50kg excluding the shelf.

Options :

Exterior shelf height:
 36"H Island Station : 29"H surface
 42"H Island Station : 29"H surface
 54"H Island Station : 36"H surface

Exterior shelf depth: 15".

Cutouts for socket: 2 by side.

For outlet, please refer to the [Accessory](#) section.

Options

Cutouts for socket (plug not included)

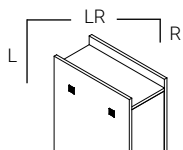

PL \$0
PR \$0
PLR \$0

Shelf

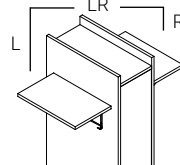

L \$194
LR \$388
R \$194

Prices

Dimensions			
A	B	C	
15	30	36	857
15	36	36	887
15	42	36	912
15	30	42	887
15	36	42	912
15	30	54	936
15	36	54	961

How to Order

XT	ABC	USF	PL PR PLR N (std)	L R LR N (std)	WH SN BL (std)
Series	Dimensions	Product	Cutout for socket	Shelf	Metal
Example XT	153036	USF	N	N	BL

Island station with Bookcase - 1 side

USBB

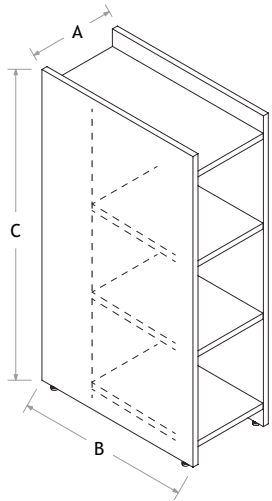

Color Combinaison

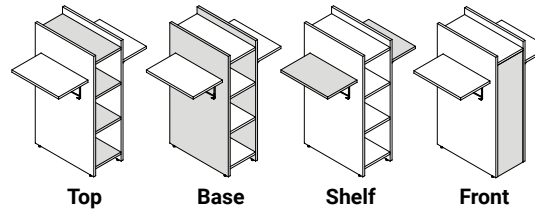

Manufacturing Standards

Island Station with Bookcase - 1 side

- 1" laminate frame;
- Bookcase on 1 side with:
 - 36"H: 2 open spaces 13 1/4"H (int.)
 - 42"H: 2 open spaces 16 1/4"H (int.)
 - 54"H: 3 open spaces 14 1/2"H (int.)
- Interior fixed shelves, not full depth;
- Removable end panel for wire management;
- Maximum capacity of 50kg excluding the shelf;
- White nylon levelers.

Options :

Outdoor shelf height: 29" (Island Station 36"H & 42"H), 42" (Island Station 54"H).

Outdoor shelf depth: 15".

Cutouts for socket: 1 by side.

For outlet, please refer to the [Accessory](#) section.

Options

Cutouts for socket (plug not included)

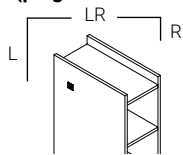

PL \$0 PR \$0 PLR \$0

Shelf

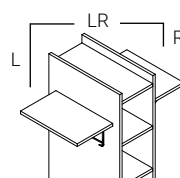

L \$194 LR \$388 R \$194

Prices

Dimensions			Interior depth shelf:
A	B	C	
15	30	36	857 18 5/8"
15	36	36	887 21 5/8"
15	42	36	912 24 5/8"
<hr/>			
15	30	42	887 18 5/8"
15	36	42	912 21 5/8"
<hr/>			
15	30	54	936 18 5/8"
15	36	54	961 21 5/8"

How to Order

XT	ABC	USBB	PL PR PLR N (std)	L R LR N (std)	WH SN BL (std)
Series	Dimensions	Product	Cutout for socket	Shelf	Metal
Example XT	153036	USBB	N	N	BL

Islands Stations

Island station with lockers - 1 side

USLOR

USLOL

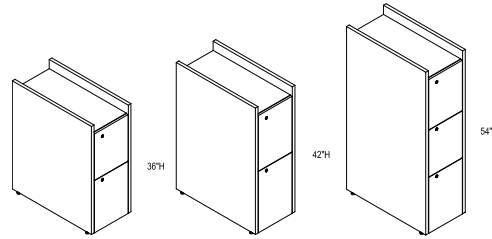
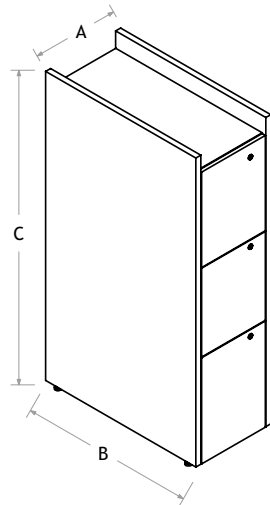
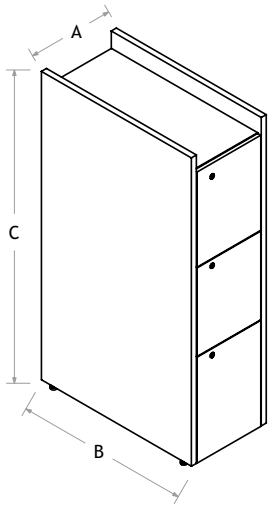

Color Combination

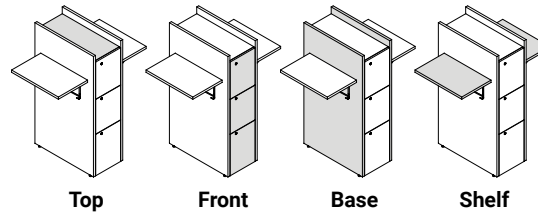

Manufacturing Standards

Island Station with lockers - 1 side:

- 1" laminate frame;
- XY'D Lockers on 1 side with:
 - 36"H: 2 open spaces 13 1/4"H (int.)
 - 42"H: 2 open spaces 16 1/4"H (int.)
 - 54"H: 3 open spaces 14 1/2"H (int.)
- Doors with key locks and push-to-open latch;
- Removable end panel for wire management;
- Maximum capacity of 50kg excluding the shelf;
- White nylon levelers;
- Interior shelves not full depth.
- Locker interior dimension:
 - 30"H: 18 5/16" (int.)
 - 36"H: 21 5/16" (int.)
 - 42"H: 24 5/16" (int.)

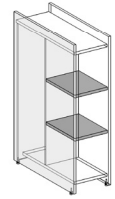

Options

Lock

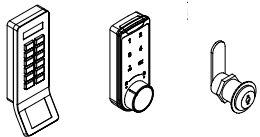

E1 \$281 ea.
E2 \$169 ea.
CMLK \$0

Cutouts for socket (plug not included)

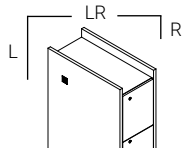

PL \$0
PR \$0
PLR \$0

Shelf

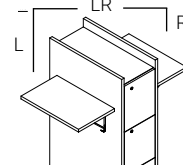

L \$194
LR \$388
R \$194

Options :

Outdoor shelf height: 29" (Island Station 36"H & 42"H), 42" (Island Station 54"H).

Outdoor shelf depth: 15".

Cutouts for socket: 1 by side.

For outlet, please refer to the [Accessory](#) section.

Prices

Dimensions	
A	B C
15 30 36	1471
15 36 36	1603
15 42 36	1732
15 30 42	1603
15 36 42	1864
15 30 54	1770
15 36 54	2031

How to Order

XT	ABC	USLOR USLOL	E1 E2 N CMLK(std)	PL PR PRL N (std)	L R LR N (std)	WH SN BL (std)
Series	Dimensions	Product	Lock	Cutout for socket	Shelf	Metal
Example XT	153036	USLOR	E1	N	N	BL

Accessories

Handles

HJA

Handle

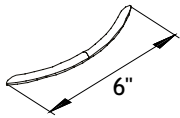

- 6" metal handle;
- 5-1/32" (128mm) center to center.

Code	\$	Description
HJA	15	<i>Satin Nickel</i>
HJAB	15	<i>Black</i>

H070

Handle

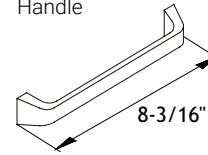

- 8-3/16" metal handle;
- 7-1/2" (190.5mm) center to center.

Code	\$	Description
H070BN	15	<i>Brushed Nickel</i>
H070CHR	15	<i>Chrome</i>

H011

Handle

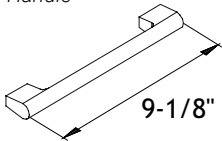

- 9-1/8" metal handle;
- 8-13/16" (224mm) center to center.

Code	\$	Description
H011	15	<i>Satin Nickel</i>

H071

Handle

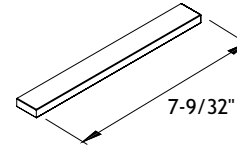

- 7-9/32" metal handle;
- 6-5/16" (160.338mm) center to center.

Code	\$	Description
H071CHR	15	<i>Chrome</i>
H071BN	15	<i>Brushed Nickel</i>
H071BL	15	<i>Black</i>
H071WH	15	<i>White</i>

H051

Handle

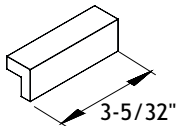

- 3-5/32" metal handle;
- 2-17/32" (64mm) center to center.

Code	\$	Description
H051CHR	15	<i>Chrome</i>
H051SN	15	<i>Satin Nickel</i>
H051BL	15	<i>Black</i>
H051WH	15	<i>White</i>

H072

Handle

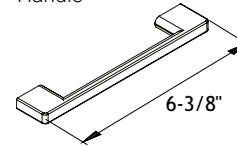

- 6-3/8" metal handle;
- 5-1/32" (127.8mm) center to center.

Code	\$	Description
H072CHR	15	<i>Chrome</i>
H072BL	15	<i>Black</i>
H072WH	15	<i>White</i>

H052

Handle

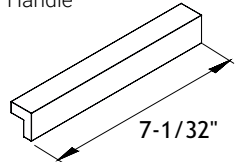

- 7-1/32" metal handle;
- 6-9/32" (160mm) center to center.

Code	\$	Description
H052CHR	15	<i>Chrome</i>
H052SN	15	<i>Satin Nickel</i>
H052BL	15	<i>Black</i>
H052WH	15	<i>White</i>

SXP002

Handle

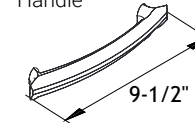

- 9-1/2" metal handle;
- 7-9/16" (192mm) center to center.

Code	\$	Description
SXP002	15	<i>Satin Nickel</i>

H060

Handle

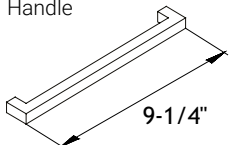

- 9-1/4" metal handle;
- 8-3/4" (222.25mm) center to center.

Code	\$	Description
H060BN	15	<i>Brushed Nickel</i>
H060CHR	15	<i>Chrome</i>

SXP003

Handle

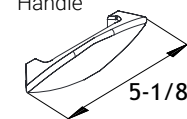

- 5-1/8" metal handle;
- 3-25/32" (96mm) center to center.

Code	\$	Description
SXP003	15	<i>Satin Nickel</i>

Accessories

Keyboard Trays

KB360M

Keyboard Tray

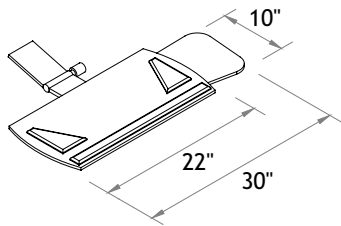

- Black plastic 24-1/2" wide retractable ergonomic keyboard;
- Lift-N-Lock spring system (no lever) to adjust height;
- Handle for easy tilt adjustment from 10° to 15°;
- 10" x 7-1/2" mouse tray;
- 19" black gel wrist rest;
- 360° rotation.

Code	\$	Description
KB360M	665	

KB

Keyboard Tray

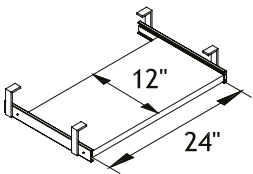

- 24" wide keyboard tray only;
- 5/8" and 1" thick laminate;
- Adjustable height from 1-3/4" to 2-3/4" / additional 2" for slides.

Code	\$	Description
KB	210	1" thick laminate
KBT	198	5/8" thick laminate

KBMOD

Keyboard Tray

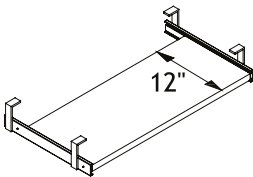

- Keyboard tray, available in lengths from minimum 24" to maximum 30";
- 5/8" and 1" thick laminate;
- Adjustable height from 1-3/4" to 2-3/4" / additional 2" for slides.

Code	\$	Description
KBMOD	252	1" thick laminate
KBMODT	240	5/8" thick laminate

To order, for example a 27" long keyboard tray, 5/8" thick laminate: KBMODT27

KBMODR

Keyboard Tray

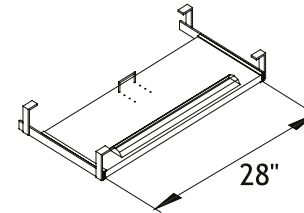

- 28" wide keyboard tray;
- 1" thick laminate;
- Adjustable height from 1-3/4" to 2-3/4" / additional 2" for slides;
- Black gel wrist rest / depth-adjustable stop handles.

Code	\$	Description
KBMODR	341	

AP

Wrist Rest

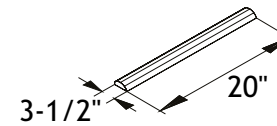

- Black gel wrist rest.

Code	\$	Description
AP	80	

Accessories

CPU Holders

MCPU50

Miniature CPU Holder

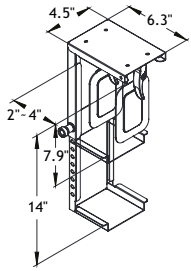

- Height adjustable: 8" - 14";
- Width adjustable: 2" - 4";
- Maximum capacity: 10 kg (22 lbs);
- Need a minimum 5" deep clearance.

Code	\$	Description
MCPU50	185	

MCPU90

CPU Holder

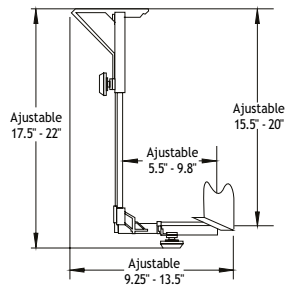

- Black metal CPU holder;
- Easy manipulation;
- Vertical adjustment:
 - Height: 15.5" x 20"
 - Width: 5.5" x 9.8"
- Horizontal adjustment:
 - Height: 17.5" x 22"
 - Width: 9.25" x 13.5"

Code	\$	Description
MCPU90	234	<i>per unit</i>

CPUIND

CPU Holder

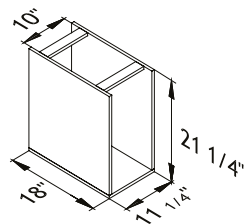

- 5/8" thick laminate CPU holder;
- 10" x 20" interior

Code	\$	Description
CPUIND	199	<i>per unit</i>

Accessories

Computer Monitor Brackets

C-1A

Computer Monitor Bracket

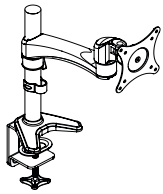

- Computer monitor bracket with fixed arm support;
- Height-adjustable arm;
- Clamp mounted;
- Finish: Black.

Code	\$	Description
C-1A	150	

C-1B

Computer Monitor Bracket

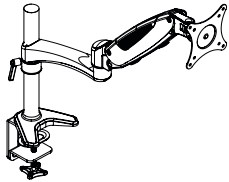

- Computer monitor bracket with flexible arm support;
- Height-adjustable arm;
- Clamp mounted;
- Finish: Black.

Code	\$	Description
C-1B	255	

C-2A

Double Computer Monitor Bracket

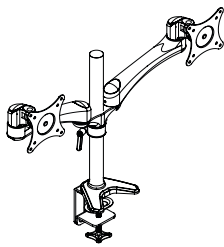

- Double computer monitor bracket with fixed arm support;
- Height-adjustable arms;
- Clamp mounted;
- Finish: Black.

Code	\$	Description
C-2A	254	

C-2B

Double Computer Monitor Bracket

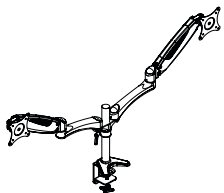

- Double computer monitor bracket with flexible arm support;
- Height-adjustable arms;
- Clamp mounted;
- Finish: Black.

Code	\$	Description
C-2B	452	

C-2A-1S

Triple Computer Monitor Bracket

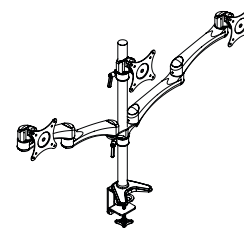

- Triple computer monitor bracket with fixed arm support;
- Height-adjustable arms;
- Clamp mounted;
- Finish: Black.

Code	\$	Description
C-2A-1S	438	

C-2B-1S

Triple Computer Monitor Bracket

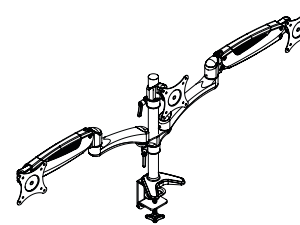

- Triple monitor bracket with 2 flexible arm supports;
- Height-adjustable arms;
- Clamp mounted;
- Finish: Black.

Code	\$	Description
C-2B-1S	496	

SHIFT-2A

Shift Double Monitor arm with Docking

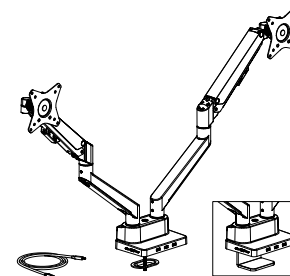

- 17" to 32" dual monitor arm support with flexible arms;
- 75mm and 100mm versa plate;
- Height adjustable arms that holds up to 8 kg (each);
- Clamp or Grommet mounted;
- Finish: Black;
- 8-in-1 Multiport docking station with:
 - 1 x Type - C Power distribution Port (100w)
 - 1 x Type - C Upstream port with type C cable included
 - 3 x USB-A Downstream ports
 - 2 x HDMI 2.0 Ports
 - 1 x RJ45 Ethernet port

Power distribution cable not included, follow electronic devices input recommendations.

Code	\$	Description
SHIFT-2A	764	

Accessories

Computer Monitor Brackets

BRSC1M4

Monitor Arm

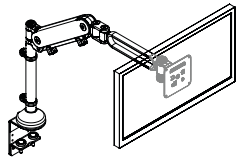

- Monitor arm with height-adjustable arm, clamp-mounted;
- Finish: Satin nickel.

Code	\$	Description
BRSC1M4	776	

This is a Human Scale product.

BRSC1M7

Monitor Arm

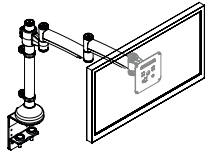

- Monitor arm with fixed-height arm, clamp-mounted;
- Finish: Satin nickel.

Code	\$	Description
BRSC1M7	547	

This is a Human Scale product.

BRSC2M4

Double Monitor Arm

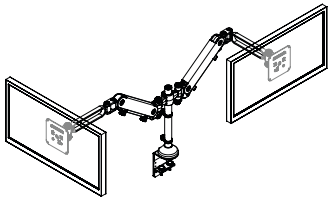

- Double monitor arm with height-adjustable arm, clamp-mounted;
- Finish: Satin nickel.

Code	\$	Description
BRSC2M4	1364	

This is a Human Scale product.

BRSC2M7

Double Monitor Arm

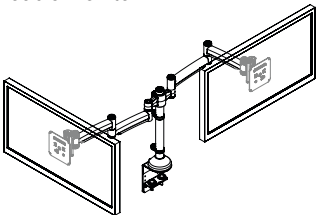

- Double monitor arm with fixed-height arm, clamp-mounted;
- Finish: Satin nickel.

Code	\$	Description
BRSC2M7	847	

This is a Human Scale product.

BRSG1M4

Computer Monitor Bracket

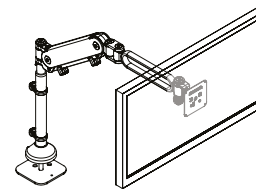

- Computer monitor bracket with height-adjustable arm;
- Grommet mounted;
- Finish: Satin Nickel.

Code	\$	Description
BRSG1M4	745	

This is a Human Scale product.

BRSG1M7

Computer Monitor Bracket

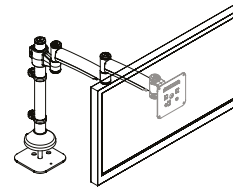

- Computer monitor bracket with fixed-height arm;
- Grommet mounted;
- Finish: Satin Nickel.

Code	\$	Description
BRSG1M7	510	

This is a Human Scale product.

BRSG2M4

Double Computer Monitor Bracket

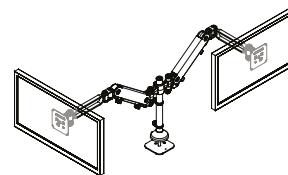

- Double computer monitor bracket with height-adjustable arm;
- Grommet mounted;
- Finish: Satin Nickel.

Code	\$	Description
BRSG2M4	1354	

This is a Human Scale product.

BRSG2M7

Double Computer Monitor Bracket

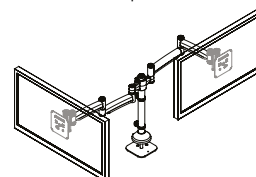

- Double computer monitor bracket with fixed height;
- Grommet mounted;
- Finish: Satin Nickel.

Code	\$	Description
BRSG2M7	809	

This is a Human Scale product.

Accessories



Miscellaneous Accessories

LK

Lock/key

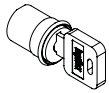

- Locks with keys
- Finish: Satin nickel or black finish;
- Additional locks, sold separately or factory installed;
- Please specify the type of furniture on which the will be installed.

Code	\$	Description
LKSN	47	Satin Nickel lock (factory installed)
LKBL	47	Black lock (factory installed)

LKSNF	31	Satin Nickel front lock
LKBLF	31	Black front lock

LKSNP	31	Satin Nickel door lock
LKBLP	31	Black door lock

KEY	26	Set of 2 keys - #501 - 600
SERR 010	26	1 master key

TCPM

Sliding Drawer

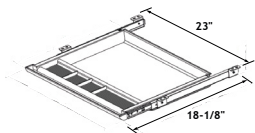

- Black plastic sliding drawer with steel ball bearing slides.

Code	\$	Description
TCPM	210	

SWV

Swivel Organizer Tray

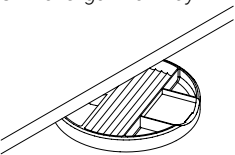

- Storage drawer that rotate 360 degrees;
- Mounts flush to the edge;
- Dimensions: 7-1/2"D x 8-7/8"W x 1"H.

Code	\$	Description
SWV	68	

SB

Suspension Bars

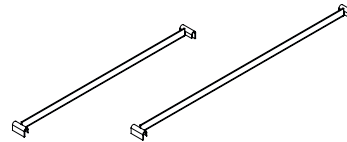

- Short suspension bars: 1 or 2 suspension bars for a left/right filing for a regular file drawer;
- Long suspension bars: 1 or 2 suspension bars for a front/back filing for a lateral file drawer.

Code	\$	Description
SBV1	7	1 short suspension bar
SBV2	14	2 short suspension bars
SBH1	7	1 long suspension bar
SBH2	14	2 long suspension bars

IGS

Installation guide for surface supports



- Compatible with; CNT01/CNT02/CNT03/CNTC01/CNTC02;
- 1" laminate;
- White nylons levelers;
- Dimensions: 10"W x 28" H;
- It is recommended for every 10 workstations to have 1x IGS.

Code	\$	Description
IGS	137	

IGWM

Installation guide for 1 1/2" wire management space for surfaces

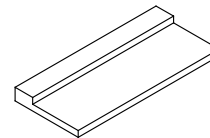

- 1" laminate;
- Dimensions: 5-3/8" D x 12"L;
- It is recommended for every 10 workstations to have 2x IGWM.

Code	\$	Description
IGWM	55	

Accessories



Miscellaneous Accessories

IGEAS

Installation guide

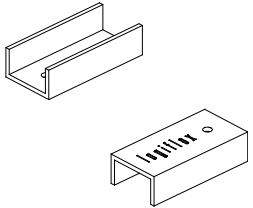

- Installation guide for acrylic divider on panel XT EAS;
- Yellow PLA plastic ;

Code	S	Description
IGEAS	46	

ME2

Master key for E2 lock

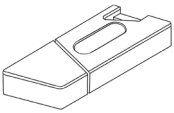

- Master key for E2 lock:
- To unlock and reinitialise E2 electronic lock;

Code	S	Description
ME2	249	

CHE1

Charger for E1 lock

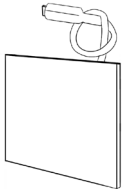

- Charger for E1 lock:
- Emergency battery charger to unlock E1 lock.

Code	S	Description
CHE1	128	

Accessories

Electrical Accessories

BE-KDHB-1

Single sided power block (1)

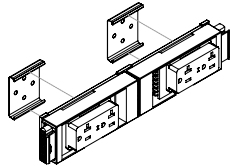

Set including:

- Single sided power block (1);
- 2 Duplex -1 circuit;
- 2 mounting plates;
- Max. 10 duplex per circuit (5 double half power block BE-KDHB-1).

Code	\$	Description
BE-KDHB-1-BL	219	
BE-KDHB-1-WH	231	

BE-KDHB-4

Single sided power block (2)

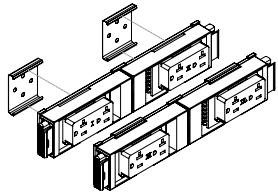

Set including:

- Single sided power block (2);
- 4 Duplex -1 of each circuit;
- 4 Mounting plates;
- Max. 40 duplex (20 double half power block).

Code	\$	Description
BE-KDHB-4-BL	450	
BE-KDHB-4-WH	460	

BE-KDBSM-1

Double sided power block

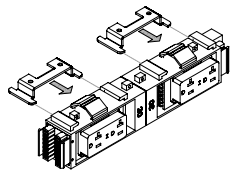

Set including:

- Double sided power block;
- 4 duplex -1 circuit;
- 2 slide mounting brackets;
- Max. 10 duplex per circuit (2 double power block).

Code	\$	Description
BE-KDBSM-1-BL	422	
BE-KDBSM-1-WH	441	

BE-KDBSM-4

Double sided power block

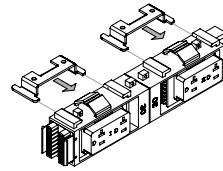

Set including:

- Double sided power block;
- 4 duplex -1 of each circuit;
- 2 slide mounting brackets;
- Max. 40 duplex (10 double power block).

Code	\$	Description
BE-KDBSM-4-BL	422	
BE-KDBSM-4-WH	441	

BE-WMS-32

Power and data cable support single sided (1)

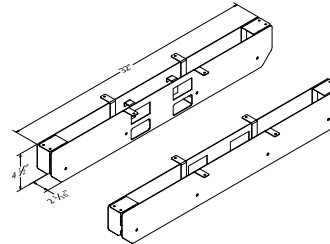

- 32" metal wire management system for power block BE-DHB and 2 telecom plate cutouts
- Channel to isolate power cables from data cables.
- Screws included to install the channel under a top.
- Power block, duplexes and telecom plates not included
- Colors : Black or white.

Code	\$	Description
BE-WMS-32-BL	281	Black
BE-WMS-32-WH	281	White

BE-WMD-32

Power and data cable support double sided (1)

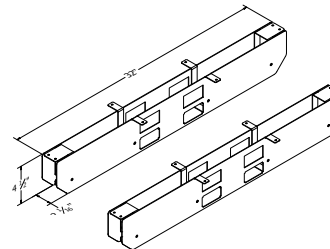

- 32" metal wire management system for power block BE-DBSM and 4 telecom plate cutouts.
- Channel to isolate power cables from data cables.
- Screws included to install the channel under a top.
- Power block, duplexes and telecom plates not included
- Colors : Black or white.

Code	\$	Description
BE-WMD-32-BL	281	Black
BE-WMD-32-WH	281	White

Accessories

Electrical Accessories

SMWM

Cable Support

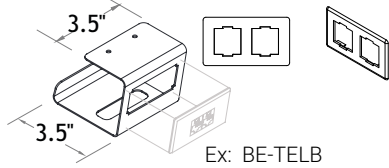

- 3.5" metal wire support with 1 telecom plate cutout;
- Satin nickel finish.

Code	\$	Description
SMWM	31	

BE-TELA

Telecom plate

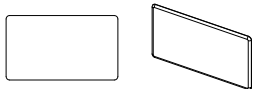

- Blank plate;
- 3-1/8" x 1-3/4";
- Colors: Black, White and Satin nickel;
- To be used with the APB, APF or AP2 access panel option of the supply walls.

Code	\$	Description
BE-TELA-BL	6	
BE-TELA-WH	6	
BE-TELA-SN	6	

BE-TELB

Telecom plate

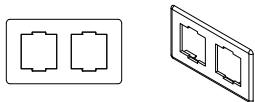

- 2 spaces to install connection ports;
- 3-1/8" x 1-3/4";
- Adapter included.
- Colors: Black, White and Satin nickel.

Code	\$	Description
BE-TELB-BL	6	
BE-TELB-WH	6	
BE-TELB-SN	6	

BE-HW

Hardwired conduit power entry



- * To be connected to an electrical box by an electrician.
- 8 wires - 4 circuits **20 Amp**;
- For 8 trac system;
- Bare wires at one end
- Male end.

Code	\$	Description
BE-HW-72	197	8 wire, 4 circuit - 72"L
BE-HW-84	214	8 wire, 4 circuit - 84"L
BE-HW-96	239	8 wire, 4 circuit - 96"L
BE-HW-120	279	8 wire, 4 circuit - 120"L
BE-HW-180	409	8 wire, 4 circuit - 180"L



BE-PI72

Corded Power entry

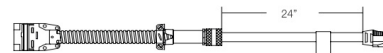

- Corded power entry of 72";
- Right angle 20 Amp plug;
- Male end;
- 1 circuit **20 Amp**;
- Must be plug on **20 Amp** outlet

Code	\$	Description
BE-PI72	244	



Accessories

Electrical Accessories

BE-NYHW

NYC flex hardwired power infeed



- * To be connected to an electrical box by an electrician.
- 8 wires - 4 circuits **20 Amp**;
- Bare wires at one end;
- For 8 trac system;
- Male end.

Code	\$	Description
BE-NYHW-72	444	
BE-NYHW-84	467	
BE-NYHW-96	483	
BE-NYHW-108	507	
BE-NYHW-120	526	

BE-J

M/M jumper



- Not-adjustable;
- 8 wire - 4 circuits;
- M/M;
- For 8 trac system;
- Minimum 12" - Maximum 216".

Code	\$	Description
BE-J12	126	8 wire cable / 4 circuit - 12"L
BE-J18	134	8 wire cable / 4 circuit - 18"L
BE-J24	142	8 wire cable / 4 circuit - 24"L
BE-J36	155	8 wire cable / 4 circuit - 36"L
BE-J42	165	8 wire cable / 4 circuit - 42"L
BE-J48	175	8 wire cable / 4 circuit - 48"L
BE-J54	182	8 wire cable / 4 circuit - 54"L
BE-J60	198	8 wire cable / 4 circuit - 60"L
BE-J66	206	8 wire cable / 4 circuit - 66"L
BE-J72	216	8 wire cable / 4 circuit - 72"L
BE-J78	229	8 wire cable / 4 circuit - 78"L
BE-J84	240	8 wire cable / 4 circuit - 84"L
BE-J96	259	8 wire cable / 4 circuit - 96"L
BE-J120	302	8 wire cable / 4 circuit - 120"L
BE-J216	561	8 wire cable / 4 circuit - 216"L

BE-HC

Harness connector F/F

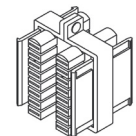

- Used to connect jumper cables;
- 1-1/2" x 2-1/4".

Code	\$	Description
BE-HC	59	

BE-DHB

Single sided power block

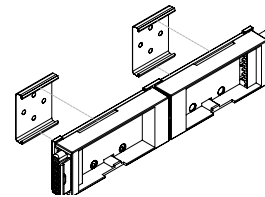

- Maximum of 2 duplex per block;
- Includes mounting plates ;
- F/F ;
- For 8-trac system ;
- Duplex ordered separately.

Code	\$	Description
BE-DHB	114	

BE-DBSM

Double sided power block

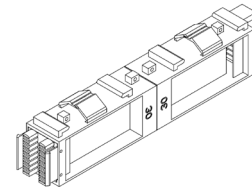

- Maximum of 4 duplex per block;
- For 8-trac system ;
- Slide mounting sold separately ;
- F/F ;
- Duplex ordered separately.

Code	\$	Description
BE-DBSM	165	

BE-D20-C

Duplex

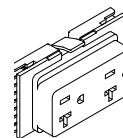

- **20 Amp**;
- Height 1-1/18";
- For BE-DHB & BE-DBSM blocks ;
- Colors: Black or white ;
- Maximum of 10 Duplex per circuit.

Code	\$	Description
BE-D20-C-1-BL	52	Circuit 1 - 20A - Black
BE-D20-C-2-BL	52	Circuit 2 - 20A - Black
BE-D20-C-3-BL	52	Circuit 3 - 20A - Black
BE-D20-C-4-BL	52	Isolated Circuit 4 - 20A - Black
BE-D20-C-1-WH	59	Circuit 1 - 20A - White
BE-D20-C-2-WH	59	Circuit 2 - 20A - White
BE-D20-C-3-WH	59	Circuit 3 - 20A - White
BE-D20-C-4-WH	59	Isolated Circuit 4 - 20A - White

Accessories

Electrical Accessories

BE-SM58-2

Slide mount bracket

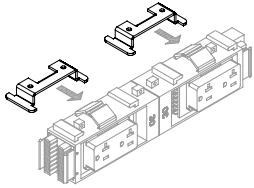

- 2 brackets;
- Only for the double power block (BE DBSM);
- 5/8" height;
- Screws included.

Code	\$	Description
BE-SM58-2	45	

WM

Velcro Tie



- Velcro tie for electrical cable;
- The non-metallic buckle is safe to use around electrical devices;
- Dimensions: ¾" x 10";
- Color: black.

Code	\$	Description
WM	14	Unit price
WMS	15	with #8, 9/16" Robertson screw, per unit

SQC

Ports USB A+C

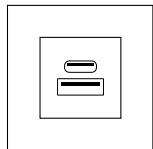

- Dual charger USB A+C;
- 72" cable;
- Finish: Black, Dusk, Navy, Storm

Code	\$	Description
SQC-72-C	303	Black
SQC-72-JM	303	Dusk
SQC-72-JL	303	Navy
SQC-72-JK	303	Storm

SQE

Electric plug

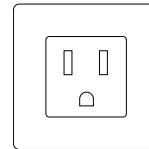

- Electric plug;
- Cable - 120";
- Finish: Black, Dusk, Navy, Storm.

Code	\$	Description
SQE-120-C	146	Black
SQE-120-JM	146	Dusk
SQE-120-JL	146	Navy
SQE-120-JK	146	Storm

SQU

USB port

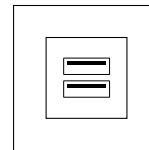

- 2 USB ports (passive);
- USB M/F cable - 72";
- Finish: Black, Dusk, Navy, Storm.

Code	\$	Description
SQU-72-C	240	Black
SQU-72-JM	240	Dusk
SQU-72-JL	240	Navy
SQU-72-JK	240	Storm

BR1

Power unit

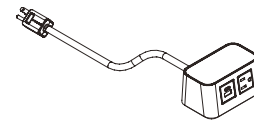

- 1 power outlet / 1 dual charger USB-a+c;
- Table top with braided storm 120 IN power cord.

Code	\$	Description
BR1BL	564	Black
BR1WH	564	White

BR2

Power unit

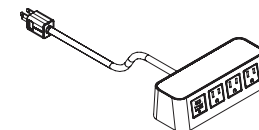

- 3 power outlet / 1 dual charger USB-a+c;
- Table top with braided storm 120 IN power cord.

Code	\$	Description
BR2BL	726	Black
BR2WH	726	White

Accessories

Electrical Accessories

BCSS1BL

Communication Box

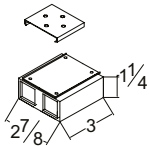

- Communication box to be installed under surface;
- 2 empty telecommunication outlets (outlets not included);
- 15A/125V;
- 1 set of universal adapters.

Code	\$	Description
BCSS1BL	186	Available in black only

BCSS2BL

Communication Box

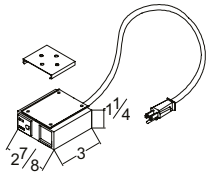

- Communication box to be installed under surface;
- 1 electrical outlet and 1 empty telecommunication outlet (outlet not included);
- 72" power cable with electric plug;
- 15A/125V;
- 1 set of universal adapters.



Code	\$	Description
BCSS2BL	186	Available in black only

BCSS3BL

Communication Box

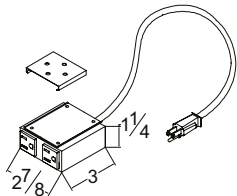

- Communication box to be installed under surface;
- 2 electrical outlets;
- 72" power cable with electric plug;
- 15A/125V;
- 1 set of universal adapters.



Code	\$	Description
BCSS3BL	186	Available in black only

POR 01

RJ45, CAT 6 connectivity port

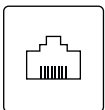

- RJ45, CAT6 connector;
- RJ45 M/F cable - 72";
- Finish: Black.

Code	\$	Description
POR 01	156	

POR 02

RJ11 connectivity port

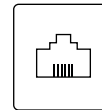

- RJ11 connector, 4 pin
- RJ11 M/F cable - 84";
- Finish: Black.

Code	\$	Description
POR 02	45	

POR 03

USB connectivity port

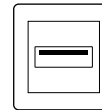

- 1 USB (data/passive);
- USB M/F cable - 72";
- Finish: Black.

Code	\$	Description
POR 03	96	

POR 04

HDMI connectivity port

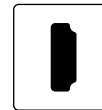

- HDMI connector;
- HDMI F/F cable - 18";
- Finish: Black.

Code	\$	Description
POR 04	142	

POR 05

Mini Stereo Jack

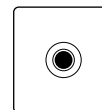

- 3.5 mm Mini Stereo Jack, M/F;
- Audio M/F cable -120";
- Finish: Black.

Code	\$	Description
POR 05	50	

POR 06

VGA Connector

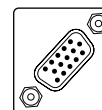

- VGA connector, 15 pin;
- VGA M/F cable -120";
- Finish: Black.

Code	\$	Description
POR 06	180	

Accessories

Electrical Accessories

PBL

Power bar

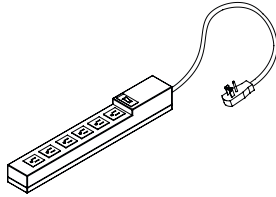

- Power bar with 6 electric outlets;
- 120" power cable with electric plug.



Code	\$	Description
PBL	70	

CT

Metal cable tray

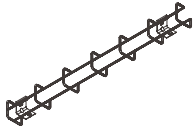

Metal cable tray

- In stainless steel;
- Dimensions: 2x4; Interior dimensions: 1-7/8"D x 1-7/8"H
- Length of 24" and 118" (118" can be cut on site).
- With mounting hardware

Code	\$	Description
CT24	121	
CT118	255	

DSG

Double-sided grommet



Double-sided grommet

- Hole diameter: 2.5"
- Use for electrical cable management with division panels. Drilling to be done by the installer. Double-sided grommet not designed for power walls.
- Grommet to cut on site for desired thickness to cover;
- *Can not be cut with a simple utility knife, use a sharper and safer tool.*

Code	\$	Description
DSG BL	31	Black
DSG WH	31	White

WMP

Wire Management Pole

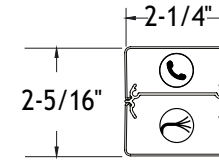

- Blank steel pole to bring cables from the ceiling to a work station;
- Satin nickel finish with a grey boot base;
- 2 compartments: 1 power/1 communications
- Mounting hardware, entrance end plate and ceiling trim plate included;
- Wires and outlets not included;
- Height: 12' 5".

Code	\$	Description
WMP	492	

As our product line is constantly evolving and expanding, we recommend that you visit logiflex.ca for updates.

logiflex

1235 St-Roch N., Sherbrooke QC J1N 0H2 Canada
T : 1.877.864.9323 | F : 1.800.474.7830 | logiflex.ca