

logiflex

USER GUIDE

E1 Lock

OVERVIEW



FEATURES

- Backlit keyboard when in use for easy reading;
- Stainless steel material;
- 2 types of use: private or public;
- External emergency power supply;
- Codes ranging from 1 to 9 digits for multiple possibilities;
- 20-second alarm when an incorrect code or card is used 4 consecutive times;
- Possibility of user card, sold separately

ITEMS

- Lock (included);
- Chip (included);
- User card (not included);
- Emergency battery charger (not included).

OVERVIEW

[See the E1 lock guide here](#)
[See the instruction videos of the E1 lock](#)

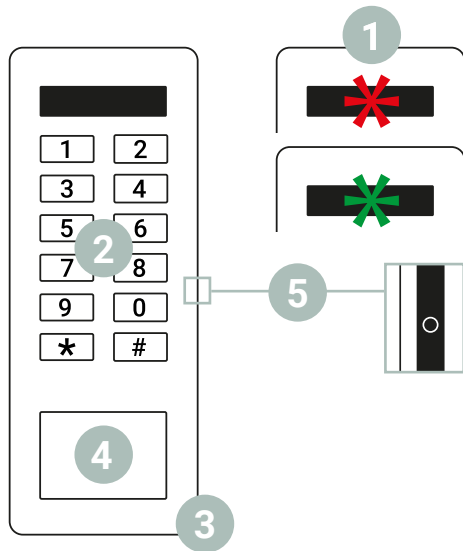

Front case, front view

1. Green or red indicator
2. Keyboard
3. Handle
4. Inductive zone
5. Emergency power port

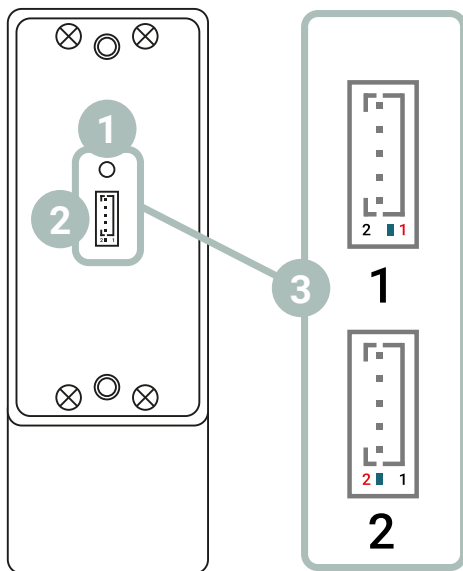

Front case, back view

1. Reset button
2. Plug hole
3. Switch for functionality (private or public)

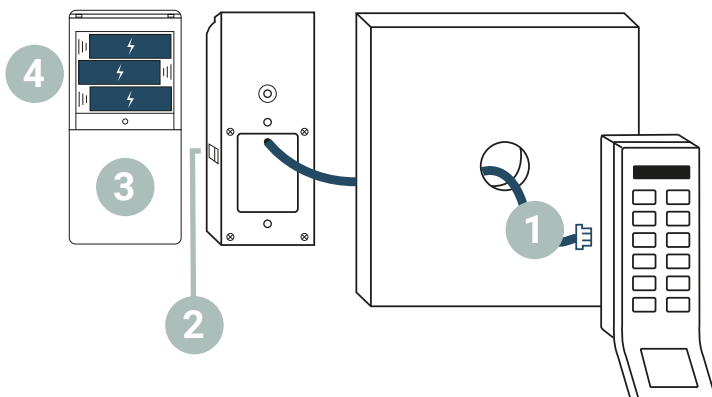

Rear case

1. Power plug
2. Latch
3. Battery holder
4. 3 AA alkaline batteries (not included)

ASSEMBLY INSTRUCTIONS

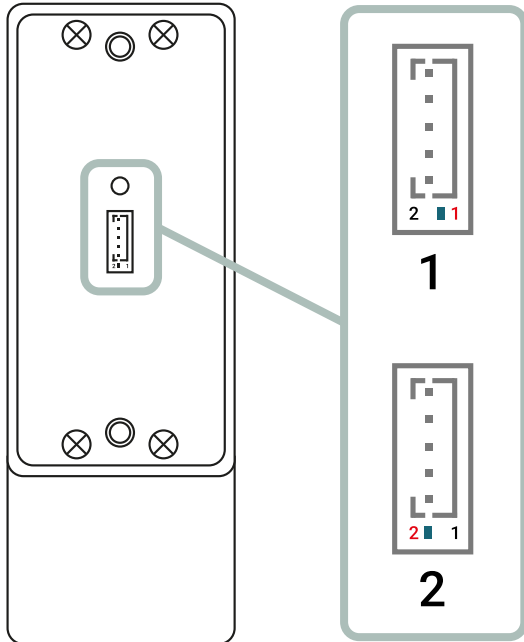

****IMPORTANT****

Determine the desired type of use BEFORE the initialization

Determine the desired type of use (private or public) and position the switch at the back of the lock according to the desired use. By default, the lock is in position 2 (Switch to the left).

Position 1 : Public use

The switch must be positioned on the right. This mode is appropriate in a locker room context assigned to a person. Assign a permanent code and the door locks automatically after opening.

Position 2 : Private use

The switch must be positioned on the left. This mode is suitable in a shared locker or unassigned locker context. The code is valid for one use only and the door remains unlocked between each use.

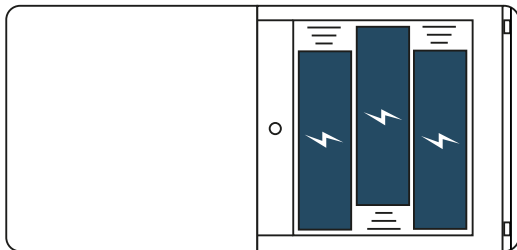

Batteries AA

Load 3 AA alkaline batteries (not included) into the battery holder

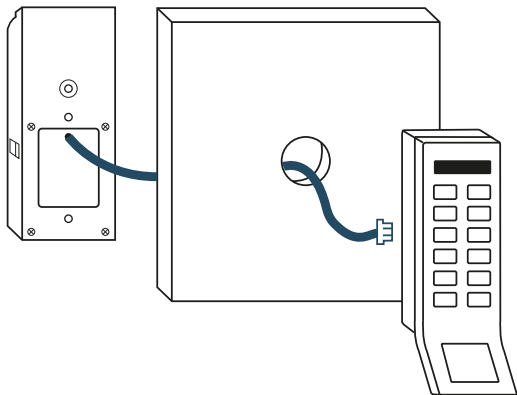

Case

Insert the plug of the rear case into the socket of the front case.

Initialization

Use a small sharp tool (one of the included screws can work) to press the reset button until 3 long beeps sound, indicating the lock has been successfully initialized. Remove the batteries to fix the cases. After fixing the 2 cases on the locker door, reinsert the batteries. After initialization, if any cards or digital codes had previously been programmed for this lock, they will be deleted.

USER GUIDE

Master chip

To be able to use the E1 electronic lock, one of the chips must be programmed as the master chip.

The master chip is used to:

- Unlock different locks from the same chip;
- Program or delete lock codes;
- Program or delete user cards.

Note that it is also possible to program a user card, sold separately, as a master card following the same procedure.

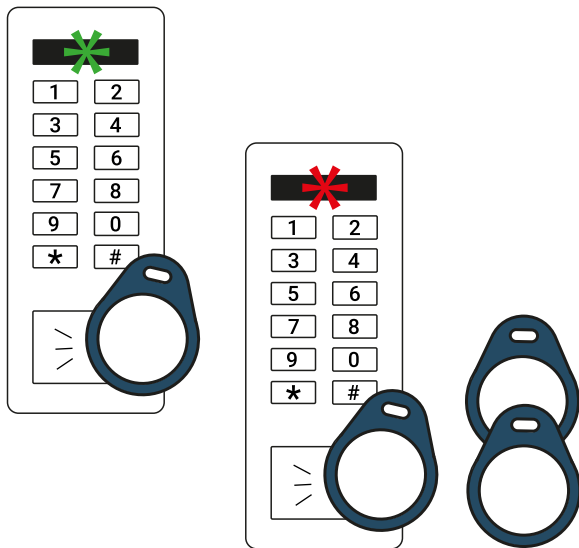

Programming a master chip

After lock initialization, put the chip on the inductive zone. After 3 long beeps and flashes of the green indicator, the programmed chip becomes the master chip.

During the red indicator flashing period, up to 2 more chips can be added as master chips.

The programming of 3 master chips is recommended in case chips are lost.

To program a new master chip while the red indicator is flashing, the programming procedure is:

* -> master chip -> # -> new master chip.

Maximum of 3 master chips. After programming a 4th master chip, the 1st master chip that was programmed is deleted.

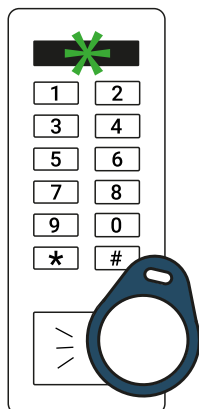

Use a master chip

Put the master chip to the inductive zone. The green indicator comes on with a beep and the lock is unlocked.

- In private use (position 1), the red indicator comes on for 5 seconds, then the lock locks automatically.
- In public use (position 2), the lock remains unlocked.

USER GUIDE

Lock with permanent code - Private use

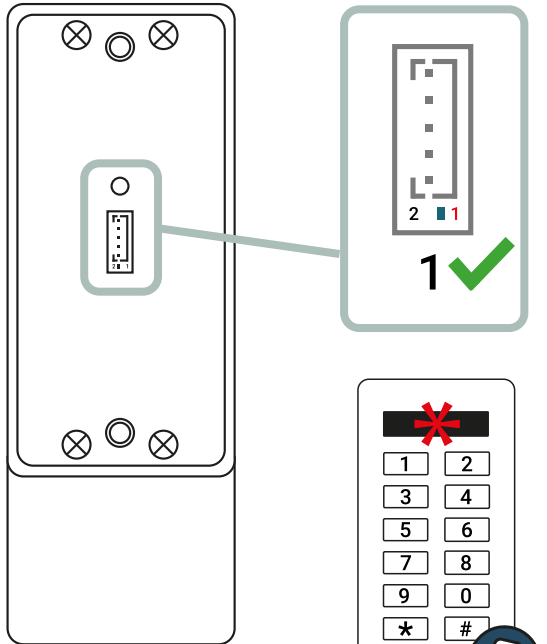

Program the digital code

****IMPORTANT****

For private use, the switch must have been placed in position 1 (switch on the right) at the time of installation.

Put the master chip on the inductive zone. After a beep, the lock is unlock and the red indicator will blink. Scan the master chip on the inductive zone again.

While it is blinking, enter a 1-to-9-digit code, then press #. After a long beep, the code you entered becomes the permanent code for this lock.

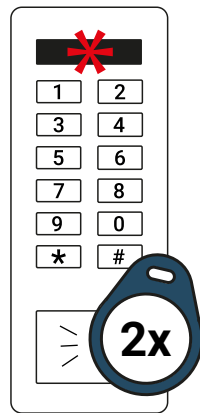

To delete the permanent code, scan the master chip on the inductive card zone 3 times. 3 short beeps will confirm that the permanent code is deleted.

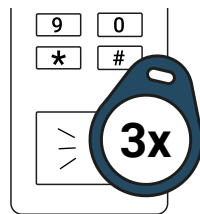

Use the digital code

Enter the previously programmed permanent numeric code, followed by #.

The lock unlocks and the red indicator comes on. After 5 seconds the lock will automatically lock.

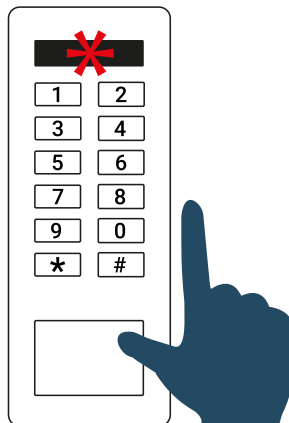

USER GUIDE

Lock with single use code - Public use

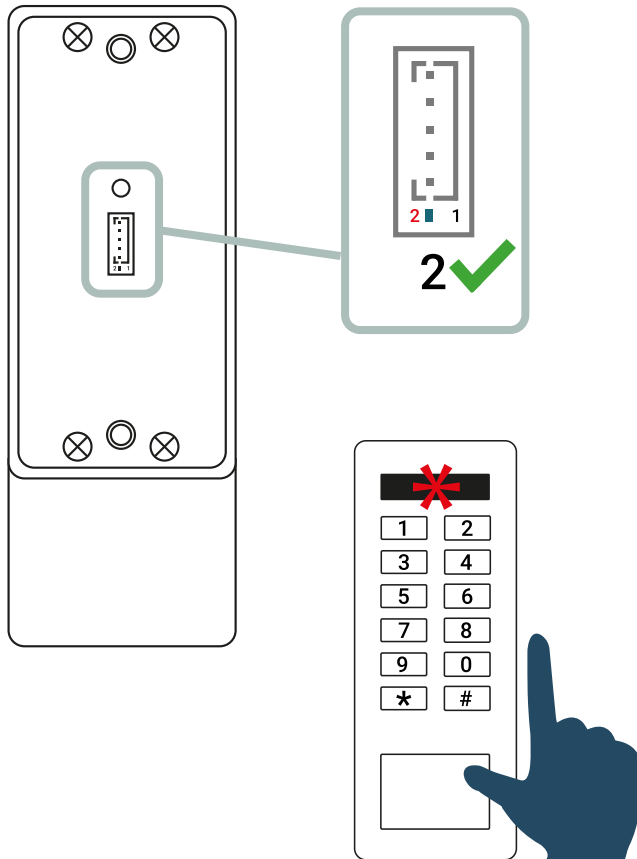

Program the digital code

****IMPORTANT****

For public use, the switch must have been placed in position 2 (switch on the left) at the time of installation.

The master chip programming step is necessary, even for public use.

Use the digital code

To lock the lock, keep the door closed and enter a 1 to 9 digit numeric code followed by #.

The red indicator flashes followed by 2 beeps while the lock locks.

To unlock the lock, enter the same digital code followed by #. The locker will be unlocked and will remain unlocked for the next use.

USER GUIDE

Lock with user card - Private or public use

User card not included.

The user card is used to replace the use of a code. It can be used in 2 types of use: private or public.

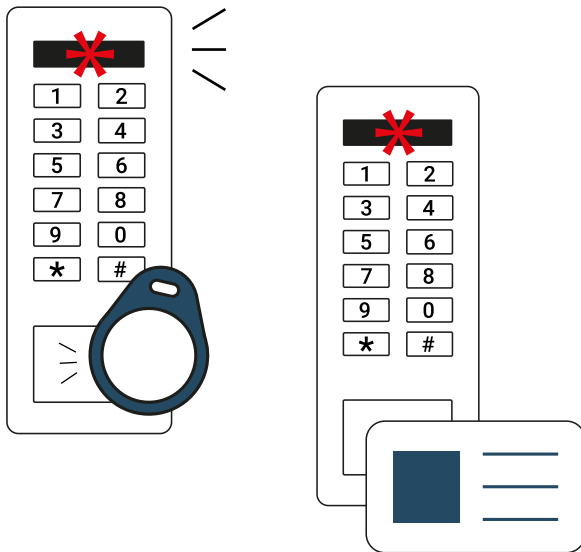

Program a user card

****IMPORTANT****

Determine the type of desired use BEFORE installation

The master chip programming step is necessary.

Scan the master chip on the inductive zone. After a beep, the red indicator will blink: scan the master chip again.

While it is blinking, scan a card on the inductive zone. After a beep, the programmed card becomes a user card attributed to this specific lock.

You can program up to 120 user cards, one after the other, for a same lock.

To delete user cards, pass the master chip over the inductive zone three times. After 3 long beeps, all user cards are deleted.

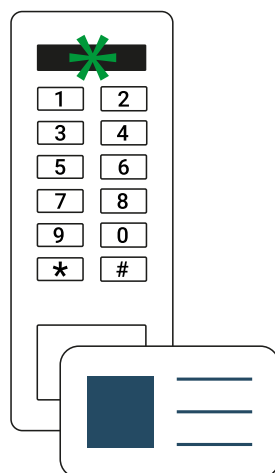

Use a user card

Lock

- Put the user card on the inductive zone. The green indicator comes on with a beep indicating that the door is unlocked.

Unlock

- In private use (position 1) after being unlocked, the red indicator comes on for 5 seconds, then the lock locks automatically.
- In public use (position 2), put the user card over the inductive zone to lock the door. 2 beeps with the red

BATTERY CHANGE

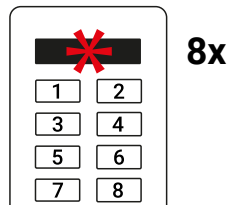
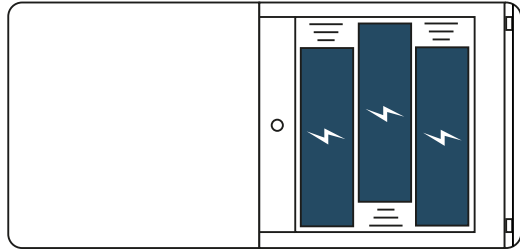

Battery

When the batteries begin to run low, the lock will emit a signal during use by the user. The red indicator will flash and 8 beeps will sound to indicate that the batteries need to be replaced.

Charger

If the batteries are exhausted, a 6V emergency battery charger can be used. Insert the battery plug into the lock's power port, then enter the code or swipe the card on the magnetic reader to unlock.